

# ROUTINE

*MWO effective date is 14 October 2008 and completion date is 2013.*

MWO 5-2350-262-35-4

## MODIFICATION WORK ORDER

---

### MODIFICATION OF ARMORED COMBAT EARTHMOVER (ACE), M9

(NSN 2350-00-808-7100) (EIC ASA)  
SYSTEM IMPROVEMENT PLAN (SIP)  
PHASE 4 BLOCK MODIFICATION

---

HEADQUARTERS, DEPARTMENT OF THE ARMY, WASHINGTON, D.C

14 DECEMBER 2008

#### REPORTING ERRORS AND RECOMMENDING IMPROVEMENT

You can help improve this MWO. If you find any mistakes, or if you know of a way to improve the procedures, please let us know. Mail your DA Form 2028 (Recommended Changes to Equipment Technical Publications), through the Internet, on the Army Electronic Product Support (AEPS) website. The internet address is <https://aeaps.us.army.mil>. The DA Form 2028 is located under the Public Applications section in the AEPS Public Home Page. Fill out the form and click on SUBMIT. Using this form on the AEPS will enable us to respond quicker to your comments and better manage the DA Form 2028 program. You may also mail, fax or E-mail your letter or DA Form 2028 direct to: AMSTA-LC-LMPP/ TECH PUBS, TACOM-RI., Rock Island Arsenal, Rock Island, IL 61299-7630. The email address is [tacomlcmc.daform2028@us.army.mil](mailto:tacomlcmc.daform2028@us.army.mil). The fax number is 793-0726 or Commercial (309)782-0726.

**DISTRIBUTION STATEMENT A:** APPROVED FOR PUBLIC RELEASE; DISTRIBUTION IS UNLIMITED.



MODIFICATION WORK ORDER  
No. 5-2350-262-35-4

HEADQUARTERS  
DEPARTMENT OF THE ARMY  
WASHINGTON D.C., 14 DECEMBER 2008

Modification Work Order

Modification Of Armored Combat Earthmover  
(Ace), M9

(NSN 2350-00-808-7100) (EIC ASA)  
System Improvement Plan (SIP)  
Phase 4 Block Modification

**TABLE OF CONTENTS**

	<u>Page</u>
<b>CHAPTER 1</b>	<b>INTRODUCTION ..... 1-1</b>
	MWO KITS/PARTS AND THEIR DISPOSITION ..... 1-3
	SPECIAL TOOLS; TOOL KITS; JIGS; TEST, MEASUREMENT, AND DIAGNOSTIC EQUIPMENT (TMDE); AND FIXTURES REQUIRED ..... 1-10
<b>CHAPTER 2</b>	<b>MODIFICATION OF DRIVER'S COMPARTMENT ..... 2-1</b>
SECTION I	PREPARATION FOR MODIFICATION ..... 2-2
SECTION II	INSTALLATION OF HDC CONTROL BOX STOWAGE FIXTURE ..... 2-3
SECTION III	INSTALLATION OF HDC CIRCUIT BREAKER ..... 2-7
SECTION IV	INSTALLATION OF UMBILICAL CABLE DISCONNECT BRACKET ..... 2-8
<b>CHAPTER 3</b>	<b>MODIFICATIONS IN BOWL AREA ..... 3-1</b>
SECTION I	PREPARATION FOR MODIFICATION ..... 3-2
SECTION II	INSTALLATION OF HDC PRIMARY MANIFOLD ASSEMBLY, MANUAL SHUT-OFF VALVE V23, AND LEFT MAIN MANIFOLD PRESSURE TRANSDUCER T7 ..... 3-3
SECTION III	MODIFICATION OF MAIN HYDRAULIC FILTER AREA ..... 3-53
SECTION IV	INSTALLATION OF PRESSURE TRANSDUCER T12 ..... 3-67
SECTION V	MODIFICATION OF ACCESS COVER ..... 3-68
SECTION VI	INSTALLATION OF BUMP STOP CYLINDERS PRESSURE TRANSDUCERS T8 AND T9 ..... 3-70
SECTION VII	INSTALLATION OF FORWARD ACTUATORS PRESSURE TRANSDUCERS T5 AND T6 ..... 3-72
<b>CHAPTER 4</b>	<b>MODIFICATIONS TO UNDERSIDE OF VEHICLE ..... 4-1</b>
SECTION I	PREPARATION FOR MODIFICATION ..... 4-2
SECTION II	INSTALLATION OF NEW FORWARD LEFT MANIFOLD ASSEMBLY ..... 4-4
SECTION III	INSTALLATION OF NEW FORWARD RIGHT MANIFOLD ASSEMBLY ..... 4-14
SECTION IV	INSTALLATION OF AFT MANIFOLD ASSEMBLY ..... 4-23

**TABLE OF CONTENTS - CONTINUED**

	<u>Page</u>
<b>CHAPTER 5</b>	
<b>MODIFICATIONS TO VEHICLE ELECTRICAL SYSTEM TO PROVIDE ELECTRICAL INTERFACE AND POWER TO HDC SYSTEM</b> .....	<b>5-1</b>
SECTION I PREPARATION FOR MODIFICATION .....	5-2
SECTION II INSTALLATION AND PRELIMINARY ROUTING OF HDC CABLE ASSEMBLIES .....	5-3
SECTION III ELECTRICAL CONNECTION OF HDC CIRCUIT BREAKER .....	5-11
SECTION IV ROUTING AND ELECTRICAL CONNECTION OF POWER CABLE ASSEMBLY W1 .....	5-13
SECTION V ROUTING AND ELECTRICAL CONNECTION OF UPPER CABLE ASSEMBLY W2 .....	5-17
SECTION VI ROUTING AND ELECTRICAL CONNECTION OF LOWER CABLE ASSEMBLY W3 .....	5-22
SECTION VII MODIFICATION COMPLETION .....	5-27
<b>APPENDIX A</b>	
<b>M9 ACE HDC MWO CHECK-OUT PROCEDURE</b> .....	<b>A-1</b>
<b>APPENDIX B</b>	
<b>HULL/EJECTOR INTERFERENCE MODIFICATION</b> .....	<b>B-1</b>



## LIST OF FIGURES

	<u>Page</u>
Figure 2-1. Mounting Hole Locations for Control Box Stowage Fixture . . . . .	2-4
Figure 2-2. HDC Control Box Stowage Fixture Installation . . . . .	2-5
Figure 2-3. HDC Control Box Stowaged . . . . .	2-6
Figure 2-4. HDC Circuit Breaker Installation, Rear View . . . . .	2-7
Figure 2-4. HDC Circuit Breaker Installation, Top View (Shown With Wiring and Umbilical Cable Disconnect Bracket Installed) . . . . .	2-7
Figure 2-5. Driver's Compartment Area for Installation of Umbilical Cable Disconnect Bracket . . . . .	2-8
Figure 2-6. HDC Umbilical Cable Disconnect Bracket Mounting Hole Locations . . . . .	2-9
Figure 2-7. Umbilical Cable Disconnect Bracket Installation . . . . .	2-10
Figure 3-1. Components to be Removed from DCV Bank - Split Flange Assembly . . . . .	3-4
Figure 3-2. Components to be Removed and/or Replaced on DCV Bank . . . . .	3-6
Figure 3-3. Components to be Replaced - Clamp Assembly . . . . .	3-7
Figure 3-4. Components to be Removed and/or Replaced - DCV Bank and Suspension Valve Mounting Brackets . . . . .	3-8
Figure 3-5. Components to be Removed in Lower Bowl Area Near Left Main Manifold . . . . .	3-9
Figure 3-6. Primary Manifold Assembly, Bottom, Rear and End View . . . . .	3-11
Figure 3-7. Primary Manifold Assembly, Top, Front and End View . . . . .	3-13
Figure 3-8. Primary Manifold Assembly, Top View . . . . .	3-14
Figure 3-9. Primary Manifold Assembly Hydraulic Schematic Diagram . . . . .	3-15
Figure 3-9. Primary Manifold Assembly Hydraulic Schematic Diagram . . . . .	3-16
Figure 3-9. Primary Manifold Assembly Hydraulic Schematic Diagram . . . . .	3-18
Figure 3-9. Primary Manifold Assembly Hydraulic Schematic Diagram . . . . .	3-20
Figure 3-9. Primary Manifold Assembly Hydraulic Schematic Diagram . . . . .	3-22
Figure 3-9. Primary Manifold Assembly Hydraulic Schematic Diagram . . . . .	3-24
Figure 3-10. Location of Solenoid Valves V11 and V15 . . . . .	3-25
Figure 3-11. Rear View of Manifold with Coil Removed . . . . .	3-25
Figure 3-12. Installation of Mounting Plate on Primary Manifold Assembly . . . . .	3-26
Figure 3-13. Installation of Clamp Assembly on Inbound Angle Bracket . . . . .	3-27
Figure 3-14. Installation of Mounting Brackets . . . . .	3-28
Figure 3-15. Mounting and Installation of HDC Primary Manifold Assembly . . . . .	3-29
Figure 3-16. Attaching Outboard Weldment Bracket to Primary Manifold Assembly . . . . .	3-30
Figure 3-17. Installation of Primary Manifold Brace . . . . .	3-31
Figure 3-18. Installation of Upper Portion of Brace . . . . .	3-32
Figure 3-19. Modifications to DCV Bank . . . . .	3-33
Figure 3-20. Manual Shut-Off Ball Valve V23 Installation . . . . .	3-34
Figure 3-21. DCV Bank Mounting Connections . . . . .	3-35
Figure 3-22. Mounting of DCV Bank and Suspension (Sprung/Unsprung) Valve/Upper View) . . . . .	3-36
Figure 3-23. Mounting of DCV Bank and Suspension (Sprung/Unsprung) Valve/Lower View . . . . .	3-37
Figure 3-24. Installation of HDC Primary Manifold Assembly Hydraulic Tubes and Hoses . . . . .	3-39
Figure 3-25. Identification of HDC Primary Manifold Assembly Ports . . . . .	3-39
Figure 3-26. Installation of HDC Primary Manifold Assembly Hydraulic Tubes and Hoses . . . . .	3-41
Figure 3-27. Left Main Manifold Porting (Before Modification) . . . . .	3-44
Figure 3-28. Installation of Hydraulic Hose 13214E2457-18 . . . . .	3-45
Figure 3-29. Installation of Left Main Manifold Pressure Transducer T7 . . . . .	3-46
Figure 3-30. Pressure Relief Valve and Associated Components Interconnection Before Modification . . . . .	3-48
Figure 3-31. Interconnection of Components After Modification . . . . .	3-49
Figure 3-32. HDC Primary Manifold Assembly Hydraulic Interconnection . . . . .	3-51
Figure 3-33. Circuit 19 (Forward) and Circuit 20 (Rear) Tee Orientation . . . . .	3-52

## LIST OF FIGURES - CONTINUED

	<u>Page</u>
Figure 3-34. Components to be Removed/Relocated in Main Pump Filter Area .....	3-53
Figure 3-35. Manual Ball Valve Modification, Right Filter Area .....	3-55
Figure 3-36. Hydraulic Filter Mounting Plates Shown Installed .....	3-56
Figure 3-37. Modifications to Main Pump Right Hydraulic Filter Area (Left Side Shown) .....	3-58
Figure 3-38. Manual Ball Valve Modification, Left Filter Area .....	3-61
Figure 3-39. Modificaitons to Main Pump Left Hydraulic Filter Area .....	3-63
Figure 3-40. Modification to Main Pump Hydraulic Filter Area .....	3-65
Figure 3-41. Valve Components Shown Installed in Support Bracket .....	3-65
Figure 3-42. Installation of Modified Main Pump Hydraulic Filter Assemblies .....	3-66
Figure 3-43. Installation of Pressure Transducer T12 .....	3-67
Figure 3-44. Location of Access Cover .....	3-68
Figure 3-45. Modification to Access Cover .....	3-69
Figure 3-46. Installation of Right Side Bump Stop Cylinder Pressure Transducer T8 .....	3-70
Figure 3-47. Installation of Left Side Bump Stop Cylinder Pressure Transducer T9 .....	3-71
Figure 3-48. Installation of Pressure Transducer T5 .....	3-72
Figure 3-49. Installation of Pressure Transducer T6 .....	3-73
Figure 4-1. Existing Forward Left Manifold Assembly (Being Replaced) .....	4-4
Figure 4-2. Forward Left Manifold Assembly .....	4-7
Figure 4-3. Forward Left Manifold Hydraulic Schematic Diagram .....	4-8
Figure 4-4. Installation of New Forward Left Manifold Assembly .....	4-10
Figure 4-5. Identification of Forward Left Manifold Assembly Ports .....	4-11
Figure 4-6. Installation and Interconnection of New Forward Left Manifold Assembly .....	4-13
Figure 4-7. Existing Forward Right Manifold Assembly (Being Replaced) .....	4-14
Figure 4-8. Forward Right Manifold Assembly .....	4-16
Figure 4-9. Forward Right Manifold Hydraulic Schematic Diagram .....	4-17
Figure 4-9. Forward Right Manifold Hydraulic Schematic Diagram .....	4-18
Figure 4-10. Installation of New Forward Right Manifold Assembly .....	4-19
Figure 4-11. Identification of Forward Right Manifold Assembly Ports .....	4-20
Figure 4-12. Installation and Interconnection of New Forward Right Manifold Assembly .....	4-22
Figure 4-13. Aft Manifold Assembly .....	4-25
Figure 4-14. Aft Manifold Hydraulic Schematic Diagram .....	4-26
Figure 4-15. Mounting and Installation of Aft Manifold on 1" (2.54 cm) Thick Hull .....	4-28
Figure 4-16. Interconnection of Aft Manifold Assembly on 1" Thick Hull Bottom .....	4-30
Figure 4-17. Identification of Aft Manifold Assembly Ports .....	4-30
Figure 5-1. Initial Placement of Upper Cable Assembly W2 .....	5-3
Figure 5-2. Cable Connector Installation Orientation (Typical) .....	5-4
Figure 5-3. Typical Cable Connector Installation .....	5-5
Figure 5-3. Typical Cable Connector Installation .....	5-6
Figure 5-4. Placement of Upper Cable Assembly W2 .....	5-7
Figure 5-5. Initial Placement of Lower Cable Assembly W3 .....	5-9
Figure 5-6. Initial Routing of Power Cable Assembly W1 .....	5-10
Figure 5-7. Connection of HDC Power Distribution Components .....	5-11
Figure 5-8. Parking Brake Relay Terminals .....	5-12
Figure 5-9. HDC Power Cable Assembly W1 Connection to Parking Brake Relay .....	5-13
Figure 5-10. Routing of Cable Assembly W1 Branch 1069 From Disconnect Bracket .....	5-14
Figure 5-11. Routing of Cable Assembly W1 Branch 1069 to Compartment Wall .....	5-15
Figure 5-12. Upper Cable Assembly W2 Routing .....	5-17
Figure 5-12. Upper Cable Assembly W2 Routing .....	5-20
Figure 5-13. Electrical Connections on Primary Manifold Assembly .....	5-21
Figure 5-14. Lower Cable Assembly W3 Routing .....	5-22

## LIST OF FIGURES - CONTINUED

	<u>Page</u>
Figure 5-15. Electrical Connections on Forward Left Manifold Assembly .....	5-25
Figure 5-16. Electrical Connections on Forward Right Manifold Assembly .....	5-25
Figure 5-17. Electrical Connections on Aft Manifold Assembly .....	5-26
Figure 5-18. Access Cover Location .....	5-28
Figure 5-19. HDC Control Box .....	5-29
Figure 5-20. Umbilical Cable Assembly W4 Connection to Umbilical Cable Disconnect Bracket .....	5-30
Figure 5-21. Umbilical Cable Assembly W4 Connections to HDC Control Box .....	5-30
Figure B-1. Dimensional Drawing for Fabricating Wheel Support Wedge .....	B-1
Figure B-2. Dimensional Drawing for Fabricating Ejector Cylinder Mount Spacer Plate .....	B-2
Figure B-3. Right and Left Side Wheel Support Wedge Locations .....	B-3
Figure B-4. Wheel Support Wedge Welded in Position .....	B-4
Figure B-5. Ejector Cylinder Bracket Removal .....	B-5
Figure B-6. Spacer Block Installed .....	B-6

## LIST OF TABLES

Table 1-1. Driver's Compartment Modification Kit Parts List .....	1-3
Table 1-1. Driver's Compartment Modification Kit Parts List - Continued .....	1-3
Table 1-2. Bowl Area Modification Kit Parts List .....	1-3
Table 1-2. Bowl Area Modification Kit Parts List - Continued .....	1-4
Table 1-2. Bowl Area Modification Kit Parts List - Continued .....	1-5
Table 1-2. Bowl Area Modification Kit Parts List - Continued .....	1-6
Table 1-3. Primary Manifold Parts List .....	1-6
Table 1-4. Vehicle Underside Modification Kit Parts List .....	1-7
Table 1-5. Forward Left Manifold Parts List .....	1-7
Table 1-6. Forward Right Manifold Parts List .....	1-8
Table 1-7. Aft Manifold Parts List .....	1-8
Table 1-8. Electrical Modification Kit Parts List .....	1-9
Table 1-9. Bulk and Expendable Material Modification Kit Parts List .....	1-10
Table 1-10. Common Tools Required .....	1-10
Table 1-11. Special Tools Required .....	1-10
Table 1-12. Test Equipment Required .....	1-11
Table 3-1. HDC Primary Manifold Assembly Hydraulic Connections .....	3-42
Table 3-1. HDC Primary Manifold Assembly Hydraulic Connections - Continued .....	3-43
Table 4-1. Interconnection of New Forward Left Manifold Assembly Hydraulic Hoses and Tubes .....	4-12
Table 4-2. Interconnection of New Forward Right Manifold Assembly Hydraulic Hoses and Tubes .....	4-21
Table 4-3. Interconnection of Aft Manifold Assembly Hydraulic Hoses .....	4-31
Table 5-1. Upper Cable Assembly W2 Electrical Connections .....	5-18
Table 5-1. Upper Cable Assembly W2 Electrical Connections - Continued .....	5-19
Table 5-2. Lower Cable Assembly W3 Electrical Connections .....	5-23
Table 5-2. Lower Cable Assembly W3 Electrical Connections - Continued .....	5-24
Table B-1. Hull/Ejector Interference Modification Parts List .....	

## LIST OF FOLDOUTS

FO 3-1. M9 ACE HDC Hydraulic Schematic (Sheet 1 of 3) .....	FP-1
FO 3-1. M9 ACE HDC Hydraulic Schematic (Sheet 2 of 3) .....	FP-3
FO 3-1. M9 ACE HDC Hydraulic Schematic (Sheet 3 of 3) .....	FP-5
FO 3-2. Filter Area - Front Compartment Plate Modifications .....	FP-7
FO 4-1. Mounting the Aft Manifold .....	FP-9

**MWO 5-2350-262-35-4**

FO 5-1	Upper Cable Assembly W2 .....	FP-11
FO 5-2	Lower Cable Assembly W3 .....	FP-13
FO 5-3	Power Cable Assembly W1 .....	FP-15
FO 5-4	Simplified Electrical Schematic Diagram of HDC System Power Distribution .....	FP-17
FO 5-5	HDC System Electrical Interconnection Diagram .....	FP-19
FO 5-6	Umbilical Cable Assembly W4 .....	FP-21
FO B-1	Wedge, Wheel Support .....	FP-23
FO B-2	Spacer Plate Ejector Cylinder Mount .....	FP-25

## CHAPTER 1 INTRODUCTION

### 1-1 PURPOSE.

This Modification Work Order (MWO) provides the M9 Armored Combat Earthmover (ACE) with improved on-vehicle capabilities to troubleshoot the vehicle's hydraulic system. Modifications to the vehicle incorporate diagnostic hardware designed to facilitate maintenance by using the Hydraulic Diagnostic Center (HDC).

### 1-2 PRIORITY.

This modification is classified ROUTINE.

### 1-3 END ITEM TO BE MODIFIED.

Nomenclature	NSN	Part Number	CAGEC	Model Number	Serial Number
Armored Combat Earthmover (ACE), M9	2350-00-808-7100	TA13211E8600	97403	M9 ACE	All

### 1-4 COMPONENTS TO BE MODIFIED.

Not applicable.

### 1-5 PARTS TO BE MODIFIED.

See applicable chapter.

### 1-6 APPLICATION.

- a. Time compliance schedule: MWO effective date is 29 August 2008 and completion date is 2013.
- b. The lowest level of maintenance authorized to apply this MWO: Direct Support (DS).

**1-6 APPLICATION. - CONTINUED**

- c. Work Force/Skills and hour requirements for application of this MWO to a single unit, end item, or system are as follows:

**REQUIREMENTS**

WORK FORCE/SKILLS	MAN-HOURS
Construction Equipment Repair (62B10)	
1. Modifications to Driver's Compartment (CH. 2)	10
2. Modifications in Bowl Area (CH. 3)	64
3. Modifications to Underside of Vehicle (CH. 4)	20
4. Modifications to Provide Power to HDC (CH. 5)	14
5. Assembly of Primary Manifold	2
6. Primary Manifold Functionality Testing	1
7. Assembly of Right Forward Manifold	0.5
8. Right Forward Manifold Functionality Testing	0.5
9. Assembly of Left Forward Manifold	0.5
10. Left Forward Manifold Functionality Testing	0.5
11. Assembly of Aft Manifold	0.5
12. Aft Manifold Functionality Testing	0.5
13. Hull/Ejector Interference Modification (Appendix B)	1.0
Total man-hours required for a single application of this MWO is 124 hours.	

- d. MWOs to be applied prior to or concurrently with the application of this MWO: Not applicable.
- e. Additional information deemed necessary to assist in the application of this MWO:

**PUBLICATIONS:**

AR 750-10  
DA Pam 738-750

TM 750-245-4

DA Pam 738-751

**1-7 TECHNICAL PUBLICATIONS AFFECTED/CHANGED.**

**PUBLICATIONS**

TM 5-2350-262-10, dated June 1992, with Change 7, dated June 2007

TM 5-2350-262-20-1, dated January 1997, with Change 4, dated July 2007

TM 5-2350-262-20-2, dated January 1997, with Change 4, dated July 2007

TM 5-2350-262-20-3, dated January 1997, with Change 4, dated July 2007

TM 5-2350-378-24&P

## 1-8 MWO KITS/PARTS AND THEIR DISPOSITION.

- a. Tables 1-1 through 1-8 reflect kits/parts associated with Chapters 2 through 5.

**Table 1-1. Driver's Compartment Modification Kit Parts List**

Part No.	CAGE	NSN	Description	Qty
<b>NEW PARTS</b>				
MS51831-102	96906	5325-00-451-8982	Insert, Screw Thread	4
12496932	19207	2590-01-536-1519	Pad, Rubber, 4-inch Strip	2
10917219	19207	5310-00-815-1073	Nut, Wing (Nut, Self-Locking, Wing)	2
NAS1454C4A-0504	80205	5307-01-536-0580	Threaded Rod	2
12496933	19207	5340-01-536-3813	Retainer, HDC Control Box	1
MS51967-2	96906	5310-00-761-6882	Nut, Jam (Nut, Plain, Hexagon)	2
MS27183-50	96906	5310-00-285-8124	Washer, Flat	4
12496928-4	19207	9905-01-540-7804	Marker, HDC Control Box	1
12496937	19207	6110-01-537-8428	Control Box, HDC	1
AA55571/01-001	58536	5925-01-430-2318	Circuit Breaker	1
12496964	19207	2590-01-536-3813	Plate, Disconnect (Bracket, Umbilical Cable Disconnect)	1
MS35206-249	80205	5305-00-984-6197	Screw, Machine	2
MS35333-38	80205	5310-00-559-0070	Washer, Lock	2
MS35649-282	80205	5310-00-934-9757	Nut, Plain, Hexagonal	2
B1821BH025C075L	80204	5306-01-175-7558	Screw, Locking	2
<b>REMOVE/RELOCATE (TO BE RE-INSTALLED)</b>				
N/A	-----	N/A	Switch Panel (position temporarily shifted for accessibility)	1
N/A	-----	N/A	Seat, Driver's	1
<b>REMOVE AND DISCARD</b>				
These mandatory replacement parts are replaced with new parts that are installed in Chapter 5, Section 7.	-----	-----	-----	----- -
B1821BH038C100L	80204	5306-01-114-0963	Screw, Self-Locking (from removal of seat assembly)	4
MS17829-5C	80205	5310-00-245-3424	Locknut (from moving parking brake)	2

**Table 1-2. Bowl Area Modification Kit Parts List**

Part No.	CAGE	NSN	Description	Qty
<b>NEW PARTS</b>				
12496959	19207	5340-01-536-1486	Plate, Mounting, Primary Manifold	1
B1821BH038C100L	80204	5306-01-114-0963	Screw, Locking	22
10910174-3	19200	5310-00-877-5972	Washer, Flat	23
12496952	19207	5340-01-536-2060	Angle Bracket, Steel (inboard)	1
B1821BH050C113L	80204	5306-01-205-2799	Screw, Locking	8

## 1-8 MWO KITS/PARTS AND THEIR DISPOSITION. - CONTINUED

Table 1-2. Bowl Area Modification Kit Parts List - Continued

Part No.	CAGE	NSN	Description	Qty
12496944	19207	2590-01-537-2318	Weldment, Bracket, Main Control Valve Bank (outboard)	1
B1821BH038C125N	80204	5305-00-068-0511	Screw (attaches 12496952 to 12496944)	2
MS17829-6C	80204	5310-00-483-8790	Nut, Self-Locking	10
12496927	19207	5340-01-536-4160	Bracket, Angle (lower lateral support bracket)	1
12496924	19207	5340-01-536-7170	Brace (lateral support bracket)	1
B1821BH050C250N	80204	5305-00-543-2866	Screw	1
10910174-5	19200	5310-00-866-4417	Washer, Flat	3
MS17829-8C	80204	5310-00-565-4287	Nut, Self-Locking	1
B1821BH038C200L	80204	5306-01-194-0591	Screw, Locking	2
10910174-3	19200	5310-00-877-5972	Washer, Flat	2
MS51521A8	96906	4730-00-812-2434	90-Degree Swivel, -8 (for left main manifold ports 3L, 3R, 17L and 17R) - Tube, Elbow	4
8AOEX6	30780	4730-01-536-9912	Adapter, 90-Degree, Swivel, -8	1
BVHP-08-SSS-1NG	09990	4820-01-536-6135	Valve, Ball	3
MS51527A8	96906	4730-00-822-5609	Adapter, 90 degree, -8	1
MS51525B10	96906	4730-00-623-3889	Adapter, Straight, -10 (for port 21 of DCV bank)	1
MS28778-10	96906	5331-01-306-9602	O-Ring, -10	1
MS51528B8	96906	4730-00-062-5470	Elbow, 45 degrees, -8	1
MS28775-219	80204	5331-00-579-7925	O-Ring for Split Flange on Back of Valve Bank	1
B1821BH038C125L	80204	5306-01-112-8681	Screw, Locking	4
MS24665-132	80204	5315-00-839-2325	Cotter Pin (to attach mechanical control linkages)	7
12496940	19207	4710-01-543-0840	Tube, Main Manifold, Small	4
12496939	19207	4710-01-543-3416	Tube, Main Manifold, Diagonal	1
MS51521A10	96906	4730-01-139-1585	90-Degree Swivel, -10	2
12496963	19207	4710-01-543-5071	Tube, Main Manifold, Diagonal, Small	1
12496941	19207	4710-01-543-3418	Tube, Main Manifold, Large	1
8-4XHX6G5TP	30780	4730-01-537-0516	Adapter, Diagnostic Tee, -8	6
MS28778-4	96906	5330-01-331-8137	O-Ring, -4	8
12496923	19207	6695-01-536-2040	Pressure Transducer	8
MS51525B8	96906	4730-00-853-1182	Elbow, Tube to Boss	6
MS28778-8	96906	5331-00-808-0794	O-Ring, -8	19
MS51523B8	96906	4730-00-064-3881	Tee, Swivel Nut, Run -8	2
8WF5OX	30780	4730-01-536-8399	Adapter, Bulkhead -8	2
10910174-8	19200	5310-00-877-7527	Washer, Flat	4
8F650X-SS	30780	4730-01-441-9417	Adapter, Swivel -8	6
13211E9018-12	19207	4730-00-225-0699	Adapter, 90 degree (elbow, tube to hoses), -8, -6	2



## 1-8 MWO KITS/PARTS AND THEIR DISPOSITION. - CONTINUED

Table 1-2. Bowl Area Modification Kit Parts List - Continued

Part No.	CAGE	NSN	Description	Qty
8-6 ETX-S	30780	4730-01-284-2195	Union Elbow -8, -6	2
13214E2501-12	97403	4720-01-536-7713	Hose Assembly - Relief Bypass	2
1A30-01-V-8ST1-D-430	8Z296	4820-01-550-0151	Relief Valve	1
MS51831-104	96906	5325-01-066-2840	Insert - Vehicle Bulkhead	9
MS28778-4	96906	5330-01-331-8137	O-Ring	8
12496966	19207	5340-01-536-3775	Bracket, Subplate, Filter Area (hydraulic filter mounting plate)	2
B1821BH038C150L	80204	5306-01-119-6763	Screw, Locking	6
12496967	19207	5340-01-541-5407	Bracket, Filter Area Bulkhead (ball valve support bracket)	2
MS27183-14	80204	5310-00-080-6004	Washer, Flat	4
B1821BH038C450L	80204	5305-00-857-6886	Screw, Locking (from filter assembly removal)	4
6-4XHX6G5TP	30780	4730-01-536-8749	Adapter, Diagnostic Tee, -6	2
12273559	19207	4330-01-461-1597	Element, Filter	2
13214E2457-18	97403	4720-01-536-9957	Hose Assembly	1
13214E2457-19	97403	4720-01-536-6252	Hose Assembly	1
12496929	19207	9905-01-541-1785	Band Marker Kit, Bowl Area	1 Kit
12496928-1	19207	7690-01-540-2182	Marker, Manual Valve V21	1
12496928-2	19207	7690-01-540-0945	Marker, Manual Valve V22	1
12496928-3	19207	7690-01-540-1088	Marker, Manual Valve V23	1
MS51860-56Z	96906	4730-01-143-9017	Lock Nut, Bulkhead	1
<b>MOVE/REMOVE/RELOCATE (TO BE RE-INSTALLED)</b>				
13204E2549	97403	5340-01-179-4110	Assembly, Clamp	1
MS27183-18	96906	5310-00-809-5998	Washer, Flat	5
MS51521A10	96906	4730-01-139-1585	Elbow (from DCV bank ejector valve port 21)	1
B1821BH038C150N	80204	5305-00-725-2317	Screw, Hex Cap	4
MS27183-14	96906	5310-00-080-6004	Washer, Flat	4
12379480	19207	2990-01-375-0195	Guard, Filter (removed and repositioned)	1
1A30-01-V-8S-E-D	8Z296	4820-01-158-4066	Relief Valve (relocated from behind left main manifold for use with left side filter assembly)	1
12332229	19207	5340-01-183-2776	Cover, Access	1
VD-00789-12W1	60047	4330-01-375-1511	Filter, Main Pump (removed, and repositioned)	2
MS27183-18	96906	5310-00-809-5998	Washer, Flat	5
<b>REMOVE AND DISCARD</b>				
13211E9561	97403	2590-01-179-7527	Bracket, Valve (inboard)	1
13211E9562	97403	2590-01-179-7528	Bracket, Valve (outboard)	1
13214E2764	97403	5340-01-195-5914	Bracket, Angle (replaced by 12496927 for attaching brace)	1

## 1-8 MWO KITS/PARTS AND THEIR DISPOSITION. - CONTINUED

Table 1-2. Bowl Area Modification Kit Parts List - Continued

Part No.	CAGE	NSN	Description	Qty
MS51526A10	96906	4730-01-192-9590	Adapter, Straight, -10 (from DCV bank port 21)	1
AC-1-310	46717	4730-01-156-4835	Adapter, -8 Boss to Tube on DCV Port 21	1
MS51521A8	96906	4730-00-812-2434	Elbow, Tube, -8, on DCV bank Ports 22 and C1	2
MS28775-219	80204	5331-00-579-7925	O-Ring (from split flange on back of DCV bank)	1
MS24665-132	80204	5315-00-839-2325	Pin, Cotter (from DCV bank and suspension valves control linkages)	7
MS28778-10	96906	5331-01-306-9602	O-Ring, -10 (from port 21 of DCV bank)	1
MS28778-8	96906	5331-00-808-0794	O-Ring, -8 (from port C1 of DCV bank winch valve)	1

Table 1-3. Primary Manifold Parts List

Part No.	CAGE	NSN	Description	Qty
12496925	19207	4810-01-536-2997	Valve, Normally Open	3
12496926	19207	4810-01-536-6609	Valve, Normally Closed	2
12496936	19207	4810-01-536-5871	Valve, 3-way	6
12496923	19207	6695-01-536-2040	Transducer, Pressure	3
12496935	19207	4730-01-536-3025	Manifold, Primary	1
MS28778-4	96906	5330-01-331-8137	O-ring, -4	11
12335054-2	19207	5365-01-200-1519	Plug	5
12335054-5	19207	5365-01-228-0730	Plug	6
MS28778-8	96906	5331-00-800-0794	O-ring, -8	21
AC-1-310	46717	4730-01-156-4835	Adapter, Straight	11
MS28778-10	96906	5331-00-306-9602	O-ring, -10	2
MS51526A-10	96906	4730-01-192-9590	Adapter, Straight	1
MS51527A-8	96906	4730-00-822-5609	Adapter, 90-degree	3
1A30-01-V-0-E-D-304	8Z296	4820-00-550-6786	Valve, Relief	1
MS51528A10	96906	4730-00-936-2172	Adapter, 45-degree	1
MS51528A8Z	96906	4730-01-236-2682	Adapter, 45-degree	1
12335054-4	19207	5365-01-242-4564	Plug	1
MS28778-6	81343	5331-00-804-5695	O-ring	1
MS51521A8	96906	4730-00-812-2434	Elbow, Tube	1
MS28775-118	81343	5331-01-514-0923	O-ring	11
MS27595-019	96906	5330-01-118-5705	Teflon Backup	12
MS28775-019	96906	5331-00-551-8441	O-ring	8
MS28778-12	81343	5331-00-251-8839	O-ring	6
MS28774-019	96906	5330-00-720-3652	Teflon Backup	12
MS28774-018	96906	5330-00-839-1846	Teflon Backup	12

## 1-8 MWO KITS/PARTS AND THEIR DISPOSITION. - CONTINUED

Table 1-4. Vehicle Underside Modification Kit Parts List

Part No.	CAGE	NSN	Description	Qty
<b>NEW PARTS</b>				
B1821BH038C250L	80204	5306-01-253-4428	Screw, Locking	4
10910174-3	19200	5310-00-877-5972	Washer, Flat	7
MS51831-104	96906	5325-01-066-2840	Inserts	3
B1821BH038C325L	80204	5305-01-449-7391	Screw, Locking	3
13214E2495-6	97403	4720-01-536-8024	Hose Assembly, Aft Manifold (New Hose)	1
MS51521A6	96906	4730-00-618-5372	Swivel, 90-Degree Elbow, Tube	2
13214E2501-11	97403	4720-01-446-7548	Hose Assembly, Aft Manifold (New Hose)	1
13214E2486-2	97403	4720-01-536-8728	Hose Assembly, Aft Manifold (New Hose)	1
12496969	19207	9905-01-541-1786	Band Marker Kit, Underside	1 Kit
<b>REMOVE AND DISCARD</b>				
B1821BH038C200L	80204	5306-01-194-0591	Screw, Locking	4
13214E2736-1	97403	4730-01-180-8605	Forward Left Manifold Assembly	1
13214E2736-2	97403	4730-01-180-8606	Forward Right Manifold Assembly	1

Table 1-5. Forward Left Manifold Parts List

Part No.	CAGE	NSN	Description	Qty
12496948	19207	4730-01-536-5726	Forward Left Manifold	1
MS51527A4	96906	4730-00-585-2309	Elbow, 90-degree	2
13211E8916-1	19207	4730-00-062-5470	Elbow- 45-degree	1
MS28778-4	96906	5330-01-331-8137	O-ring, -4	3
MS28778-8	96906	5331-00-808-0794	O-ring, -8	2
13211E8916-6	19207	4730-00-679-9766	Elbow, 45-degree	1
MS28778-6	96906	5331-00-804-5695	O-ring	4
MS51527A6	96906	4730-00-143-3941	Elbow, 90-degree	1
MS51525A6	96906	4730-00-491-9576	Adapter, Straight	2
AC-1-310	46717	4730-01-156-4835	Adapter, Straight	1
12496925	19207	4810-01-536-2997	Valve	2
12496923	19207	6695-01-536-2040	Transducerd, Pressure	1
MS27595-019	96906	5330-01-118-5705	Teflon Backup	4
MS28775-019	96906	5331-00-551-8441	O-ring	2
MS28775-118	81343	5331-01-514-0923	O-ring	2

## 1-8 MWO KITS/PARTS AND THEIR DISPOSITION. - CONTINUED

Table 1-6. Forward Right Manifold Parts List

Part No.	CAGE	NSN	Description	Qty
12496934	19207	4730-01-536-2677	Forward Right Manifold	1
MS51525A6	96906	4730-00-491-9576	Adapter, Straight	2
MS28778-6	81343	5331-00-804-5695	O-ring	4
MS51527A6	96906	4730-00-143-3941	Adapter, 90-degree	1
MS28778-4	96906	5330-01-331-8137	O-ring, -4	2
MS51527A4	96906	4730-00-585-2309	Adapter, 90-degree	2
13211E8916-6	19207	4730-00-062-5470	Adapter, 45-degree	1
MS28778-8	81343	5331-00-808-0794	O-ring, -8	2
13211E8916-1	19207	4730-00-679-9766	Adapter, 45-degree	1
12496923	19207	6695-01-536-2040	Transducer, Pressure	1
12496925	19207	4810-01-536-2997	Valve, Normally Open	2
AC-1-310	46717	4730-01-156-4835	Adapter, Straight	1
MS28778-4	81343	5331-00-805-2966	O-ring	3
MS28775-118	81343	5331-01-514-0923	O-ring	2
MS27595-019	96906	5330-01-118-5705	Teflon Backup	4
MS28775-019	96906	5331-00-551-8441	O-ring	2

Table 1-7. Aft Manifold Parts List

Part No.	CAGE	NSN	Description	Qty
12496938	19207	4730-01-543-4250	Aft Manifold	1
12496925	19207	4810-01-536-2997	Valve, Normally Open	4
MS51527A6	96906	4730-00-143-3941	Adapter, 90-degree	1
MS28778-6	96906	5331-00-804-5695	O-ring, -6	2
MS28778-8	96906	5331-00-808-0794	O-ring, -8	1
12335054-5	19207	5365-01-228-0730	Plug	1
MS51525A6	96906	4730-00-491-9576	Adapter, Straight	1
MS28778-12	81343	5331-01-219-7930	O-ring, -12	2
MS51525A12	96906	4730-00-710-5571	Adapter, Straight	2
MS28778-4	96906	5330-01-331-8137	O-ring, -4	2
MS51525A4	96906	4730-01-007-5232	Adapter, Straight	1
MS51527A4	96906	4730-00-585-2309	Adapter, 90-degree	1
12496926	19207	4810-01-536-6609	Valve, Normally Closed	1
MS28775-118	81343	5331-01-514-0923	O-ring	5
MS27595-019	96906	5330-01-118-5705	Teflon Backup	10
MS28775-019	96906	5331-00-551-8441	O-ring	5

## 1-8 MWO KITS/PARTS AND THEIR DISPOSITION. - CONTINUED

Table 1-8. Electrical Modification Kit Parts List

Part No.	CAGE	NSN	Description	Qty
<b>NEW PARTS</b>				
12496954	19207	6150-01-536-2129	Upper Cable Assembly (W2)	1
M85049/95-22A	81349	5935-01-354-5345	Nutplate (Plate, Retaining Electrical Connector)	2
D38999/33W23R	81349	5935-01-281-1617	Dustcap (Cover, Electrical Connector)	2
MS24667-4	80205	5305-00-068-5393	Screw, Cap, Socket Head	12
12496955	19207	6150-01-536-3311	Lower Cable Assembly (W3)	1
12496953	19207	6150-01-536-1117	Power Cable Assembly (W1)	1
M85049/95-12A	81349	5935-01-342-9706	Nutplate (Plate, Retaining, Electrical Connector)	1
MS3181-12CA	96906	5935-01-117-6376	Dustcap (Cover, Electrical Connector)	1
8741492	19207	5935-00-807-4109	In-Line Connector (Adapter, Connector)	1
MS27147-1	19207	5935-00-900-6281	"Y" Connector (Adapter, Connector)	1
12496957	19207	6150-01-536-3072	Lead Assembly	1
12496958	19207	6150-01-536-2015	Lead Assembly	1
MS3367-1-9	96906	5975-00-079-2072	Strap, Tie Down, Electrical	12
12496956	19207	6150-01-536-5854	Umbilical Cable Assembly (W4)	1
B1821BH038C100L	80204	5306-01-114-0963	Screw, Self-Locking (for Driver's Seat)	4
MS17829-5C	80205	5310-00-245-3424	Nut, Self-Locking (for Parking Brake)	2
MS51095-360L	80205	5306-01-031-4845	Bolt, Self-Locking (for Trimmed Access Cover)	3
MS25035-154	81343	5940-00-230-0515	Terminal, Lug	1
<b>PREVIOUSLY REMOVED PARTS TO BE RE-INSTALLED</b>				
12332229	19207	5340-01-183-2776	Cover, Access (Modified for HDC Installation)	1

**1-8 MWO KITS/PARTS AND THEIR DISPOSITION. - CONTINUED**

b. Bulk and Expendable Material are as follows:

**Table 1-9. Bulk and Expendable Material Modification Kit Parts List**

Part no.	CAGE	NSN	Description	Qty
M2104-3-10W	81349	9150-00-186-6668	Hydraulic Oil - HDO 10W	
5705562	19207	2590-01-216-8646	Hydraulic Kit	1
13006	1Z575	7930-01-342-5316	Simple Green	1 gal
652000C093171	89875	6520-01-140-5364	Eye Protection	
8415-01-463-5927	80244	8415-01-463-5927	Chemical Gloves Small	1 box
8415-01-463-5934	80244	8415-01-463-5934	Chemical Gloves Medium	1 box
8415-01-463-5928	80244	8415-01-463-5928	Chemical Gloves Large	1 box
AA58092-2-1	58536	8030-00-889-3534	Tape, Teflon 1/4"	1 roll
16030A	84180	8030-00-889-3535	Tape, Teflon 1/2"	1 roll
12A68BT1-51	81755	8040-00-273-8717	Rubberized Adhesive	tube

c. Return removed (no longer required) parts to Unit for disposition or discard as directed.

**1-9 SPECIAL TOOLS; TOOL KITS; JIGS; TEST, MEASUREMENT, AND DIAGNOSTIC EQUIPMENT (TMDE); AND FIXTURES REQUIRED.**

**Table 1-10. Common Tools Required**

Part No.	CAGE	NSN	Description	Qty
SC5180-90-CL-N26	50980	5180-00-177-7033	Tool Kit, General Mechanic's: Automotive	1
SC4910-95CLA31	19204	4910-00-754-0705	Shop Equipment, Automotive Maintenance and Repair: Field Maintenance, Basic, Less Power	1
SC4910-95CLA62	19204	4910-00-754-0706	Shop Equipment, Automotive Maintenance and Repair: Field Maintenance, Supplemental No. 1, Less Power	1

**Table 1-11. Special Tools Required**

Part No.	CAGE	NSN	Description	Qty
-----	---	-----	Hydraulic Test Bench Stand (if available - for setting pressure relief valves). If not available, set pressure relief valves with valve installed on vehicle	1
12355345	19207	2590-01-228-5802	Jack Stands	4ea
12355501	19207	5120-01-222-7934	Hydraulic Tank/Plug	1

## 1-9 SPECIAL TOOLS; TOOL KITS; JIGS; TEST, MEASUREMENT, AND DIAGNOSTIC EQUIPMENT (TMDE); AND FIXTURES REQUIRED. - CONTINUED

Table 1-12. Test Equipment Required

Item No.	Quantity	Description
1	1	Hydraulic Pressure Test Stand - 4000 psig (27579.03 kilopascal), 5 GPM (18927.06 CPM) Minimum capability
2	As Required	Hydraulic Hoses -4, -6, -8, -10 and -12 with 37° Flare Hose fittings
3	3	-4, 37° Flare nut cap
4	3	-6, 37° Flare nut cap
5	14	-8, 37° Flare nut cap
6	2	-10, 37° Flare nut cap
7	2	-12, 37° Flare nut cap
8	1	28 VDC Power Supply, minimum 4.0 amperes capacity
9	1	Multimeter
10	1	15 VDC Power Supply, minimum 4.0 amperes capacity
11	3	Pressure Transducer Test cables with Amp 1.5 Super Seal Connector (5 conductor)
12	4	Solenoid Valve Test cables Amp 1.5 Super Seal Connector (2 conductor)

### 1-10 MODIFICATION PROCEDURES.

See applicable chapter for modification procedures.

### 1-11 CALIBRATION REQUIREMENTS.

Not applicable.

### 1-12 WEIGHT AND BALANCE DATA.

Weight and balance are not significantly affected.

### 1-13 QUALITY ASSURANCE REQUIREMENTS.

- a. General. Quality assurance will be accomplished in accordance with TM 750-245-4.
- b. Physical Inspection. Check components that are removed or installed during the modification for stability of mounting.
- c. Functional Inspection. Start vehicle and ensure that the hydraulic system is operating properly and that all controls and indicators/gauges associated with the hydraulic system properly control their specified hydraulic functions and indicate the correct hydraulic fluid pressures and temperatures in accordance with TM 5-2350-262-10.

**1-14 RECORDING AND REPORTING OF THIS MODIFICATION.**

- a. Records and Reports. The organization responsible for MWO application will report application information as follows:

(1) Reporting will be accomplished by electronic means. MWO application information can be input directly in the Modification Management Information System (MMIS) over the Internet. Entry into the MMIS system is password protected. New users can register on-line at <https://mmis.army.mil>. Passwords are normally approved and issued within 48 hours. If you do not have access to the internet you may send an Excel Spreadsheet with the below information to: [lfilary@us.army.mil](mailto:lfilary@us.army.mil).

(2) Submission will be comprised of the nine (9) data elements listed in the Table below. Elements 1, 2, 8 & 9 are given for this MWO (as shown). The person reporting the MWO data will acquire the remaining elements 3, 4, 5, 6, 7 and input all nine into MMIS.

<u>DATA ELEMENT</u>	<u>INPUT DATA</u>
1. Materiel Change Number (MCN)	1-04-05-0011
2. MWO Number	MWO 5-2350-262-35-4
3. Unit Identifier Code	Software Version
4. NSN of the End Item	
5. Serial Number	
6. USA Registration Number	
7. Date of Application	
8. Hours Required for Application	
9. Software Version	N/A

- b. Records and Reports. Record the modification in accordance with AR 750-10, DA Pam 738-750, and DA Pam 738-751.
- c. Marking Equipment. Stamp “MWO 35-4” on border of existing vehicle data plate 13214E2452.

**1-15 MATERIAL CHANGE (MC) NUMBER.**

This Modification Work Order is authorized by MC number 1-04-05-0011.

**1-16 MODIFICATION IDENTIFICATION.**

See applicable chapters.



## CHAPTER 2

### MODIFICATION OF DRIVER'S COMPARTMENT

**SUBJECT:** Three modifications/additions are made to the driver's compartment: the addition of a stowage fixture for the HDC Control Box, the installation of a circuit breaker, and an umbilical cable disconnect bracket. When not in use, the HDC Control Box may be stowed behind the driver's seat. The circuit breaker is mounted on the new disconnect bracket. The disconnect bracket also provides an interface between the three HDC cable assemblies and the HDC Control Box.

**DATE:** 29 August 2008

**DESCRIPTION:** The stowage fixture for the HDC Control Box consists of a retainer bar anchored to the vehicle wall in back of the driver's seat with two threaded rods, two nuts, two flat washers, and two wing nuts. The umbilical cable disconnect bracket is attached to the left front area of the driver's compartment with two screws and two flat washers. There are some existing parts/components temporarily removed as part of the modifications to the driver's compartment. These parts are re-installed after the modification. A circuit breaker to control application of vehicle power to operate the HDC System is also mounted on the umbilical cable disconnect bracket. The installation and connection of the three HDC vehicle cables to the umbilical cable disconnect bracket is accomplished during the electrical installation performed in Chapter 5.

**TM REFERENCES:** The technical manual references in this procedure are for:

TM 5-2350-262-10, dated June 1992, with Change 7, dated June 2007

TM 5-2350-262-20-1, dated January 1997, with Change 4, dated July 2007

TM 5-2350-262-20-2, dated January 1997, with Change 4, dated July 2007

## SECTION I PREPARATION FOR MODIFICATION

### WARNING

High pressure is present in the M9 hydraulic system. Do not disconnect any hydraulic system component unless hydraulic system pressure has been relieved. Ensure each of the hydraulic control levers is moved several times through all positions, and the hydraulic tank dipstick is slowly loosened to release pressure. After hydraulic pressure has been relieved, wait at least four (4) minutes before disconnecting any hose or fitting. Failure to comply may result in severe injury to personnel.

### CAUTION

Cap or plug all oil ports and ends of hoses and tubes when oil hoses or tubes are disconnected or removed to prevent contamination. Failure to comply may result in damage to equipment.

### CAUTION

All exposed electrical contacts and connectors should be capped, protected, or sealed to prevent damage.

### NOTE

The parts necessary to support this Chapter of MWO are used in Section I, Table 1-1, Driver's Compartment Modification Kit Parts List.

### NOTE

Drain oil and collect into suitable containers when hoses and tubes are disconnected or removed.

- a. Place vehicle over walk-in pit or elevate and place on jack stands to allow easier access to underside of vehicle for installation of modification. Block track or roadwheels.
- b. Raise and lock apron in full-up (full open) position per TM 5-2350-262-10.
- c. Remove ejector from vehicle if possible, or move ejector to front of vehicle. Refer to TM 5-2350-262-20-1, Ejector Replacement. Shut off engine.
- d. Relieve hydraulic pressure in vehicle per TM 5-2350-262-20-1.
- e. Disconnect vehicle battery power per TM 5-2350-262-20-1, Battery Cable Replacement, Negative Cables Disconnect.

## SECTION II INSTALLATION OF HDC CONTROL BOX STOWAGE FIXTURE

### NOTE

Steps a through c below apply to Figures in TM 5-2350-262-20-1 and TM 5-2350-262-20-2.

- a. Remove mounting screw at center of parking brake lever and mounting screw from lower portion of parking brake lever attached to mounting bracket per TM 5-2350-262-20-1.
- b. Move parking brake lever slightly to access self-locking screws holding driver's seat assembly in place.
- c. Remove driver's seat per TM 5-2350-262-20-2. Discard four self-locking screws.
- d. Access area behind driver's seat location.

### WARNING

Serious hearing loss and eye injury can occur during drilling and grinding operations.  
Wear ear and eye protection.

### NOTE

Apply tape over area where holes will be drilled to make it easier to mark locations and drill holes.

## SECTION II INSTALLATION OF HDC CONTROL BOX STOWAGE FIXTURE - CONTINUED

### NOTE

Steps e through h below apply to Figure 2-1.

- e. Using mounting hole location information shown in Figure 2-1, mark locations on driver's compartment rear wall to drill two holes.
- f. Drill and tap two holes on rear wall using 25/64" drill bit and 7/16" tap. Ensure all warnings are heeded during drilling.
- g. Install two inserts, MS51831-102, in holes on rear wall.
- h. Ensure floor area behind driver's seat location is clean and dry.

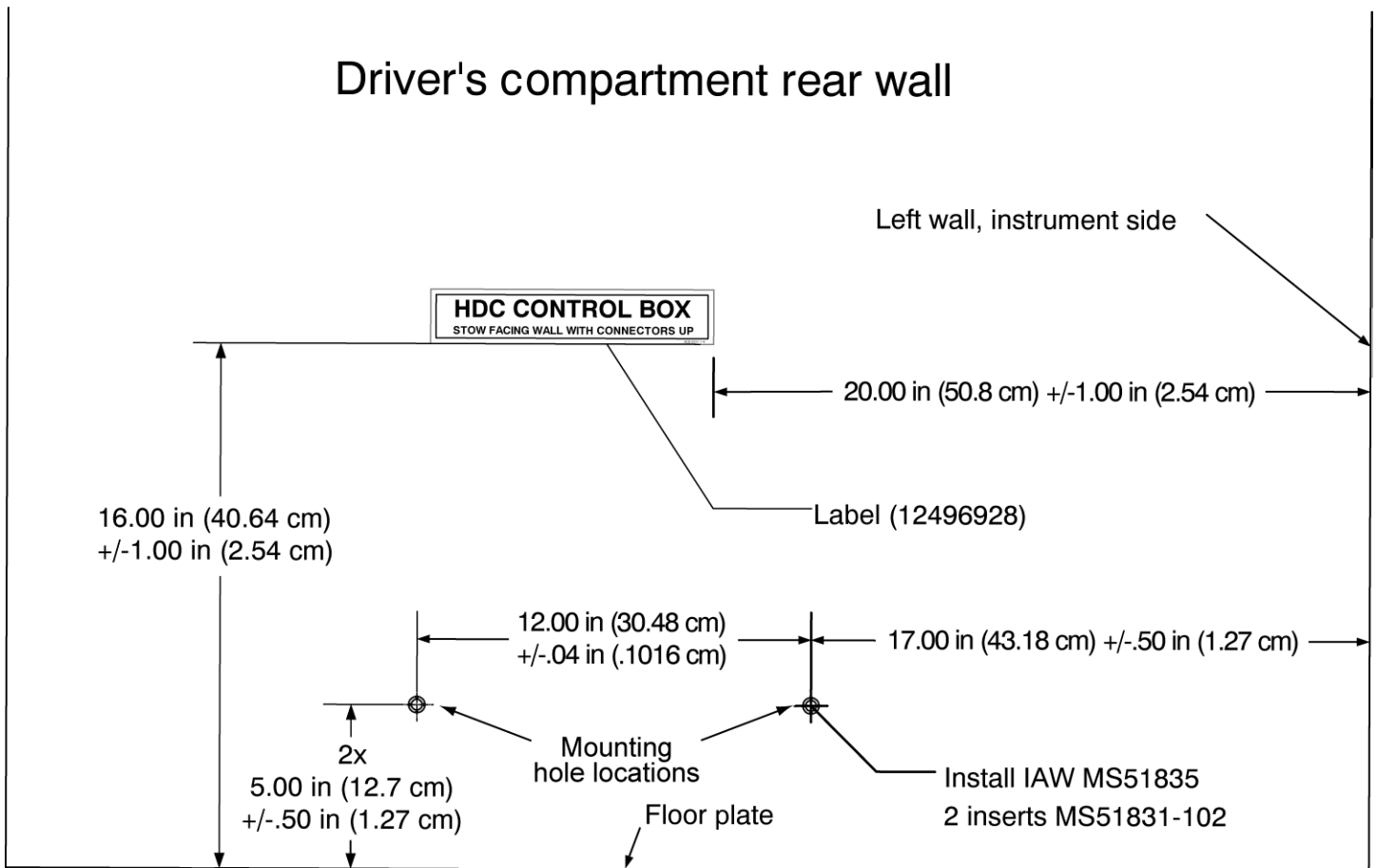

Figure 2-1. Mounting Hole Locations for Control Box Stowage Fixture

### NOTE

Clean rubber strips and use rubberized adhesive to bond rubber to painted floor.

## SECTION II INSTALLATION OF HDC CONTROL BOX STOWAGE FIXTURE - CONTINUED

### NOTE

Steps i through o below apply to Figure 2-2.

- i. Carefully install two 4-inch (10.16 cm) rubber strips, 12496932, (7) on floor near rear wall of driver's compartment between existing floor plate bolts as shown in Figure 2-2.
- j. Install two wing nuts, 10917219, (6) down over one end of two threaded rods, NAS1454C4A-0504, (4).
- k. Using a hammer or mallet, "mushroom" end of threaded rod (4), closest to wing nut (6) to ensure wing nut remains captive on rod.
- l. Place two threaded rods (4) (with captive wing nuts (6)) through holes in retainer bar, 12496933, (5) as shown on Figure 2-2.
- m. Install jam nut, MS51967-2, (3) and flat washer, MS27183-50, (2) on other end of two threaded rods (4). Thread jam nut (3) onto threaded rod end, one-half inch (12.7 mm).
- n. Install two threaded rods (4) in inserts (1) in rear wall until jam nut (3) contacts wall.
- o. Tighten jam nuts (3) to prevent threaded rods (4) from backing out of inserts (1).

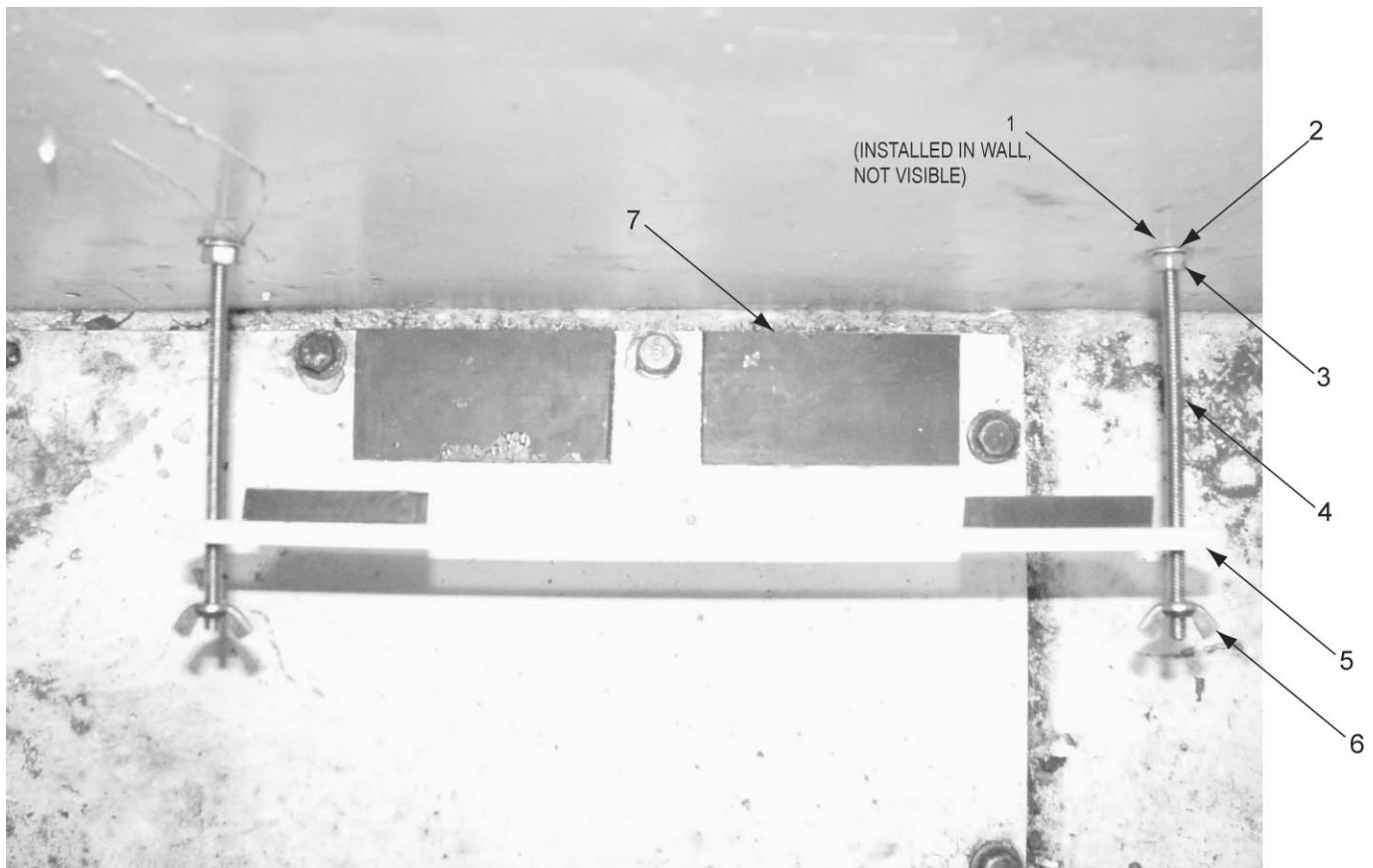

Figure 2-2. HDC Control Box Stowage Fixture Installation

## SECTION II INSTALLATION OF HDC CONTROL BOX STOWAGE FIXTURE - CONTINUED

### NOTE

Steps p through r below apply to Figure 2-3.

- p. Install self-sticking “HDC Control Box” marker, 12496928-4, (1) on rear wall above stowage location as shown in Figure 2-3.
- q. Place HDC Control Box, 12496937, (2) in stowage fixture with front of Control Box facing rearward (towards rear wall) and electrical connectors at top as shown in Figure 2-3.
- r. Hand-tighten wing nuts (4) against retainer bar (3) on threaded rods (5) to secure HDC Control Box (2) in stowed position.



Figure 2-3. HDC Control Box Stowed

## SECTION III INSTALLATION OF HDC CIRCUIT BREAKER

### NOTE

Step a below applies to Figures 2-4.

- a. Install HDC circuit breaker, AA55571/01-001, (1) on rear of umbilical cable disconnect bracket, 12496964, (5) with two screws, MS35206-249, (4), two lock washers, MS35333-38, (3), and two nuts, MS35649-282, (2) as shown in Figures 2-4. The heads of two screws (4) are accessible from front of umbilical cable disconnect bracket (5).

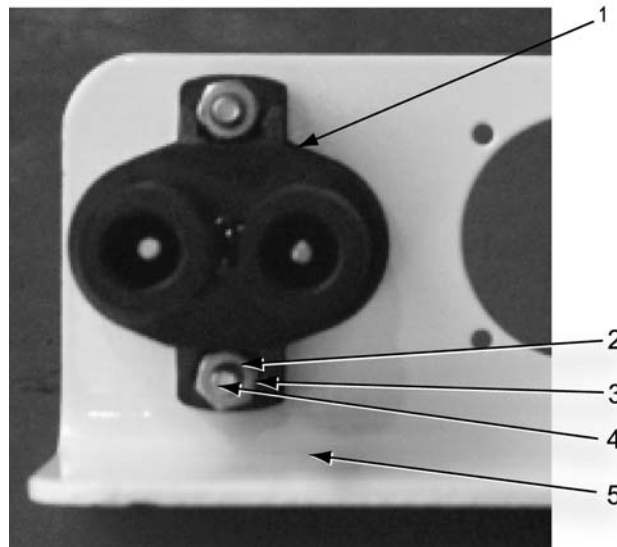

Figure 2-4. HDC Circuit Breaker Installation, Rear View

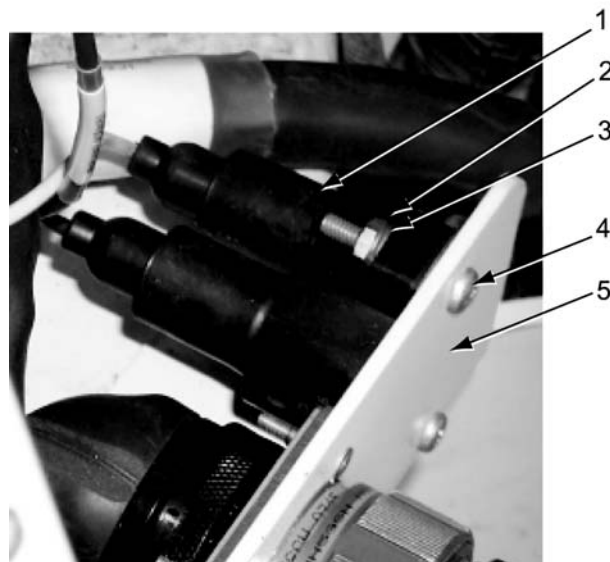

Figure 2-4. HDC Circuit Breaker Installation, Top View (Shown With Wiring and Umbilical Cable Disconnect Bracket Installed)

## SECTION IV INSTALLATION OF UMBILICAL CABLE DISCONNECT BRACKET

### WARNING

Ensure that vehicle power is off and battery disconnected. Failure to comply could result in severe injury or death.

- a. Ensure that vehicle battery power is disconnected, per TM 5-2350-262-20-1, Battery Cable Replacement, Negative Cables Disconnect.

### NOTE

Steps b and c apply to Figure 2-5.

- b. Locate suspension control levers in driver's compartment. Refer to Figure 2-5 and TM 5-2350-262-10. Figure 2-5 shows the mounting hole already drilled in the forward left bulkhead with inserts, MS51831-102, (1) installed.
- c. Remove three mounting bolts and three washers from switch panel and move switch panel slightly left, away from front of driver's compartment. Refer to TM 5-2350-262-20-1.



Figure 2-5. Driver's Compartment Area for Installation of Umbilical Cable Disconnect Bracket



## SECTION IV INSTALLATION OF UMBILICAL CABLE DISCONNECT BRACKET - CONTINUED

### WARNING

Serious hearing loss and eye injury can occur during drilling and grinding operations. Wear ear and eye protection.

### NOTE

Apply tape over area where holes will be drilled to make it easier to mark locations and drill holes.

### NOTE

Steps d through f below apply to Figure 2-6.

- d. Using right forward hole on suspension control levers mounting plate as a reference, as shown on Figure 2-6, mark locations on vehicle forward left bulkhead for drilling two holes to mount HDC umbilical cable disconnect bracket.
- e. Using a 90-degree angle head drill, drill and tap two mounting holes for HDC umbilical cable bracket using 25/64" drill bit and 7/16" tap. Ensure all warnings are heeded during drilling.
- f. Install two inserts, MS51831-102, in tapped mounting holes.

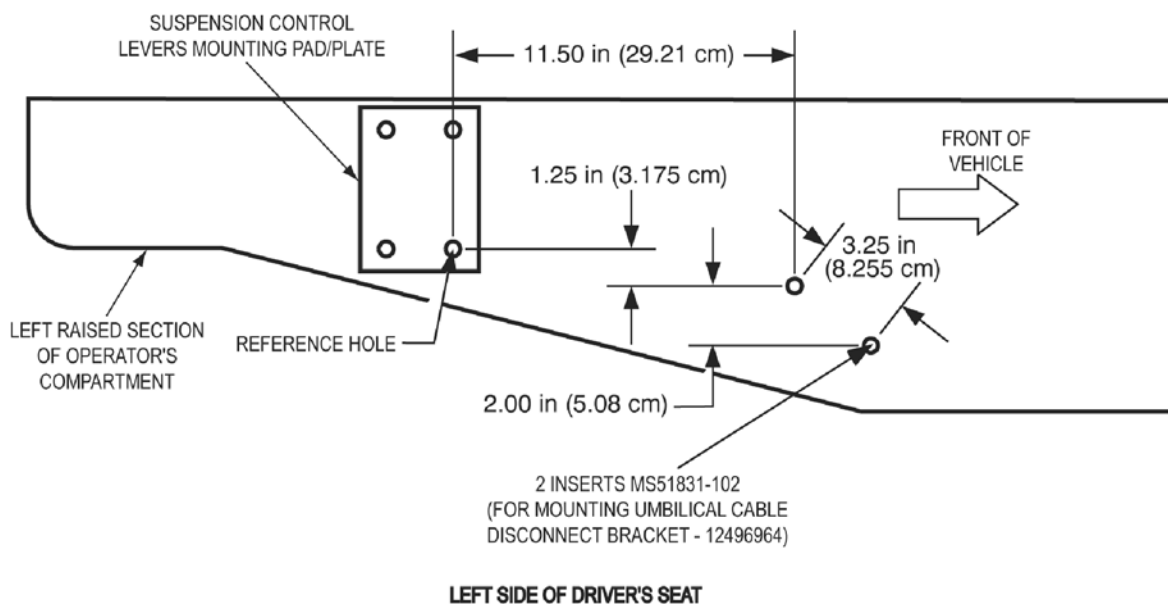

Figure 2-6. HDC Umbilical Cable Disconnect Bracket Mounting Hole Locations

## SECTION IV INSTALLATION OF UMBILICAL CABLE DISCONNECT BRACKET - CONTINUED

### NOTE

Step g below applies to Figure 2-7.

- g. Mount HDC umbilical cable disconnect bracket (1) on vehicle forward left bulkhead (vehicle sponson) (4) using two locking screws, B1821BH025C075L, (2) and two flat washers, MS27183-50, (3), as shown in Figure 2-7. Do not tighten two locking screws (2) at this time.

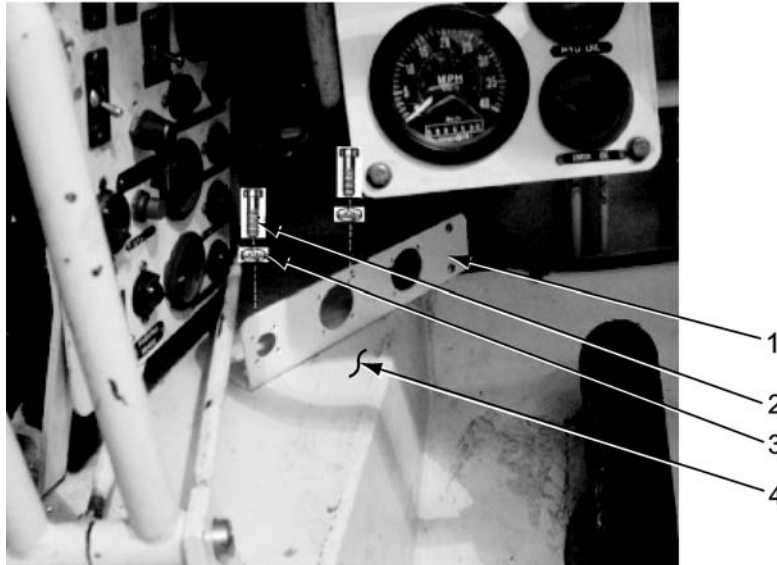

Figure 2-7. Umbilical Cable Disconnect Bracket Installation

- h. Do not reinstall switch panel (Driver's Instrument Panel) at this time.
- i. Do not reinstall driver's seat at this time.

## CHAPTER 3 MODIFICATIONS IN BOWL AREA

**SUBJECT:** Major modifications in the bowl area include the addition of a primary manifold assembly; three manually operated ball valves and other associated hydraulic system components. In addition, an existing pressure relief valve is relocated from the lower, left rear portion of the bowl area to the main filter area. There are a total of seven pressure transducers added to this area of the vehicle: two transducers in the filter area, three transducers on the new primary manifold assembly, one transducer on the pressure switch, and one transducer on the left main manifold.

**DATE:** 29 August 2008

**DESCRIPTION:** The primary manifold assembly is added in the area just beneath the directional control valve bank and requires the addition of a new set of mounting brackets to accommodate the directional control valve bank and the new primary manifold assembly.

The three manually operated ball valves provide safety features to use when personnel work in the bowl area. The ball valves, related transducers, and other additional hydraulic components are integrated into the high-pressure hydraulic filter area. The existing pressure relief valve relocated from the lower, left rear portion of the bowl area is part of the modification to the main filter area. Additionally, a pressure transducer is added to hydraulic circuits at the bottom of the bowl area.

To accommodate the installation of the primary manifold assembly, the directional control valve (DCV) bank and the existing mounting plates for the DCV bank must be removed and new mounting plates installed. The new mounting plates properly secure both the directional control valve bank and the primary manifold assembly in the bowl area. One of the new ball valves is installed near the control valve assembly and the primary manifold assembly. The other two ball valves are mounted on the high-pressure hydraulic filters. A pressure transducer is mounted on each of the high-pressure hydraulic filters above the control valve assembly in the bowl area.

Some existing parts/components are modified as part of the modification to the bowl area, and some parts are removed and discarded.

**TM REFERENCES:** The technical manual references in this procedure are for:

TM 5-2350-262-10, dated June 1992, with Change 7, dated June 2007

TM 5-2350-262-20-1, dated January 1997, with Change 4, dated July 2007

TM 5-2350-262-20-2, dated January 1997, with Change 4, dated July 2007

## SECTION I PREPARATION FOR MODIFICATION

### WARNING

High pressure is present in the M9 hydraulic system. Do not disconnect any hydraulic system component unless hydraulic system pressure has been relieved. Ensure each of the hydraulic control levers is moved several times through all positions, and the hydraulic tank dipstick is slowly loosened to relieve pressure. After hydraulic pressure has been relieved, wait at least four (4) minutes before disconnecting any hose or fitting. Failure to comply may result in severe injury to personnel.

### WARNING

Do not operate ejector when personnel are in bowl. Do not stand or work in bowl unless ejector lock is engaged. Do not stand in bowl to observe roller guide travels. Failure to comply may result in serious injury or death to personnel.

### CAUTION

All exposed electrical contacts and connectors should be capped, protected, or sealed to prevent damage.

### CAUTION

Cap or plug all oil ports and ends of hoses and tubes when oil hoses or tubes are disconnected or removed to prevent contamination. Failure to comply may result in damage to equipment.

### NOTE

Schematic diagrams for the M9 ACE vehicle hydraulic system for both the unmodified vehicle and for the HDC modified vehicle are included on FO 3-1, 1 of 3 through 3 of 3 for reference.

### NOTE

Use Teflon tape when connecting straight pipe fittings.

- a. Drain oil and collect into suitable containers when hoses and tubes are disconnected or removed.
- b. Raise and lock apron in full-up (full-open) position per TM 5-2350-262-10.
- c. Remove ejector from vehicle if possible, or move ejector to front of vehicle. Refer to TM 5-2350-262-20-1, Ejector Replacement, or TM 5-2350-262-10, as appropriate.
- d. Relieve hydraulic pressure in vehicle per TM 5-2350-262-10, Relieving Hydraulic Pressure.
- e. Disconnect vehicle battery power per TM 5-2350-262-20-1, Battery Cable Replacement, Negative Cables Disconnect.
- f. As applicable throughout these procedures, remove and discard old band markers and install new band markers as appropriate, in accordance with bowl area band marker kit, 12496929.

## **SECTION II INSTALLATION OF HDC PRIMARY MANIFOLD ASSEMBLY, MANUAL SHUT-OFF VALVE V23, AND LEFT MAIN MANIFOLD PRESSURE TRANSDUCER T7**

### **3-1 REMOVAL/DISASSEMBLY OF DCV BANK, SUSPENSION VALVE AND OTHER ITEMS TO ACCOMMODATE INSTALLATION.**

#### **WARNING**

Ensure hydraulic components are cool before performing maintenance. Failure to comply could result in personal injury or burns.

- a. Identify and tag all hydraulic hoses and tubes attached to the DCV bank control valves and the suspension (sprung/unsprung) valve. Refer to TM 5-2350-262-20-1, to identify specific DCV bank valves and hydraulic ports.

#### **WARNING**

The DCV bank weighs approximately 60 pounds. DCV bank must be fully supported when being removed from or installing on mounting brackets. Use proper lifting techniques when removing or installing DCV bank from vehicle. Failure to do so could result in serious personal injury.

#### **WARNING**

The primary manifold assembly weighs approximately 40 pounds. The assembly must be fully supported when installing. Failure to do so could result in serious personal injury.

- b. Disconnect hose from ejector cylinder and remove other end from DCV bank.
- c. Remove suspension (sprung/unsprung) valve from mounting brackets (as described in step o.) before removing the DCV bank, to facilitate removal of the DCV bank.

## SECTION II INSTALLATION OF HDC PRIMARY MANIFOLD ASSEMBLY, MANUAL SHUT-OFF VALVE V23, AND LEFT MAIN MANIFOLD PRESSURE TRANSDUCER T7 - CONTINUED

### 3-1 REMOVAL/DISASSEMBLY OF DCV BANK, SUSPENSION VALVE AND OTHER ITEMS TO ACCOMMODATE INSTALLATION - CONTINUED

- d. Remove split pipe flange, attached hydraulic hose and second hydraulic hose from the back of the DCV bank before removing the DCV bank from the bowl and mounting brackets.
- e. Remove six cotter pins and disconnect mechanical control linkages from DCV bank valves per TM 5-2350-262-20-2, Directional Control Valve Bank Replacement. Discard six cotter pins.
- f. Detach, but do not disassemble, DCV bank from mounting brackets per TM 5-2350-262-20-2, Directional Control Valve Bank Replacement. Discard locknuts, but save four mounting screws and flat washers for reuse.

#### NOTE

Steps g through i below apply to Figure 3-1.

- g. Remove four locking screws (1) and four flat washers (5) attaching split pipe flange (2) to back of DCV bank (3). Discard locking screws but save flat washers.
- h. Disconnect hydraulic hose (4) from same area on back of DCV bank (3). DCV bank is now free to be moved.
- i. Move DCV bank (3) from bowl area and place on flat, level surface capable of supporting sixty pounds.

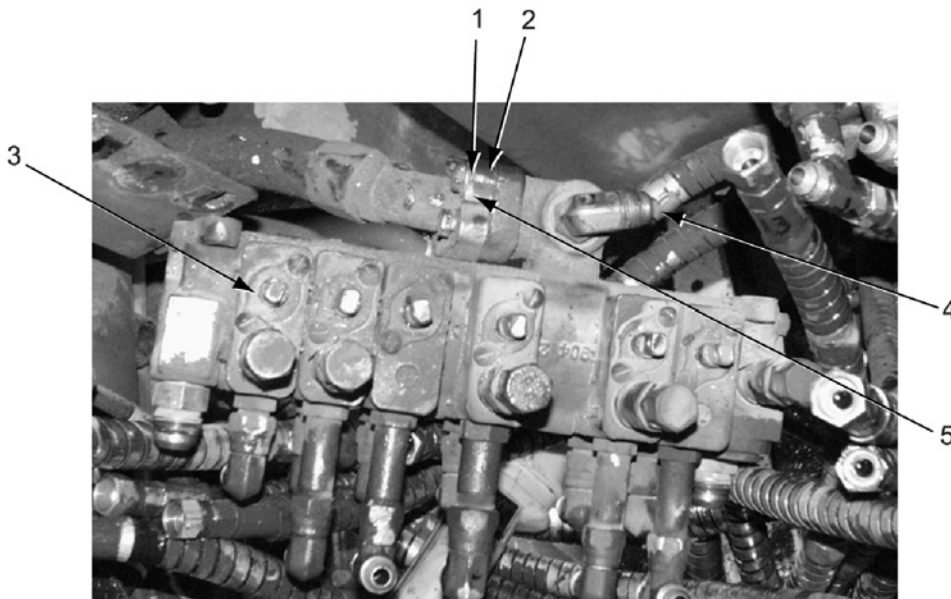

Figure 3-1. Components to be Removed from DCV Bank - Split Flange Assembly

## SECTION II INSTALLATION OF HDC PRIMARY MANIFOLD ASSEMBLY, MANUAL SHUT-OFF VALVE V23, AND LEFT MAIN MANIFOLD PRESSURE TRANSDUCER T7 - CONTINUED

### 3-1 REMOVAL/DISASSEMBLY OF DCV BANK, SUSPENSION VALVE AND OTHER ITEMS TO ACCOMMODATE INSTALLATION - CONTINUED

#### NOTE

Steps j through m below apply to Figure 3-2.

- j. Remove and save elbow, MS51521A10, (7) from adapter, MS515A26A10, (6) installed on DCV bank ejector forward port 21 (8).
- k. Remove and discard adapter, MS51526A10, (6) and o-ring, MS28778-10, (1) from DCV bank ejector forward port 21.
- l. Remove and discard elbow, MS51521A8, (5) from DCV bank ejector retract port 22 (9).
- m. Remove and discard elbow, MS51521A8, (4) adapter, AC-1-310, (3) and o-ring, MS28778-8, (2) from DCV bank winch pay-out port C1 (10).

#### NOTE

If difficulty is encountered in removing hydraulic hoses from suspension (sprung/unsprung) valve when removing valve from bracket, remove mounting bracket from bowl with valve and hoses still installed. Remove valve (with hoses attached) from bracket after bracket is removed (in step q) from bowl.

- n. Remove cotter pin and disconnect mechanical control linkage from suspension valve per TM 5-2350-262-20-2, Hydraulic Control Levers, Bellcranks, and Linkage Replacement and Repair. Discard cotter pin.
- o. Remove, but don't disassemble, suspension (sprung/unsprung) valve from mounting bracket per TM 5-2350-262-20-2, Sprung/Unsprung Valve Replacement. Discard locknuts but save four mounting screws and flat washers for reuse.

**SECTION II INSTALLATION OF HDC PRIMARY MANIFOLD ASSEMBLY,  
MANUAL SHUT-OFF VALVE V23, AND LEFT MAIN MANIFOLD PRESSURE  
TRANSDUCER T7 - CONTINUED**

**3-1 REMOVAL/DISASSEMBLY OF DCV BANK, SUSPENSION VALVE AND OTHER  
ITEMS TO ACCOMMODATE INSTALLATION - CONTINUED**

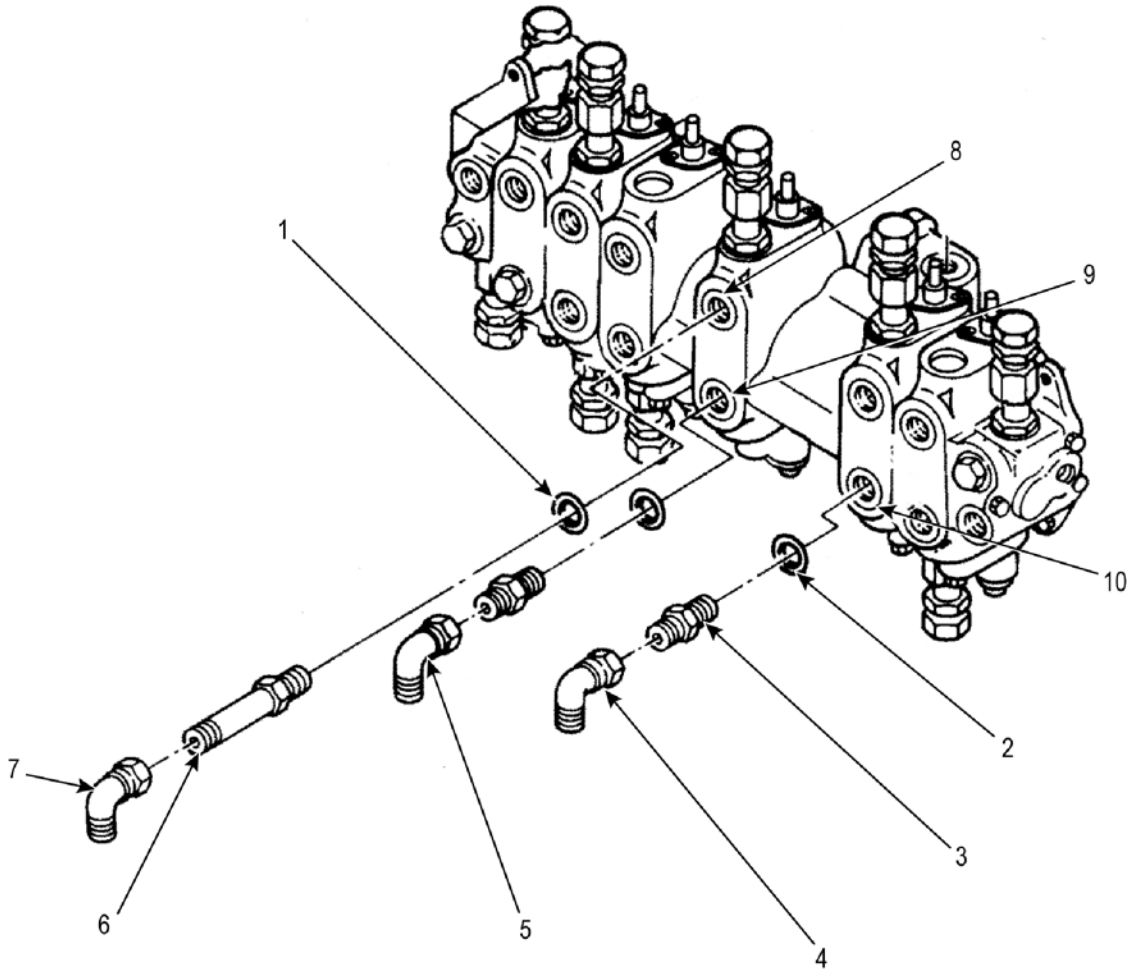

**Figure 3-2. Components to be Removed and/or Replaced on DCV Bank**



## SECTION II INSTALLATION OF HDC PRIMARY MANIFOLD ASSEMBLY, MANUAL SHUT-OFF VALVE V23, AND LEFT MAIN MANIFOLD PRESSURE TRANSDUCER T7 - CONTINUED

### 3-1 REMOVAL/DISASSEMBLY OF DCV BANK, SUSPENSION VALVE AND OTHER ITEMS TO ACCOMMODATE INSTALLATION - CONTINUED

#### NOTE

Step p below applies to Figure 3-3.

#### NOTE

Clamp assembly is shown disassembled in Figure 3-3 with only the lower portion of the clamp assembly attached to the bracket. Figure 3-3 shows the lower portion of the clamp assembly attached to the new inboard angle bracket that will be installed, and not the existing inboard mounting bracket that is removed and discarded in step q.

- p. Remove clamp assembly (1) from inboard valve bracket (2). Retain two bolts (4) and two flat washers (3). It is recommended that clamp assembly not be disassembled but remain intact with three hoses clamped in place. It is not necessary to disassemble clamp assembly to perform this modification.

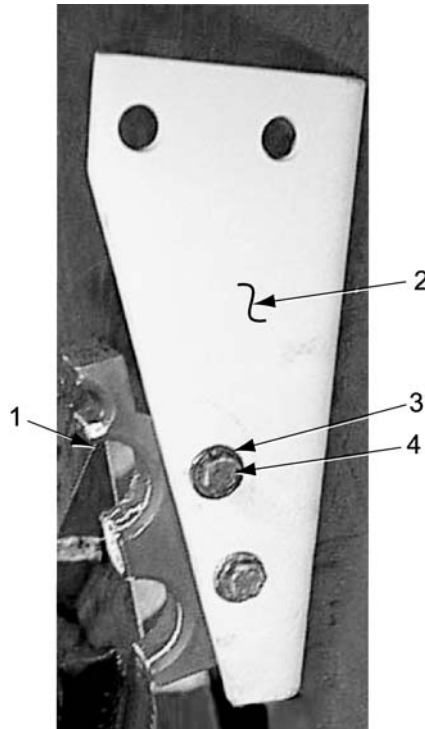

Figure 3-3. Components to be Replaced - Clamp Assembly

## SECTION II INSTALLATION OF HDC PRIMARY MANIFOLD ASSEMBLY, MANUAL SHUT-OFF VALVE V23, AND LEFT MAIN MANIFOLD PRESSURE TRANSDUCER T7 - CONTINUED

### 3-1 REMOVAL/DISASSEMBLY OF DCV BANK, SUSPENSION VALVE AND OTHER ITEMS TO ACCOMMODATE INSTALLATION - CONTINUED

#### NOTE

Step q applies to Figure 3-4.

- q. Remove and discard inboard, 13211E9561, (1), and outboard, 13211E9562, (6) mounting brackets from vehicle bulkheads. Discard locking screws (3) but save flat washers (2) for reuse.

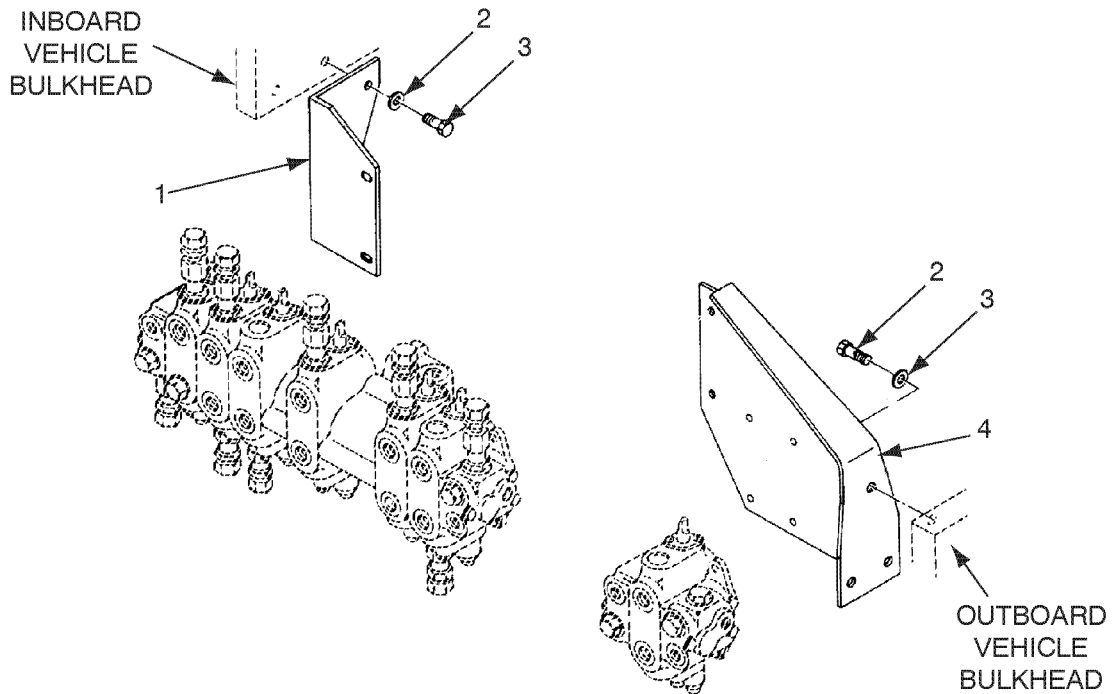

Figure 3-4. Components to be Removed and/or Replaced - DCV Bank and Suspension Valve Mounting Brackets

## SECTION II INSTALLATION OF HDC PRIMARY MANIFOLD ASSEMBLY, MANUAL SHUT-OFF VALVE V23, AND LEFT MAIN MANIFOLD PRESSURE TRANSDUCER T7 - CONTINUED

### 3-1 REMOVAL/DISASSEMBLY OF DCV BANK, SUSPENSION VALVE AND OTHER ITEMS TO ACCOMMODATE INSTALLATION - CONTINUED

#### NOTE

Steps r and s apply to Figure 3-5.

- r. Remove and discard large angle bracket, 13214E2764, (4) attached to hull floor by removing locking screw (3) and flat washer, MS27183-18, (2).
- s. Note location of pressure relief valve (1) relative to left main manifold. The pressure relief valve will be relocated to pump filter area later in this chapter.

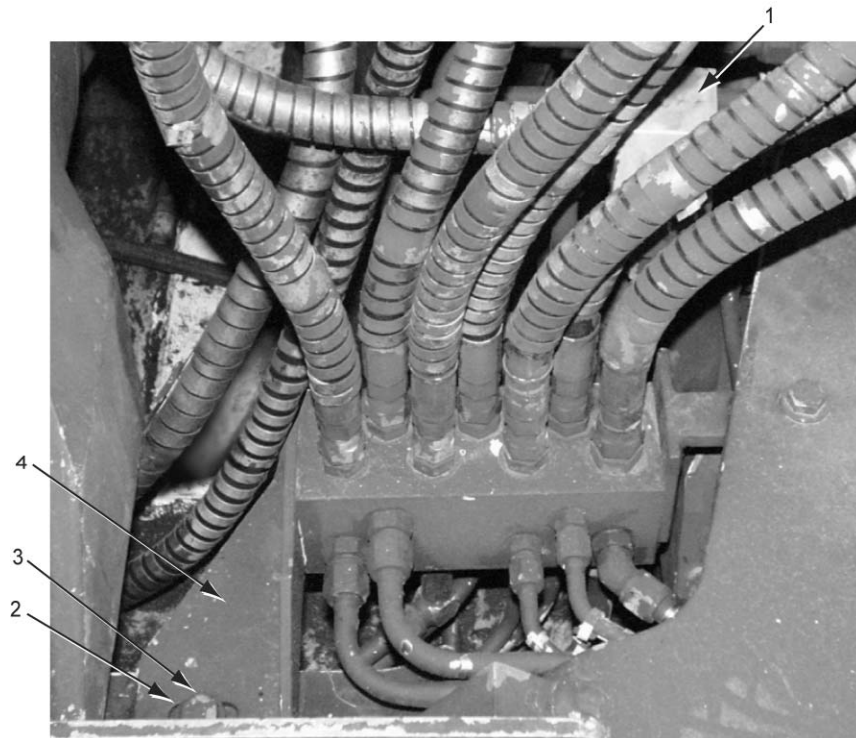

Figure 3-5. Components to be Removed in Lower Bowl Area Near Left Main Manifold

## **SECTION II INSTALLATION OF HDC PRIMARY MANIFOLD ASSEMBLY, MANUAL SHUT-OFF VALVE V23, AND LEFT MAIN MANIFOLD PRESSURE TRANSDUCER T7 - CONTINUED**

### **3-2 ASSEMBLY OF HDC PRIMARY MANIFOLD**

#### **CAUTION**

Assembly should be performed in a clean environment and protective dust covers or caps should be installed on all openings to prevent contamination. Dirt can damage parts and cause malfunctions.

#### **CAUTION**

When securing primary manifold in vice grip, exercise extreme care not to mar any surfaces or damage components.

#### **CAUTION**

Do not over torque. Failure to comply may result in damage to equipment.

#### **NOTE**

A vice must be used to secure the primary manifold during assembly.

#### **NOTE**

Refer to Section I, Table 1-3, Primary Manifold Parts List for required parts.

#### **NOTE**

Steps a through d apply to Figure 3-6.

## SECTION II INSTALLATION OF HDC PRIMARY MANIFOLD ASSEMBLY, MANUAL SHUT-OFF VALVE V23, AND LEFT MAIN MANIFOLD PRESSURE TRANSDUCER T7 - CONTINUED

### 3-2 ASSEMBLY OF HDC PRIMARY MANIFOLD - CONTINUED

- a. Install new o-ring, MS28778-10, (2) and 45° adapter, MS51528A10, (1) on primary manifold (12). Torque 45° adapter (1) to 43-48 ft/lbs (58.30-65.07 N•m).
- b. Install eleven new o-rings, MS28778-8, (4), five straight adapters, AC-1-310, (5), 45° adapter, MS51528A8, (8), 90° adapter, MS51527A-8, (11), and four plugs, 12335054-5, (3) on primary manifold (12). Torque adapters and plugs to 40-43 ft/lbs (54.23-58.30 N•m).
- c. Install two new o-rings, MS28778-4, (7) and two plugs, 12335054-2, (6) on primary manifold (12). Torque plugs to 13-15 ft/lbs (17.62-20.33 N•m).
- d. Install new o-ring, MS28778-6, (10) and plug, 12335054-4, (9) on primary manifold (12). Torque plugs to 22-24 ft/lbs (29.82-32.53 N•m).

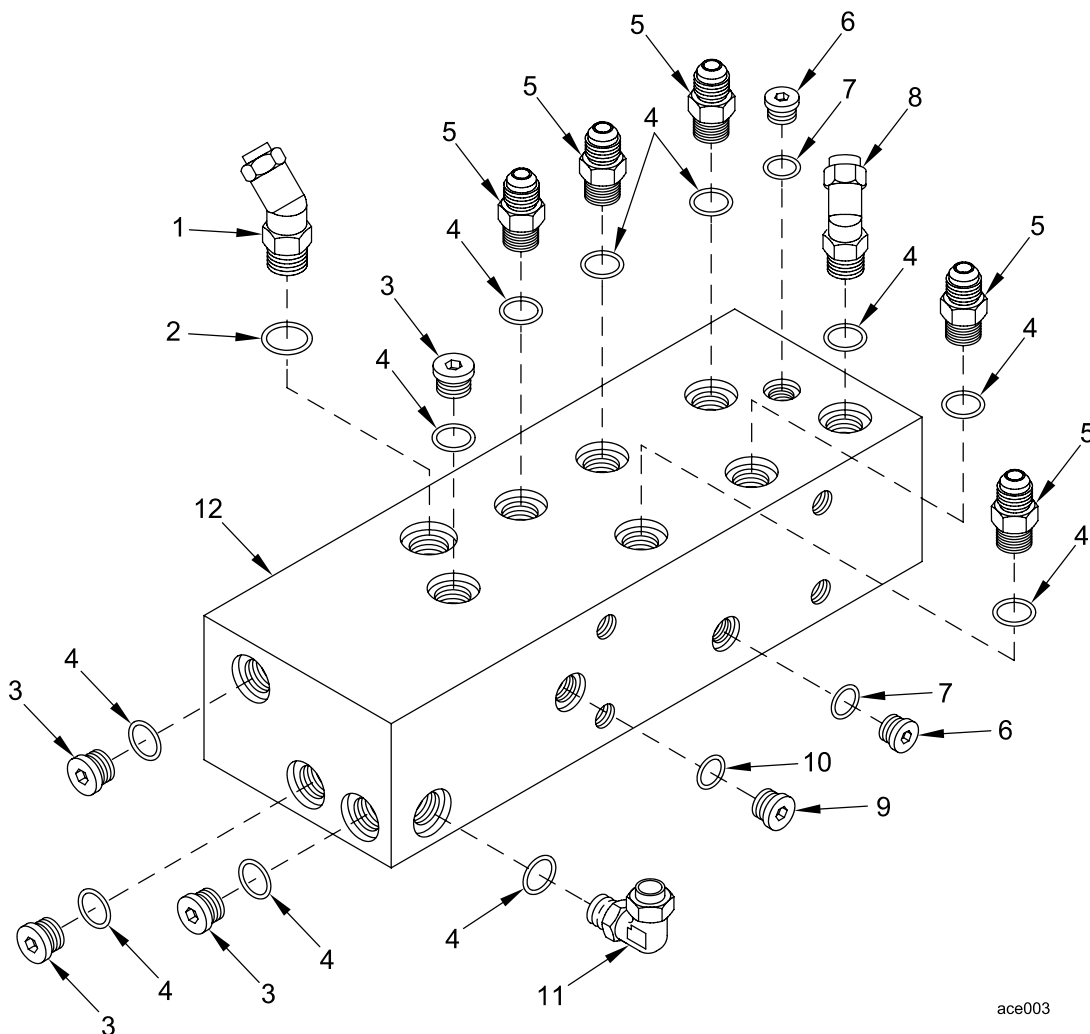

ace003

Figure 3-6. Primary Manifold Assembly, Bottom, Rear and End View

## SECTION II INSTALLATION OF HDC PRIMARY MANIFOLD ASSEMBLY, MANUAL SHUT-OFF VALVE V23, AND LEFT MAIN MANIFOLD PRESSURE TRANSDUCER T7 - CONTINUED

### 3-2 ASSEMBLY OF HDC PRIMARY MANIFOLD - CONTINUED

#### NOTE

Steps e through j apply to Figure 3-7.

- e. Install three new o-rings, MS28778-4, (4) and three plugs, 12335054-2, (5) on primary manifold (3). Torque plugs to 13-15 ft/lbs (17.62-20.33 N•m).
- f. Install ten new o-rings, MS28778-8, (7), two plugs, 12335054-5, (6), six straight adapters, AC-1-310, (8), and two 90° adapters, MS51527A-8, (11) on primary manifold (3). Torque plugs and adapters to 40-43 ft/lbs (54.23-58.30 N•m).
- g. Install new o-ring, MS28778-10, (9) and straight adapter, MS51526A-10, (10) on primary manifold (3). Torque adapter to 43-48 ft/lbs (58.30-65.07 N•m).
- h. Install relief valve, 1A30-F-60SV, (12) on primary manifold (3). Torque valve seating nut to 40-50 ft/lbs (54.23-67.79 N•m) and valve cap and lock nut to 10-15 ft/lbs (13.55-20.33 N•m).
- i. Install o-ring, MS28775-118, (13), teflon backup, MS27595-019, (14), o-ring, MS28775-019, (15), and teflon backup, MS27595-019, (14), normally closed valve, 12496926, (16) on primary manifold, (3). Install two o-rings, MS28778-4, (17) and two pressure transducers, 12496923, (18) on primary manifold, (3). Torque valve cartridge to 40-44 ft/lbs (54.23-59.65 N•m), valve coil to 28-34 ft/lbs (37.96-46.09 N•m), transducer cartridges to 13-15 ft/lbs (17.62-20.33 N•m).
- j. Install on two 3-way valves, 12496936, (19), o-ring, MS28778-12, (20), teflon backup, MS28774-019, (21), o-ring, MS28775-019, (22), teflon backup, MS28774-019, (21), teflon backup MS28774-018, (23), o-ring, MS28775-018, (24), and teflon backup MS28774-018, (23), on primary manifold (3).

**SECTION II INSTALLATION OF HDC PRIMARY MANIFOLD ASSEMBLY,  
MANUAL SHUT-OFF VALVE V23, AND LEFT MAIN MANIFOLD PRESSURE  
TRANSDUCER T7 - CONTINUED**

**3-2 ASSEMBLY OF HDC PRIMARY MANIFOLD - CONTINUED**

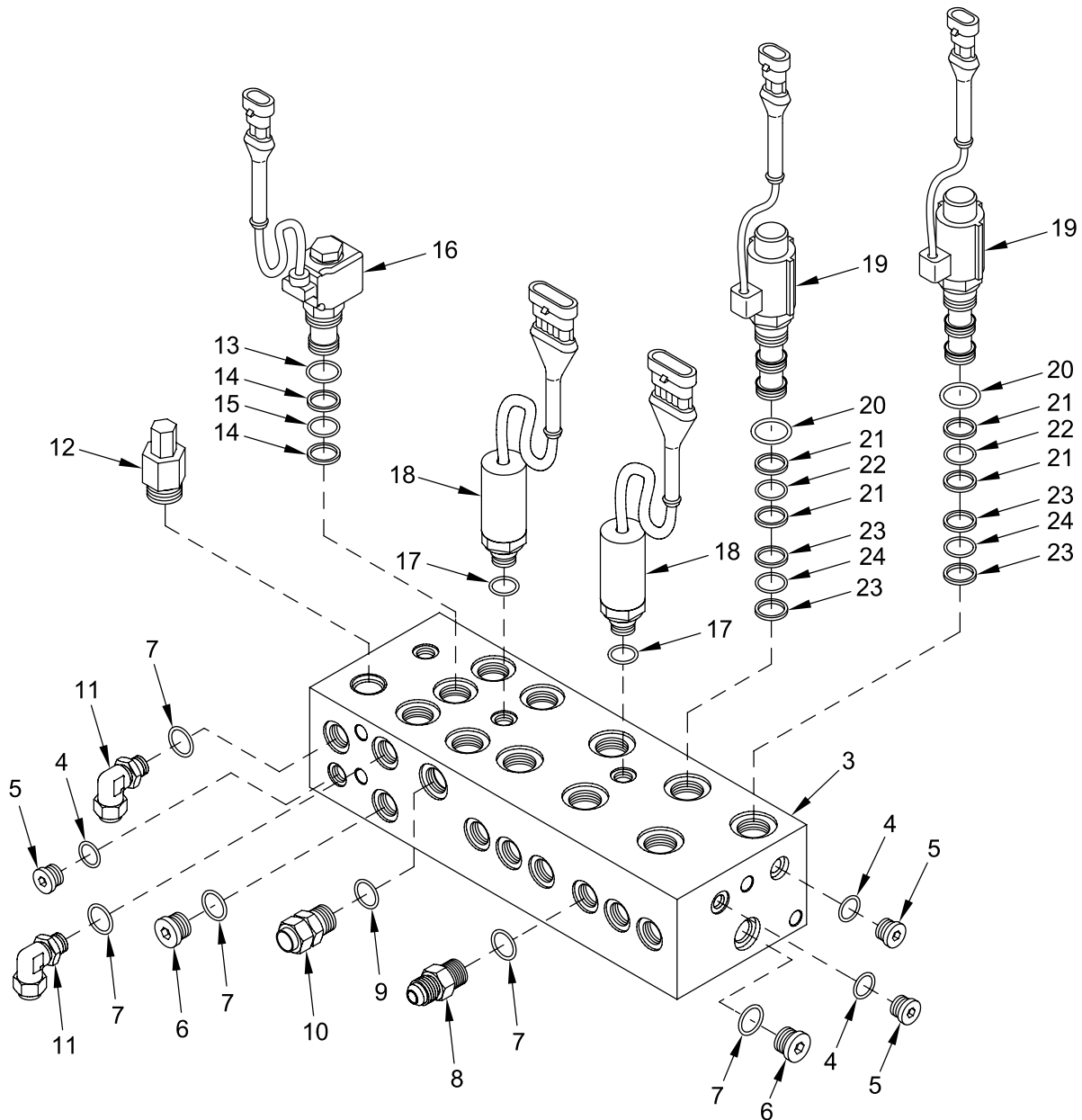

**Figure 3-7. Primary Manifold Assembly, Top, Front and End View**

## SECTION II INSTALLATION OF HDC PRIMARY MANIFOLD ASSEMBLY, MANUAL SHUT-OFF VALVE V23, AND LEFT MAIN MANIFOLD PRESSURE TRANSDUCER T7 - CONTINUED

### 3-2 ASSEMBLY OF HDC PRIMARY MANIFOLD - CONTINUED

#### NOTE

Steps k and l apply to Figure 3-8.

- k. Install on three normally open valves, 12496925, (1) and one normally closed valve, 12496926, (5); o-ring, MS28775-118, (2), one teflon backup, MS27595-019, (3), one o-ring, MS28775-019, (4), and one teflon backup, MS27595-019, (3) on primary manifold (14). Install o-ring, MS28778-4, (7) and transducer, 12496923, (6) on primary manifold (14). Torque valve cartridges to 40-44 ft/lbs (54.23-59.65 N•m), valve coils to 28-34 ft/lbs (37.96-46.09 N•m), and transducer cartridge to 13-15 ft/lbs (17.62-20.33 N•m).
- l. Install on four 3-way valves, 12496936, (8); one o-ring, MS28778-12, (9), one backup, MS28774-019, (10), one o-ring, MS28775-019, (11), one backup, MS28774-019, (10), one backup, MS28774-018, (12), one o-ring, MS28775-018, (13), and one backup, MS28774-018, (12) on primary manifold (14). Torque valve cartridges to 40-44 ft/lbs (54.23-59.65 N•m) and valve coils to 28-34 ft/lbs (37.96-46.09 N•m).

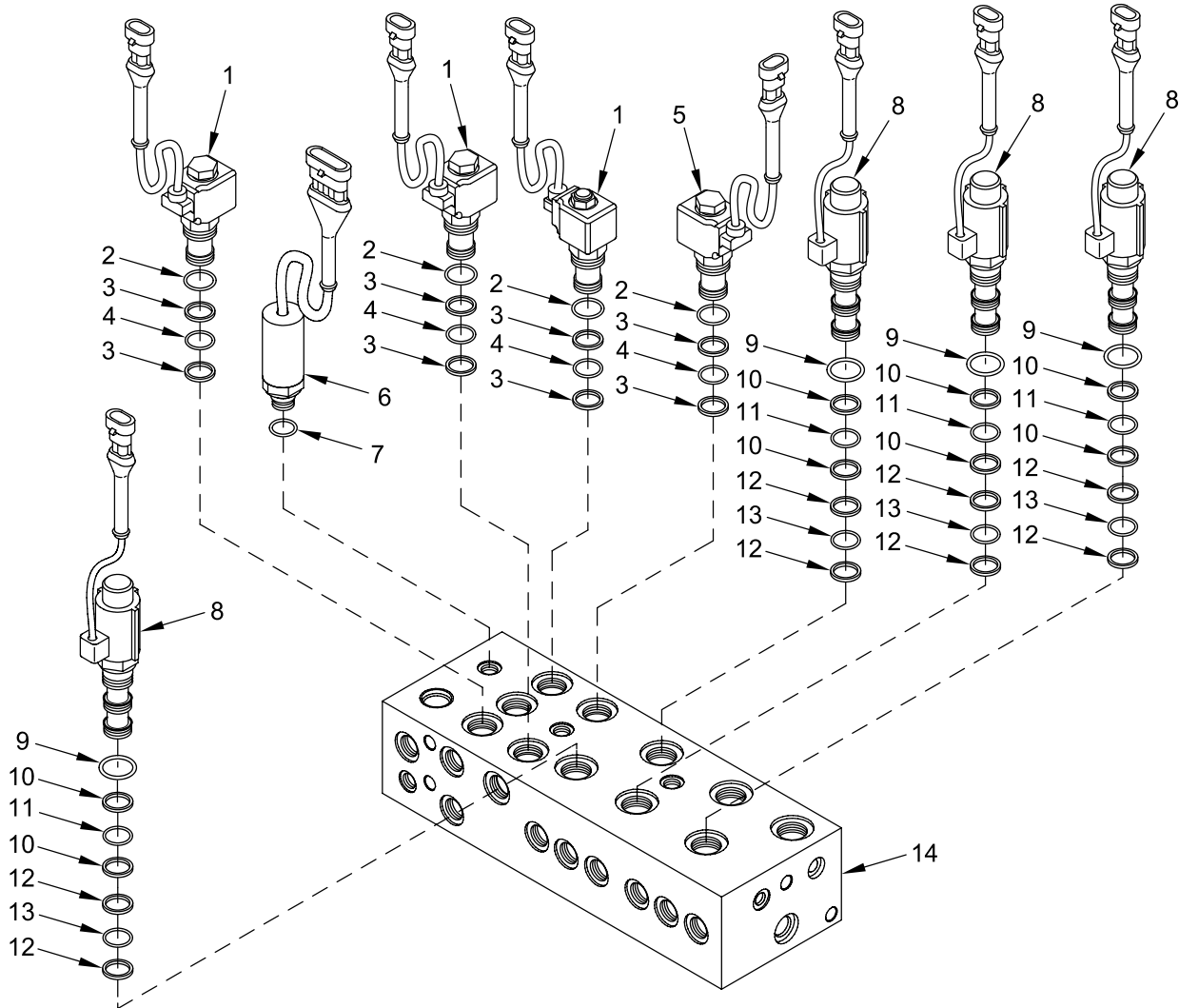

**Figure 3-8. Primary Manifold Assembly, Top View**



## SECTION II INSTALLATION OF HDC PRIMARY MANIFOLD ASSEMBLY, MANUAL SHUT-OFF VALVE V23, AND LEFT MAIN MANIFOLD PRESSURE TRANSDUCER T7 - CONTINUED

### 3-3 PRIMARY MANIFOLD FUNCTIONALITY TESTING

#### CAUTION

Testing should be performed in a clean environment and protective dust covers or caps should be installed on all openings to prevent contamination. Dirt can damage parts and cause malfunctions.

#### NOTE

Prior to installing the primary manifold in a vehicle, the following functionality tests should be performed.

#### NOTE

Steps a through c apply to Figure 3-9.

- a. Testing hydraulic circuit port 17R to port 17R through Valve V5.
  1. Connect a -8 hydraulic pressure hose to port 17R (front of manifold).
  2. Connect a multimeter(s) adjusted to read 15 VDC full scale to pressure transducers T1, T2 and T13.
  3. Connect a 28 VDC power supply with the output adjusted to 28 VDC to valve V5. Ensure the DC power supply is turned off at this time.

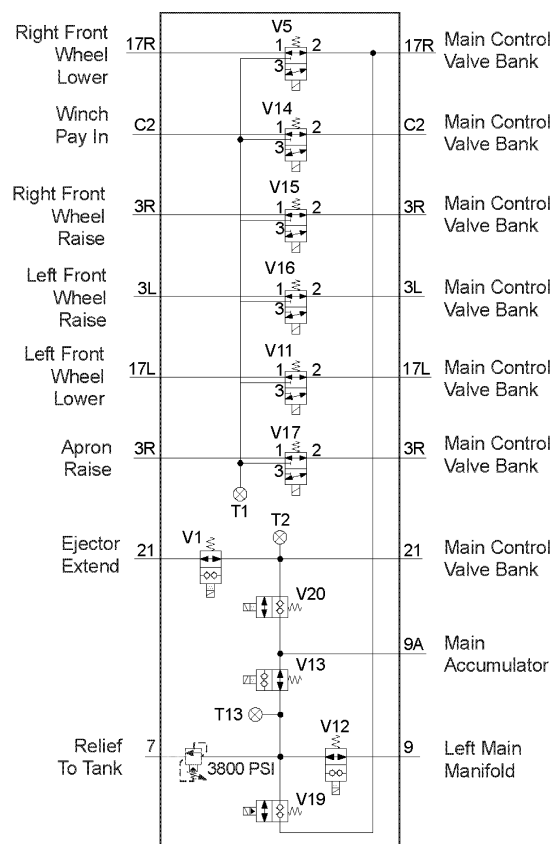
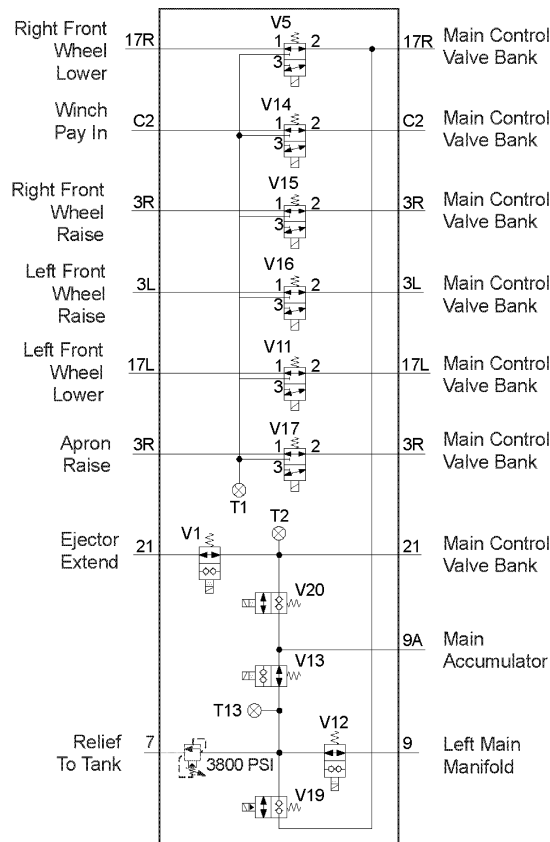

Figure 3-9. Primary Manifold Assembly Hydraulic Schematic Diagram

## SECTION II INSTALLATION OF HDC PRIMARY MANIFOLD ASSEMBLY, MANUAL SHUT-OFF VALVE V23, AND LEFT MAIN MANIFOLD PRESSURE TRANSDUCER T7 - CONTINUED

### 3-3 PRIMARY MANIFOLD FUNCTIONALITY TESTING - CONTINUED

4. Connect a -8 return hose to port 17R (bottom of manifold).
5. Apply hydraulic pressure of 3000 psig (20684.27 kilopascal) @ 10 GPM (37854.12 CPM) to the -8 hose port 17R (front of manifold). Hydraulic fluid should be flowing at 3000 psig (20684.27 kilopascal) @10 GPM (37854.12 CPM) from port 17R (bottom of manifold).
6. View the other manifold ports to determine if fluid is exiting any ports. If fluid is exiting those ports, document which ports and stop the test.
7. Turn on the 24 VDC power supply. Valve V5 should activate and no fluid should be flowing from port 17R (bottom of manifold). The multimeter connected to pressure transducer T1 should read voltage equivalent to 7.125 VDC (3000 psig) (20684.27 kilopascal).
8. Turn off the 24 VDC power supply and view the multimeter connected to pressure transducer T1 to ensure the voltage rapidly decreases at T1. Hydraulic fluid should be flowing at 3000 psig (20684.27 kilopascal) @10 GPM (37854.12 CPM) from port 17R (bottom of manifold).
9. Remove the hydraulic input pressure from the -8 hose connected to port 17R (front of manifold).
10. Remove the -8 hydraulic return hose from port 17R (bottom of manifold)
11. Install a -8, 37° flare nut cap onto port 17R (bottom of manifold).
12. Disconnect 28 VDC power supply from V5.



**Figure 3-9. Primary Manifold Assembly Hydraulic Schematic Diagram**

## SECTION II INSTALLATION OF HDC PRIMARY MANIFOLD ASSEMBLY, MANUAL SHUT-OFF VALVE V23, AND LEFT MAIN MANIFOLD PRESSURE TRANSDUCER T7 - CONTINUED

### 3-3 PRIMARY MANIFOLD FUNCTIONALITY TESTING - CONTINUED

- b. Testing hydraulic circuit port 17R to ports 7, 9, 9A and both port 21s.
  1. Connect a 28 VDC power supply with the output adjusted to 28 VDC to valve(s) V1, V12, V13, V19 and V20. Ensure the power supply is turned off at this time.
  2. Install -10, 37° flare nut caps at port 21 (front and bottom). Also install -8, 37° flare nut caps at ports 9 (front of manifold) and 9A (rear of manifold).
  3. Apply hydraulic pressure of 3000 psig (20684.27 kilopascal) @ 10 GPM (37854.12 CPM) to the -8 hose port 17R (front of manifold).
  4. View the other manifold ports to determine if fluid is exiting any ports. If fluid is exiting those ports, document which ports and stop the testing.
  5. View the outputs of pressure transducers T1, T2 and T13. What are the voltages, if any? Record the voltage readings.
  6. Turn the valve V19 power supply on and read the voltage at pressure transducer T13 and T2. Record the voltages.
  7. Turn the valve V20 power supply on and read the voltage at pressure transducer T13 and T2. Record the voltages.
  8. Turn off the valve V19 and V20 power supplies.
  9. Remove the hydraulic input pressure from the -8 hose connected to port 17R (front of manifold). Loosen the -8, 37° flare nut cap on port 17R (bottom of manifold) to remove residual pressure. Re-tighten the -8, 37° flare nut cap when pressure and flow have stopped.
  10. Remove the -8, 37° flare nut cap on port 9A.
  11. Apply hydraulic pressure of 3000 psig (20684.27 kilopascal) @ 10 GPM (37854.12 CPM) to the -8 hose port 17R (front of manifold).
  12. View the other manifold ports to determine if fluid is exiting any ports. If fluid is exiting those ports, document which ports.
  13. Remove all 28 VDC connectors from the manifold valves.
  14. Turn the valve V19 power supply on and read the voltage at pressure transducer T13 and T2. Record the voltages. Pressurized fluid should flow from port 9A.
  15. Turn the valve V13 power supply on and read the T13 pressure transducer voltage. Record the voltage reading. Pressurized fluid from port 9A should stop.
  16. Turn off the valve V13 power supply. Fluid from port 9A should continue.
  17. Turn off the valve V19 power supply.
  18. Remove the hydraulic input pressure from the -8 hose connected to port 17R (front of manifold). There should not be any hydraulic pressure in the manifold.
  19. Install -8, 37° flare nut cap on port 9A.
  20. Remove the -8, 37° flare nut cap on port 9.
  21. Connect a 28VDC power supply to Valve V12 and valve V19.
  22. Apply hydraulic pressure of 3000 psig (20684.27 kilopascal) @ 10 GPM (37854.12 CPM) to the -8 hose port 17R (front of manifold).

## SECTION II INSTALLATION OF HDC PRIMARY MANIFOLD ASSEMBLY, MANUAL SHUT-OFF VALVE V23, AND LEFT MAIN MANIFOLD PRESSURE TRANSDUCER T7 - CONTINUED

### 3-3 PRIMARY MANIFOLD FUNCTIONALITY TESTING - CONTINUED

23. Turn the power supply on and fluid should not flow from port 9. Record the voltage from T13 pressure transducer.
24. View the other manifold ports to determine if fluid is exiting any ports. If fluid is exiting those ports, document which ports and stop the testing.
25. Turn the power supply off and remove the hydraulic input pressure from the -8 hose connected to port 17R (front of manifold). There should not be any hydraulic pressure applied to the manifold.
26. Install -8, 37° flare nut cap on port 9.
27. Remove the -8, 37° flare nut cap on port 7.
28. Connect a 28 VDC power supply to valve V19.
29. Apply hydraulic pressure of 3000 psig (20684.27 kilopascal) @ 10 GPM (37854.12 CPM) to the -8 hose port 17R (front of manifold).
30. Turn the power supply on for valve V19.
31. Slowly increase the hydraulic pressure until fluid is coming from port 7. Record the pressure relief valve setting is 3800 psi.

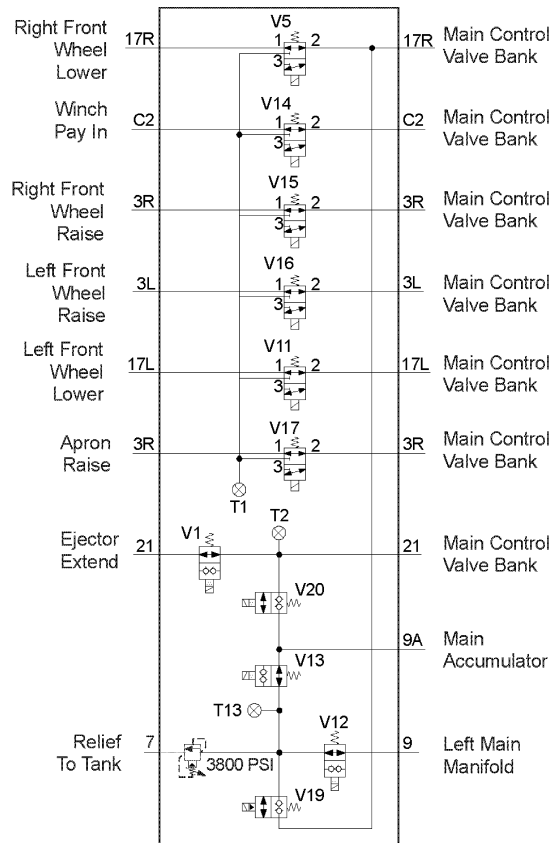

**Figure 3-9. Primary Manifold Assembly Hydraulic Schematic Diagram**

## SECTION II INSTALLATION OF HDC PRIMARY MANIFOLD ASSEMBLY, MANUAL SHUT-OFF VALVE V23, AND LEFT MAIN MANIFOLD PRESSURE TRANSDUCER T7 - CONTINUED

### 3-3 PRIMARY MANIFOLD FUNCTIONALITY TESTING - CONTINUED

32. Turn the power supply off and remove the hydraulic input pressure from the -8 hose connected to port 17R (front of manifold). There should not be any hydraulic pressure applied to the manifold.
33. Install a -8, 37° flare nut cap on port 7.
34. Connect a power supply to valve V19 and V20.
35. Remove the -10, 37° flare nut cap on port 21 (bottom of manifold).
36. Apply hydraulic pressure of 3000 psig (20684.27 kilopascal) @ 10 GPM (37854.12 CPM) to the -8 hose port 17R (front of manifold).
37. Energize the power supply to valves V19 and V20. Fluid should be flowing from port 21 (bottom of manifold).
38. Record the voltage reading for pressure transducers T13 and T2.
39. Turn the power supply off and remove the hydraulic input pressure from the -8 hose connected to port 17R (front of manifold). There should not be any hydraulic pressure applied to the manifold.
40. Install the -8, 37° flare nut cap on port 21 (bottom of manifold).
41. Apply hydraulic pressure of 3000 psig (20684.27 kilopascal) @ 10 GPM (37854.12 CPM) to the -8 hose port 17R (front of manifold).
42. Energize the power supply to valves V19 and V20.
43. Record the voltage reading for pressure transducers T13 and T2.
44. Turn the power supply off and remove the hydraulic input pressure from the -8 hose connected to port 17R (front of manifold). There should not be any hydraulic pressure applied to the manifold.
45. Remove the -10, 37° flare nut cap on port 21 (side of manifold).
46. Connect a 28 VDC power supply to valves V19, V20 and V1.
47. Apply hydraulic pressure of 3000 psig (20684.27 kilopascal) @ 10 GPM (37854.12 CPM) to the -8 hose port 17R (front of manifold).
48. Energize the 28 VDC power supply to valves V19, V20 and V1.
49. Fluid should flow not flow from port 21 (side of manifold).
50. Read and record the voltage at pressure transducers T2 and T13.
51. De-energize the 28 VDC power supply and remove the valve V1 connection from the power supply. Continue the valve V19 and V20 connection to the power supply.
52. Energize the power supply and observe fluid flowing from port 21 (side of manifold).
53. Turn the power supply off and remove the hydraulic input pressure from the -8 hose connected to port 17R (front of manifold). There should not be any hydraulic pressure applied to the manifold.
54. Install the -8, 37° flare nut cap on port 21 (side of manifold).
55. This completes the 2-way solenoid valve circuit test.

## SECTION II INSTALLATION OF HDC PRIMARY MANIFOLD ASSEMBLY, MANUAL SHUT-OFF VALVE V23, AND LEFT MAIN MANIFOLD PRESSURE TRANSDUCER T7 - CONTINUED

### 3-3 PRIMARY MANIFOLD FUNCTIONALITY TESTING - CONTINUED

- c. Testing hydraulic circuits from ports C2, 3R, 3L, 17L, and 19 (all are on the front side of the manifold) to ports C2, 3R, 3L, 17L, and 19 (all are on the bottom of the manifold).

Circuit C2

1. Remove the -8, 37° flare nut cap on port C2 (front side of manifold).
2. Connect a -8, 37° flare fitting hose to port C2 (front side of manifold).
3. Connect a 28 VDC power supply to valve V14.
4. Remove the -8, 37° flare nut cap on port C2 (bottom of manifold).
5. Apply hydraulic pressure to the -8 hose port C2 (front side of manifold).
6. Observe fluid flowing from port C2 (bottom of manifold).
7. Energize the power supply. Fluid should stop coming from port C2 (bottom of manifold).
8. Read and record the T1 voltage.

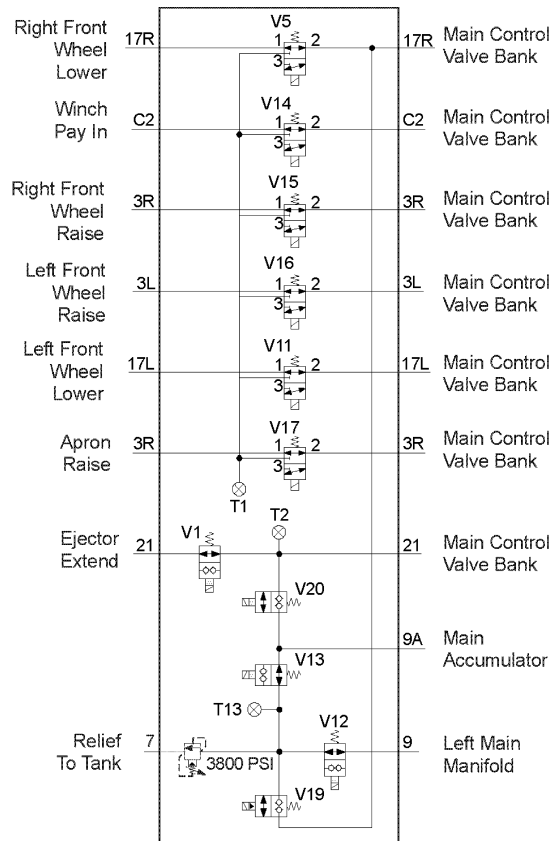

**Figure 3-9. Primary Manifold Assembly Hydraulic Schematic Diagram**

## SECTION II INSTALLATION OF HDC PRIMARY MANIFOLD ASSEMBLY, MANUAL SHUT-OFF VALVE V23, AND LEFT MAIN MANIFOLD PRESSURE TRANSDUCER T7 - CONTINUED

### 3-3 PRIMARY MANIFOLD FUNCTIONALITY TESTING - CONTINUED

9. Turn the power supply off and remove the hydraulic input pressure from the -8 hose connected to port C2 (front side of manifold). There should not be any hydraulic pressure applied to the manifold.
10. Remove the power supply cable from valve V14.
11. Install a -8, 37° flare nut cap on port C2 (bottom of manifold).
12. Disconnect the -8, 37° flare fitting hose on port C2 (front side of manifold).
13. Install a -8, 37° flare nut cap on port C2 (front side of manifold).

#### Circuit 3R

1. Remove the -8, 37° flare nut cap on port 3R (front side of manifold).
2. Connect a -8, 37° flare fitting hose to port 3R (front side of manifold).
3. Connect a 28 VDC power supply to valve V15.
4. Remove the -8, 37° flare nut cap on port 3R (bottom of manifold).
5. Apply hydraulic pressure to the -8 hose port 3R (front side of manifold).
6. Observe fluid flowing from port 3R (bottom of manifold).
7. Remove the -8, 37° flare nut cap on port 3R (front side of manifold).
8. Connect a -8, 37° flare fitting hose to port 3R (front side of manifold).
9. Connect a 28 VDC power supply to valve V15.
10. Remove the -8, 37° flare nut cap on port 3R (bottom of manifold).
11. Apply hydraulic pressure to the -8 hose port 3R (front side of manifold).
12. Observe fluid flowing from port 3R (bottom of manifold).
13. Energize the power supply. Fluid flow should stop coming from port 3R (bottom of manifold).
14. Read and record the T1 voltage.
15. Turn the power supply off and remove the hydraulic input pressure from the -8 hose connected to port 3R (front side of manifold). There should not be any hydraulic pressure applied to the manifold.
16. Remove the power supply cable from valve V15.
17. Install a -8, 37° flare nut cap on port 3R (bottom of manifold).
18. Disconnect the -8, 37° flare fitting hose on port 3R (front side of manifold).
19. Install a -8, 37° flare nut cap on port 3R (front side of manifold).

#### Circuit 3L

1. Remove the -8, 37° flare nut cap on port 3L (front side of manifold).
2. Connect a -8, 37° flare fitting hose to port 3L (front side of manifold).
3. Connect a 28 VDC power supply to valve V16.
4. Remove the -8, 37° flare nut cap on port 3L (bottom of manifold).

## SECTION II INSTALLATION OF HDC PRIMARY MANIFOLD ASSEMBLY, MANUAL SHUT-OFF VALVE V23, AND LEFT MAIN MANIFOLD PRESSURE TRANSDUCER T7 - CONTINUED

### 3-3 PRIMARY MANIFOLD FUNCTIONALITY TESTING - CONTINUED

5. Apply hydraulic pressure to the -8 hose port 3L (front side of manifold).
6. Observe fluid flowing from port 3L (bottom of manifold).
7. Remove the -8, 37° flare nut cap on port 3L (front side of manifold).
8. Connect a -8, 37° flare fitting hose to port 3L (front side of manifold).
9. Connect a 28 VDC power supply to valve V16.
10. Remove the -8, 37° flare nut cap on port 3L (bottom of manifold).
11. Apply hydraulic pressure to the -8 hose port 3L (front side of manifold).
12. Observe fluid flowing from port 3L (bottom of manifold).
13. Energize the power supply and fluid flow should stop from port 3L (bottom of manifold).
14. Read and record the T1 voltage.
15. Turn the power supply off and remove the hydraulic input pressure from the -8 hose connected to port 3L (front side of manifold). There should not be any hydraulic pressure applied to the manifold.
16. Remove the power supply cable from valve V16.

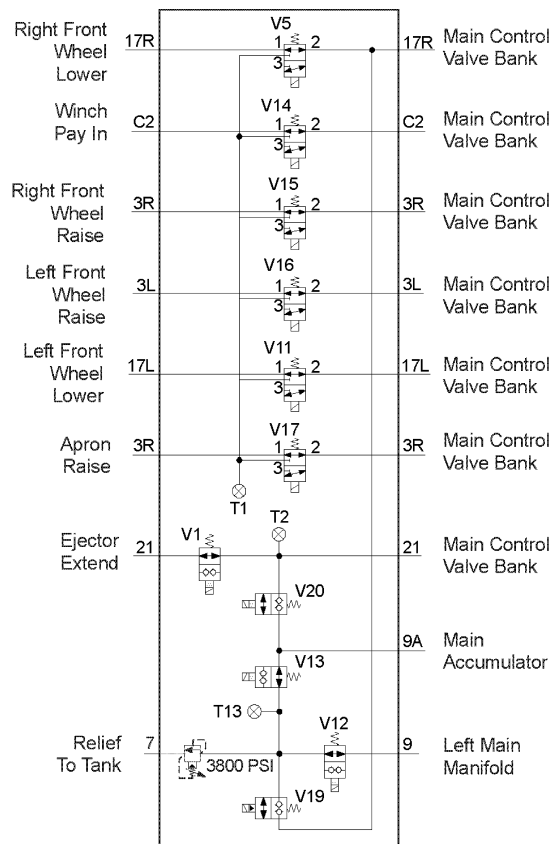

**Figure 3-9. Primary Manifold Assembly Hydraulic Schematic Diagram**



## SECTION II INSTALLATION OF HDC PRIMARY MANIFOLD ASSEMBLY, MANUAL SHUT-OFF VALVE V23, AND LEFT MAIN MANIFOLD PRESSURE TRANSDUCER T7 - CONTINUED

### 3-3 PRIMARY MANIFOLD FUNCTIONALITY TESTING - CONTINUED

17. Install a -8, 37° flare nut cap on port 3L (bottom of manifold).
18. Disconnect the -8, 37° flare fitting hose on port 3L (front side of manifold).
19. Install a -8, 37° flare nut cap on port 3L (front side of manifold).

#### Circuit 17L

1. Remove the -8, 37° flare nut cap on port 17L (front side of manifold).
2. Connect a -8, 37° flare fitting hose to port 17L (front side of manifold).
3. Connect a 28 VDC power supply to valve V11.
4. Remove the -8, 37° flare nut cap on port 17L (bottom of manifold).
5. Apply hydraulic pressure to the -8 hose port 17L (front side of manifold).
6. Observe fluid flowing from port 17L (bottom of manifold).
7. Remove the -8, 37° flare nut cap on port 17L (front side of manifold).
8. Connect a -8, 37° flare fitting hose to port 17L (front side of manifold).
9. Connect a 28 VDC power supply to valve V11.
10. Remove the -8, 37° flare nut cap on port 17L (bottom of manifold).
11. Apply hydraulic pressure of 3000 psig (20684.27 kilopascal) @ 10 GPM (37854.12 CPM) to the -8 hose port 17L (front side of manifold).
12. Observe fluid flowing from port 17L (bottom of manifold).
13. Energize the power supply. Fluid flow should stop coming from port 17L (bottom of manifold).
14. Read and record the T1 voltage.
15. Turn the power supply off and remove the hydraulic input pressure from the -8 hose connected to port 17L (front side of manifold). There should not be any hydraulic pressure applied to the manifold.
16. Remove the power supply cable from valve V11.
17. Install a -8, 37° flare nut cap on port 17L (bottom of manifold).
18. Disconnect the -8, 37° flare fitting hose on port 17L (front side of manifold).
19. Install a -8, 37° flare nut cap on port 17L (front side of manifold).

#### Circuit 19

1. Remove the -8, 37° flare nut cap on port 19 (front side of manifold).
2. Connect a -8, 37° flare fitting hose to port 19 (front side of manifold).
3. Connect a 28 VDC power supply to valve V17.
4. Remove the -8, 37° flare nut cap on port 19 (bottom of manifold).
5. Apply hydraulic pressure of 3000 psig (20684.27 kilopascal) @ 10 GPM (37854.12 CPM) to the -8 hose port 19 (front side of manifold).
6. Observe fluid flowing from port 19 (bottom of manifold).

## SECTION II INSTALLATION OF HDC PRIMARY MANIFOLD ASSEMBLY, MANUAL SHUT-OFF VALVE V23, AND LEFT MAIN MANIFOLD PRESSURE TRANSDUCER T7 - CONTINUED

### 3-3 PRIMARY MANIFOLD FUNCTIONALITY TESTING - CONTINUED

7. Energize the power supply and fluid flow should stop from port C19 (bottom of manifold).
8. Read and record the T1 voltage.
9. Turn the power supply off and remove the hydraulic input pressure from the -8 hose connected to port 19 (front side of manifold). There should not be any hydraulic pressure applied to the manifold.
10. Remove the power supply cable from valve V17.
11. Install a -8, 37° flare nut cap on port 19 (bottom of manifold).
12. Disconnect the -8, 37° flare fitting hose on port 19 (front side of manifold).
13. Install a -8, 37° flare nut cap on port 19 (front side of manifold).

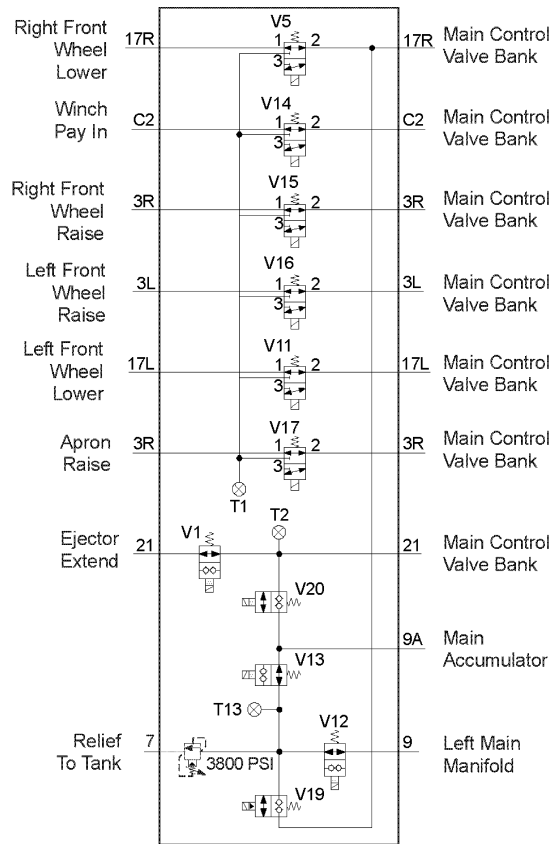

**Figure 3-9. Primary Manifold Assembly Hydraulic Schematic Diagram**

## SECTION II INSTALLATION OF HDC PRIMARY MANIFOLD ASSEMBLY, MANUAL SHUT-OFF VALVE V23, AND LEFT MAIN MANIFOLD PRESSURE TRANSDUCER T7 - CONTINUED

### 3-4 MOUNTING AND INSTALLATION OF HDC PRIMARY MANIFOLD ASSEMBLY

#### NOTE

Step a below applies to Figure 3-10 and Figure 3-11.

- a. Remove coils only from solenoid valves V11 (1) and V15 (2) on HDC primary manifold assembly, 12496943, (3) to provide access for tool clearance during installation of primary manifold assembly. Remove only from the solenoid valves. Do not remove the cartridges.

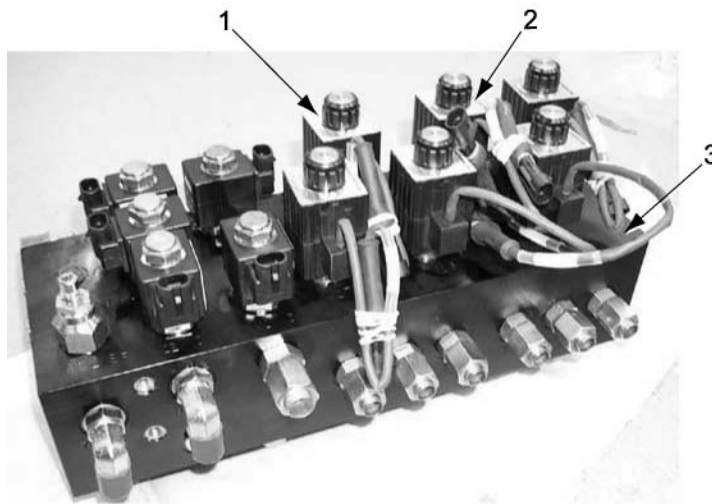

Figure 3-10. Location of Solenoid Valves V11 and V15

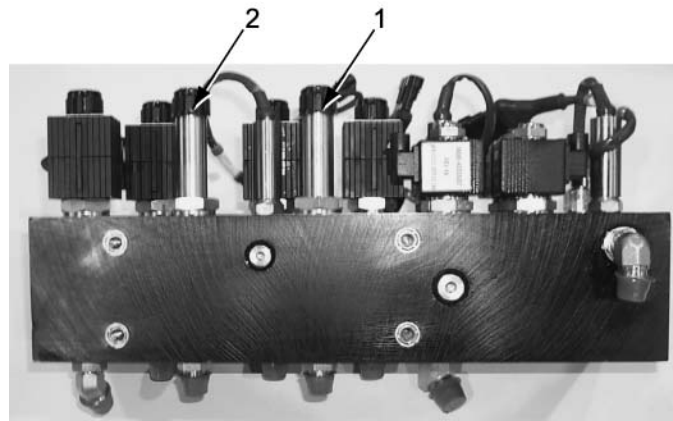

Figure 3-11. Rear View of Manifold with Coil Removed

## SECTION II INSTALLATION OF HDC PRIMARY MANIFOLD ASSEMBLY, MANUAL SHUT-OFF VALVE V23, AND LEFT MAIN MANIFOLD PRESSURE TRANSDUCER T7 - CONTINUED

### 3-4 MOUNTING AND INSTALLATION OF HDC PRIMARY MANIFOLD ASSEMBLY - CONTINUED

#### NOTE

Step b below applies to Figure 3-12.

- b. Attach primary manifold mounting plate, 12496959, (1) to back of primary manifold assembly (2) with four locking screws, B1821BH038C100L, (4) and four flat washers, 10910174-3, (3), as shown in Figure 3-12.

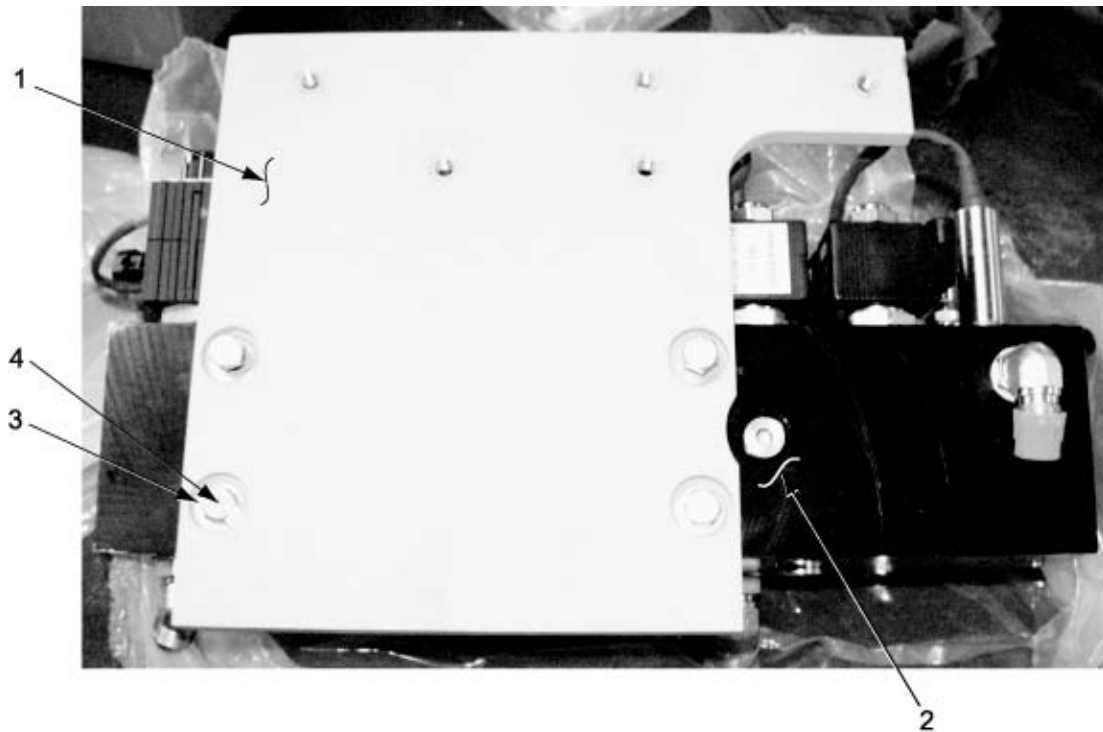

Figure 3-12. Installation of Mounting Plate on Primary Manifold Assembly

## SECTION II INSTALLATION OF HDC PRIMARY MANIFOLD ASSEMBLY, MANUAL SHUT-OFF VALVE V23, AND LEFT MAIN MANIFOLD PRESSURE TRANSDUCER T7 - CONTINUED

### 3-4 MOUNTING AND INSTALLATION OF HDC PRIMARY MANIFOLD ASSEMBLY - CONTINUED

#### NOTE

Step c below applies to Figure 3-13.

- c. Reattach clamp assembly (6) to new inboard angle bracket, 12496952, (7) with two previously removed bolts and two flat washers (hidden from view). Items 3, 4, and 5 identify the three hoses clamped in place. Items 1 and 2 are mounting hardware that attach the inboard angle bracket to vehicle hull as described below in step d.

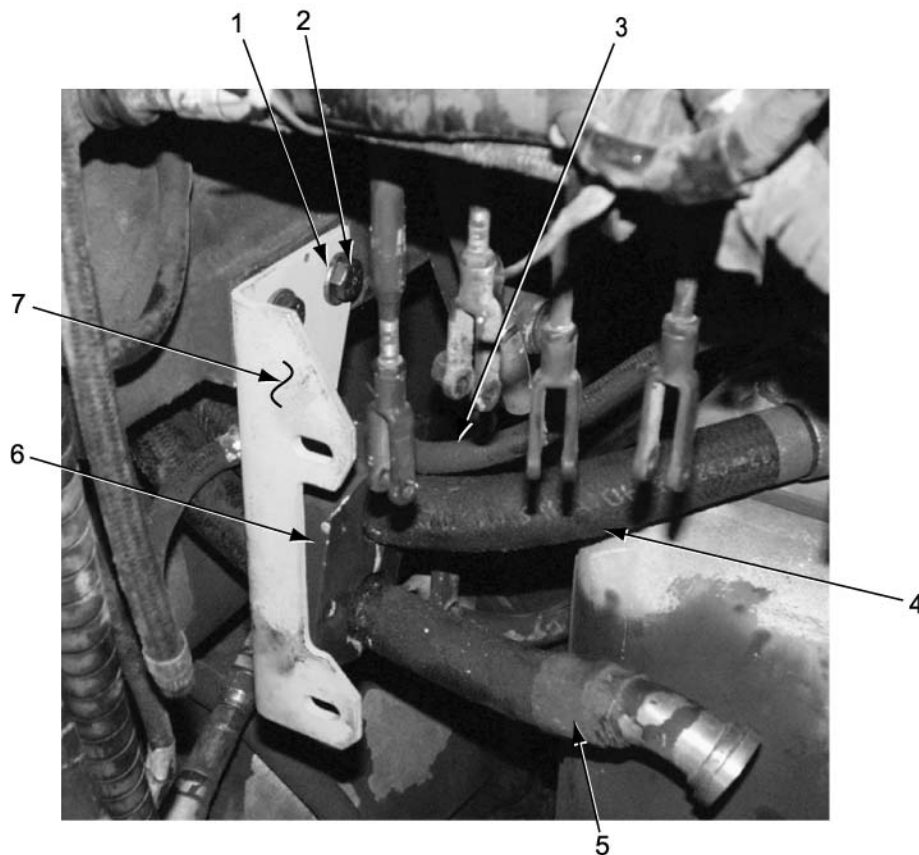

**Figure 3-13. Installation of Clamp Assembly on Inboard Angle Bracket**

#### NOTE

Steps d through f below apply to Figure 3-14 (also reference to Figure 3-13).

- d. Mount inboard angle bracket, 12496952, (1) and attached clamp assembly to existing holes in inboard portion of vehicle hull with two new locking screws, B1821BH050C113L, (3) and two flat washers, MS27183-18, (2) retained from removal of DCV bank inboard mounting bracket (Figure 3-13 shows the inboard angle bracket mounted to hull with clamp assembly attached).

## SECTION II INSTALLATION OF HDC PRIMARY MANIFOLD ASSEMBLY, MANUAL SHUT-OFF VALVE V23, AND LEFT MAIN MANIFOLD PRESSURE TRANSDUCER T7 - CONTINUED

### 3-4 MOUNTING AND INSTALLATION OF HDC PRIMARY MANIFOLD ASSEMBLY - CONTINUED

#### WARNING

Weldment bracket must be installed before attempting to install HDC primary manifold assembly to provide necessary support during installation of manifold assembly. Failure to do so could result in serious personnel injury.

- e. Attach outboard weldment bracket, 12496944, (4) to existing holes in left side (driver's left) of vehicle hull with three new locking screws, B1821BH050C113L, (5) and three flat washers, MS27183-18, (6) retained from removal of DCV bank old outboard mounting bracket.
- f. Secure outboard weldment bracket (4) to inboard angle bracket (1) with two screws, B1821BH038C125N, (7), four flat washers, 10910174-3, (8), and two self-locking nuts, MS17829-6C, (9) as shown.

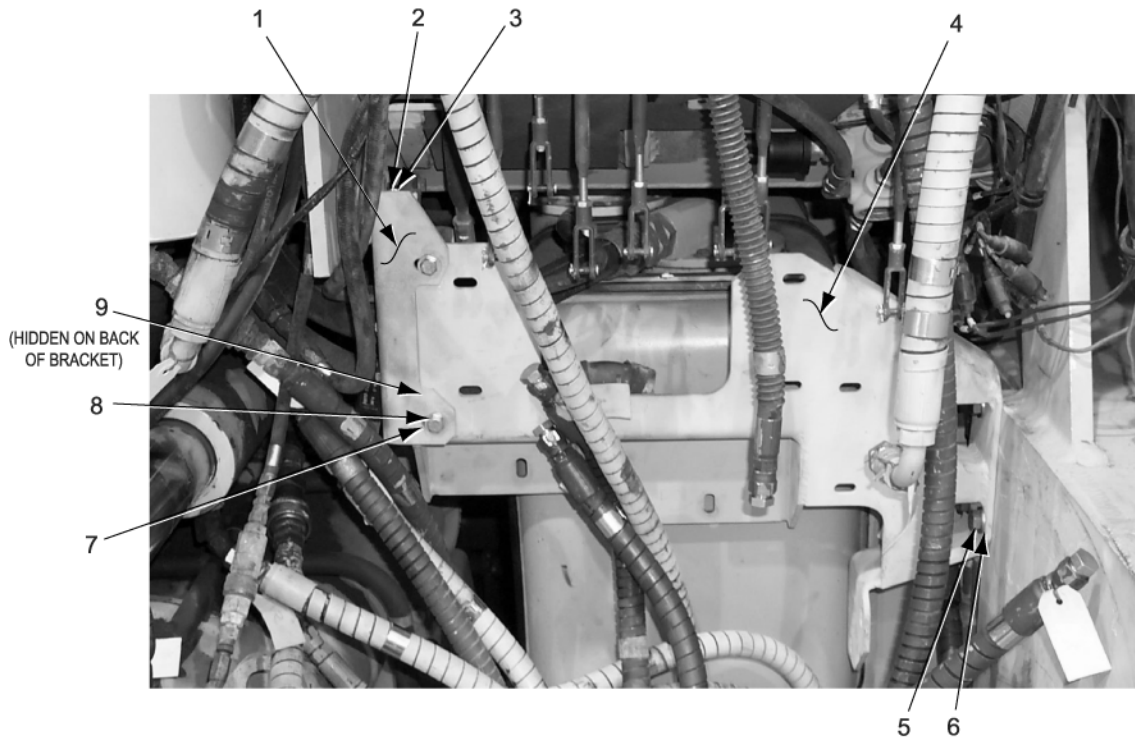

Figure 3-14. Installation of Mounting Brackets

## SECTION II INSTALLATION OF HDC PRIMARY MANIFOLD ASSEMBLY, MANUAL SHUT-OFF VALVE V23, AND LEFT MAIN MANIFOLD PRESSURE TRANSDUCER T7 - CONTINUED

### 3-4 MOUNTING AND INSTALLATION OF HDC PRIMARY MANIFOLD ASSEMBLY - CONTINUED

#### WARNING

It is necessary to fully support weight of primary manifold assembly (approximately 40 pounds) when securing manifold assembly to weldment bracket. Failure to do so could result in serious personal injury.

#### NOTE

Step g below applies to Figure 3-15.

#### NOTE

When installing primary manifold assembly, the top of the manifold assembly mounting plate should be lowered and placed behind weldment bracket and eased upward into proper installation position.

- g. Fully supporting weight of primary manifold assembly, 19496943, (4), install mounting plate, 12496959, (1) (and attached primary manifold assembly (4)) to weldment bracket, 12496944, with five locking screws, B1821BH038C100L, (2) and five flat washers, 10910174-3, (3). Do not completely tighten screws at this time.

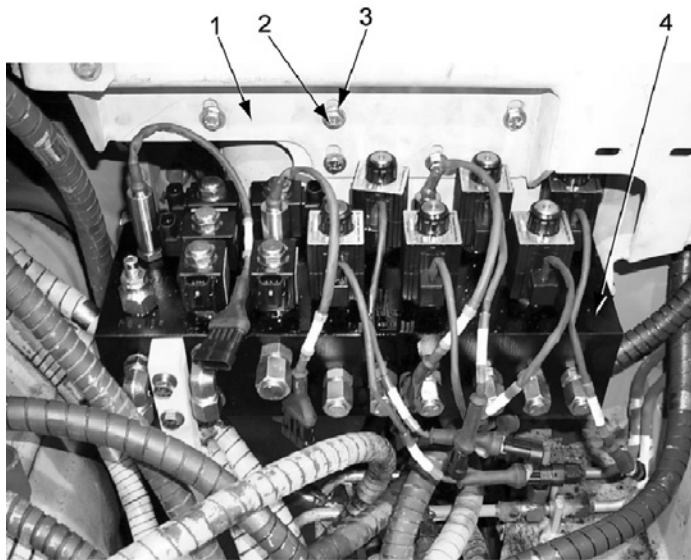

Figure 3-15. Mounting and Installation of HDC Primary Manifold Assembly

## SECTION II INSTALLATION OF HDC PRIMARY MANIFOLD ASSEMBLY, MANUAL SHUT-OFF VALVE V23, AND LEFT MAIN MANIFOLD PRESSURE TRANSDUCER T7 - CONTINUED

### 3-4 MOUNTING AND INSTALLATION OF HDC PRIMARY MANIFOLD ASSEMBLY - CONTINUED

#### NOTE

Step h below applies to Figure 3-16.

- h. Attach right support portion of outboard weldment bracket (1) to right side (vehicle left) of primary manifold assembly (4) with two locking screws, B1821BH038C100L, (3) and two flat washers, 10910174-3, (2). Do not completely tighten screws at this time.

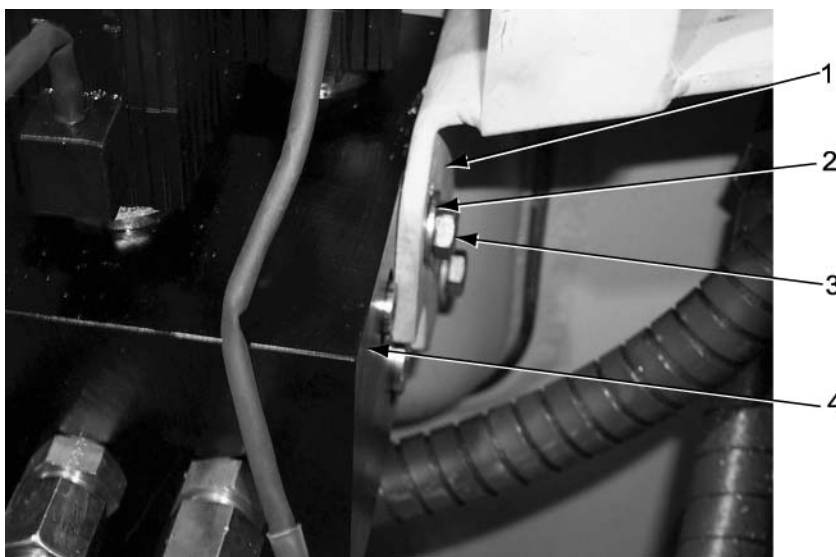

Figure 3-16. Attaching Outboard Weldment Bracket to Primary Manifold Assembly



## SECTION II INSTALLATION OF HDC PRIMARY MANIFOLD ASSEMBLY, MANUAL SHUT-OFF VALVE V23, AND LEFT MAIN MANIFOLD PRESSURE TRANSDUCER T7 - CONTINUED

### 3-4 MOUNTING AND INSTALLATION OF HDC PRIMARY MANIFOLD ASSEMBLY - CONTINUED

#### NOTE

Steps i through l below apply to Figure 3-17.

- i. Place new angle bracket (lower lateral support bracket), 12496927, (5) in position on hull floor next to left main manifold (2) as shown in Figure 3-17.
- j. Attach bottom of angle bracket (5) to hull floor using one locking screw, B1821BH050C113L, (6) and one previously removed flat washer, MS27183-18, (7).
- k. Attach side of angle bracket (5) to side of left main manifold (2) using two locking screws, B1821BH050C113L, and two retained flat washers, MS27183-18.
- l. Attach lower end of brace (lateral support bracket), 12496924, (1) to new angle bracket (5) using one screw, B1821BH050C250N (8), five flat washers, 10910174-5, (3) (as shown) and one self-locking nut, MS17829-8C, (4). Do not completely tighten screw at this time.

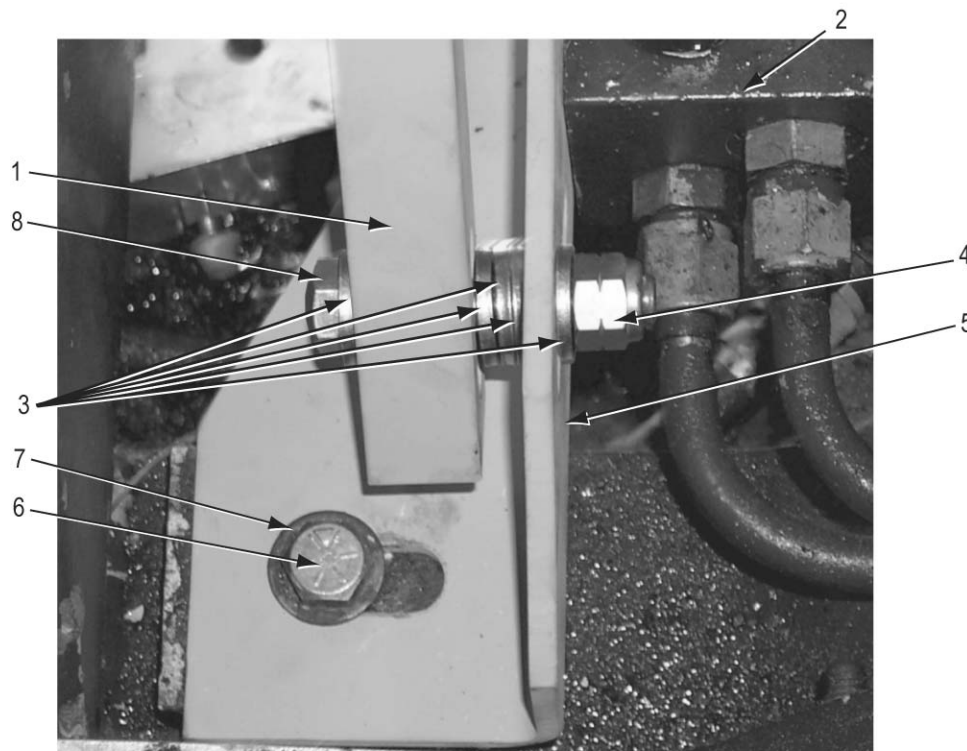

**BOTTOM**

**Figure 3-17. Installation of Primary Manifold Brace**

## SECTION II INSTALLATION OF HDC PRIMARY MANIFOLD ASSEMBLY, MANUAL SHUT-OFF VALVE V23, AND LEFT MAIN MANIFOLD PRESSURE TRANSDUCER T7 - CONTINUED

### 3-4 MOUNTING AND INSTALLATION OF HDC PRIMARY MANIFOLD ASSEMBLY - CONTINUED

#### NOTE

Steps m and n below apply to Figure 3-18.

- m. Attach upper end of brace (4) to primary manifold assembly (1) using two locking screws, B1821BH038C200, (3) and two flat washers, 10910174-3, (2).
- n. Install 90° swivel, MS51521A10, (5) on primary manifold port 21 (front).

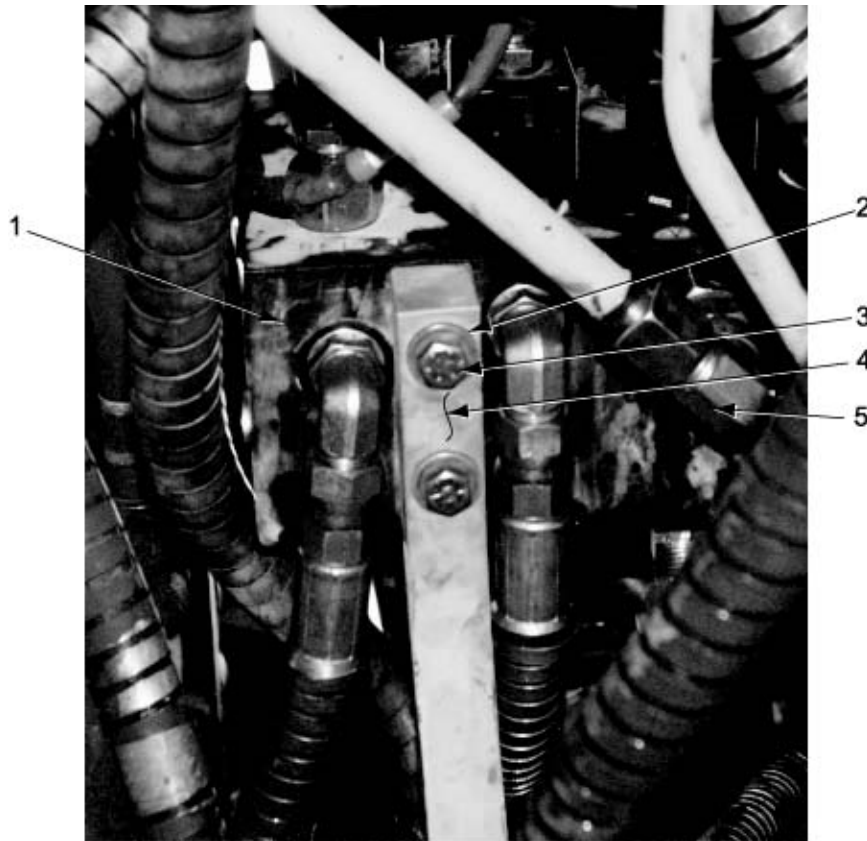

Figure 3-18. Installation of Upper portion of Brace

## SECTION II INSTALLATION OF HDC PRIMARY MANIFOLD ASSEMBLY, MANUAL SHUT-OFF VALVE V23, AND LEFT MAIN MANIFOLD PRESSURE TRANSDUCER T7 - CONTINUED

### 3-5 DIRECTIONAL CONTROL VALVE MODIFICATION - INSTALLATION OF MANUAL SHUT-OFF VALVE V23

#### NOTE

Steps a and b below apply to Figure 3-19. Reference should also be made to Figure 3-2.

#### NOTE

To reduce maintenance activities in the bowl area, the DCV bank modification should be performed on a bench (prior to installing the DCV bank in the bowl).

- a. Install 45° elbow, MS51528B8, (3) and o-ring, MS28778-8, (4) on DCV bank winch pay-out port C1, with elbow pointing down.
- b. Install short straight adapter, MS51525B10 (1), o-ring, MS28778-10, (2), and previously removed elbow, MS51521A10, (5) on DCV bank ejector forward port 21. Orient elbow (not shown on Figure 3-19) to face 90° upward.

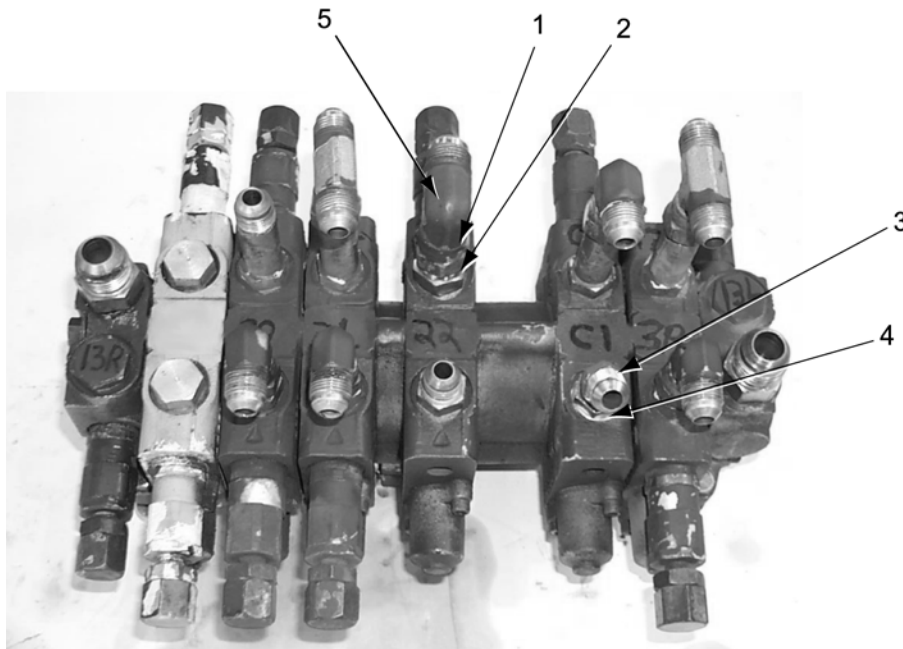

Figure 3-19. Modifications to DCV Bank

## SECTION II INSTALLATION OF HDC PRIMARY MANIFOLD ASSEMBLY, MANUAL SHUT-OFF VALVE V23, AND LEFT MAIN MANIFOLD PRESSURE TRANSDUCER T7 - CONTINUED

### 3-5 DIRECTIONAL CONTROL VALVE MODIFICATION - INSTALLATION OF MANUAL SHUT-OFF VALVE V23 - CONTINUED

#### NOTE

Steps c through f below apply to Figure 3-20.

#### NOTE

No modification is required to manual ball valve V23. The ball valve functions in a right hand configuration as supplied.

- c. Install 90° swivel adapter, 8AOEX6, (2) and o-ring, MS28778-8, (3) on top of manual ball valve, BVHP-08-SSS-1NG, (4). This ball valve is functionally designated as V23.
- d. Install 90° adapter, MS51527A8, (7) and o-ring, MS28778-8, (6) on bottom of manual ball valve (4).
- e. Install manual ball valve (4) with attached 90° adapters (2 and 7) on DCV bank ejector valve port 22 (ejector retract) (1).
- f. Place "V23 EJECTOR" marker, 12496928-3, (5) on flat portion of manual ball valve (3).

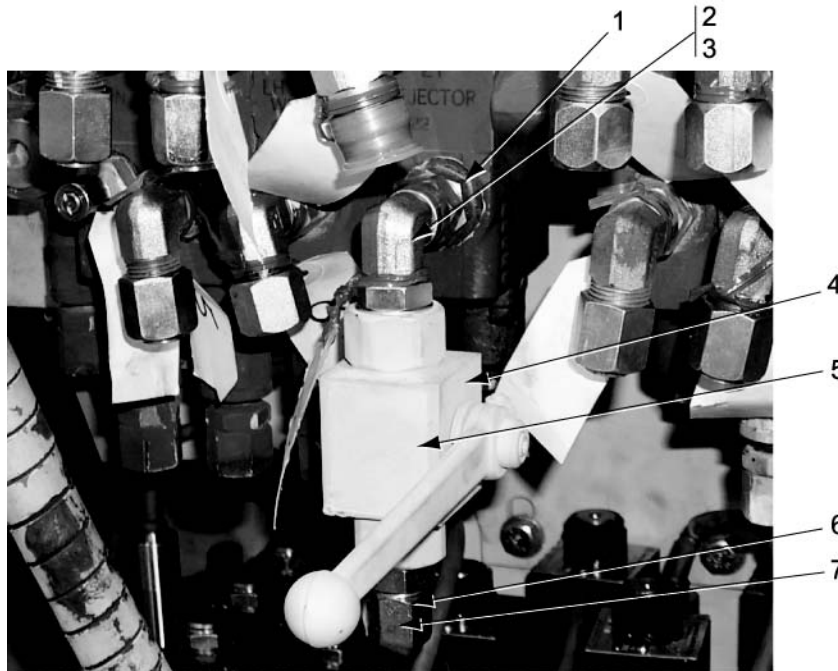

Figure 3-20. Manual Shut-Off Ball Valve V23 Installation

## SECTION II INSTALLATION OF HDC PRIMARY MANIFOLD ASSEMBLY, MANUAL SHUT-OFF VALVE V23, AND LEFT MAIN MANIFOLD PRESSURE TRANSDUCER T7 - CONTINUED

### 3-6 MOUNTING OF DIRECTIONAL CONTROL VALVE (DCV) BANK AND SUSPENSION VALVE

#### WARNING

The DCV bank weighs approximately 60 pounds. It is necessary to fully support the weight of the directional control valve bank when securing the bank to the weldment bracket. Failure to do so could result in serious personal injury.

#### NOTE

Steps a through c below apply to Figure 3-21.

- a. Fully supporting entire weight of DCV bank, place hose (1), o-ring, MS28775-219, (5), (hidden inside pipe flange) and split pipe flange (3) in position on back of DCV bank (4).
- b. Install split pipe flange (3) around hose (1) and o-ring (5) with four locking screws, B1821BH038C125L, (2) and four saved flat washers (7) on rear of DCV bank.
- c. Continuing to support weight of DCV bank, connect second hose (6) to same area on back of DCV bank (4).

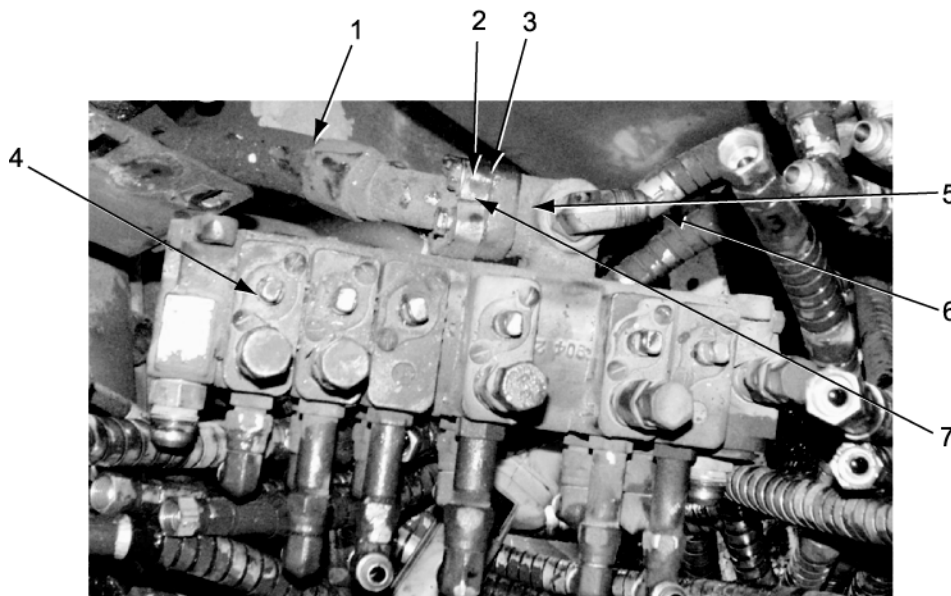

Figure 3-21. DCV Bank Mounting Connections

## SECTION II INSTALLATION OF HDC PRIMARY MANIFOLD ASSEMBLY, MANUAL SHUT-OFF VALVE V23, AND LEFT MAIN MANIFOLD PRESSURE TRANSDUCER T7 - CONTINUED

### 3-6 MOUNTING OF DIRECTIONAL CONTROL VALVE (DCV) BANK AND SUSPENSION VALVE - CONTINUED

#### NOTE

Steps d and e below apply to Figure 3-22 (Upper).

- d. Fully supporting the entire weight of DCV bank, install DCV bank (1) on weldment bracket with four saved hex cap screws, B1821BH038C150N, (2), four saved flat washers, MS27183-14, (4), and four new self-locking nuts, MS17829-6C, (3). Callout (6) shows location of another set of DCV bank mounting hardware on upper portion of weldment bracket. Do not completely tighten hex cap screws at this time. Refer to TM 5-2350-262-20-2, Directional Control Valve Replacement.
- e. Attach mechanical control linkages to DCV bank valves with six cotter pins, MS24665-132, (5), and adjust linkages as necessary. Refer to TM 5-2350-262-20-2, Hydraulic Control Levers and Linkage Adjustment, if necessary to adjust linkages.

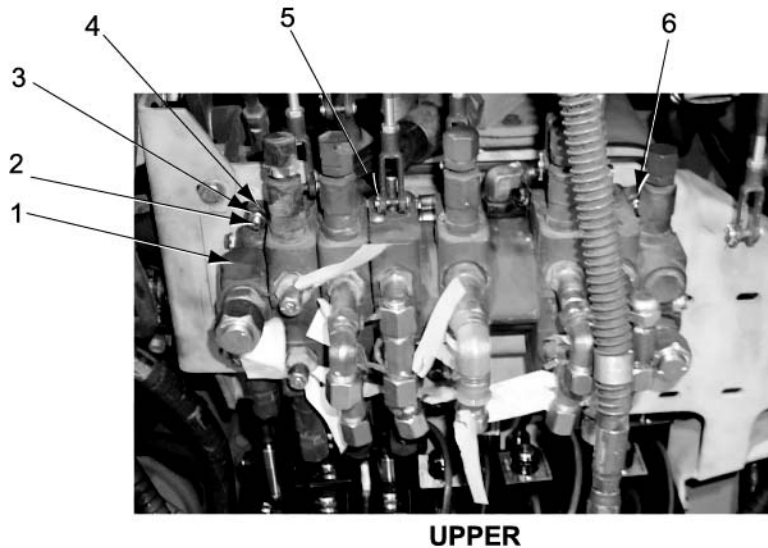

Figure 3-22. Mounting of DCV Bank and Suspension (Sprung/Unsprung) Valve/Upper View)

## SECTION II INSTALLATION OF HDC PRIMARY MANIFOLD ASSEMBLY, MANUAL SHUT-OFF VALVE V23, AND LEFT MAIN MANIFOLD PRESSURE TRANSDUCER T7 - CONTINUED

### 3-6 MOUNTING OF DIRECTIONAL CONTROL VALVE (DCV) BANK AND SUSPENSION VALVE - CONTINUED

#### NOTE

Steps f and g below apply to Figure 3-23 (Lower).

- f. Install suspension (sprung/unsprung) valve (5) on weldment bracket with four saved hex cap screws, B1821BH038C150N, (4), four saved flat washers, MS27183-14, (1), and four new self-locking nuts, MS17829-6C, (3). Do not completely tighten hex cap screws at this time. Refer to TM 5-2350-262-20-2, Sprung/Unsprung Valve Replacement.
- g. Install previously removed hydraulic hoses on suspension (sprung/unsprung) valve and attach mechanical control linkage to valve with cotter pin, MS24665-132, (2). Adjust linkage as necessary. Refer to TM 5-2350-262-20-2, Hydraulic Control Levers and Linkage Adjustment, if necessary to adjust linkage.

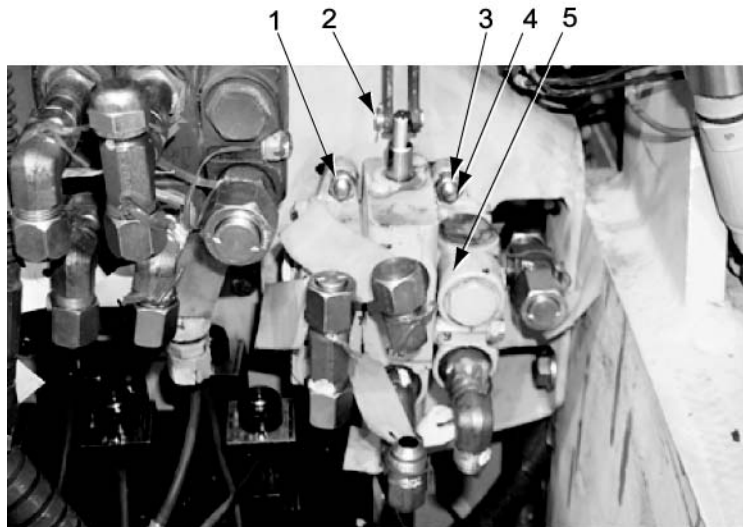

LOWER

Figure 3-23. Mounting of DCV Bank and Suspension (Sprung/Unsprung) Valve/Lower View)

## SECTION II INSTALLATION OF HDC PRIMARY MANIFOLD ASSEMBLY, MANUAL SHUT-OFF VALVE V23, AND LEFT MAIN MANIFOLD PRESSURE TRANSDUCER T7 - CONTINUED

### 3-7 INITIAL INTERCONNECTION AND ALIGNMENT OF HDC PRIMARY MANIFOLD ASSEMBLY AND DIRECTIONAL CONTROL VALVE (DCV) BANK

#### CAUTION

It is important that HDC primary manifold assembly and directional control valve bank be properly aligned during installation to allow rigid hydraulic tubes to be properly installed and to fit properly. Damage to equipment could result from improper installation.

#### NOTE

All hydraulic tubes (hard lines) between primary manifold assembly and DCV bank should be installed before installing any hydraulic hoses on primary manifold assembly.

#### NOTE

It may be necessary to apply slight pressure to various hydraulic components during installation to obtain proper fit and correct physical alignment.

#### NOTE

Steps a through p below apply to Figure 3-24 and 3-25, and to Table 3-1.

#### NOTE

All connections below are made to front of primary manifold assembly and to DCV bank.

- a. Where applicable, replace identification and destination tags (band markers) attached to existing hydraulic hoses that are rerouted and/or relocated as part of modification. Band markers are contained in Bowl Area Band Marker Kit, 12496929.
- b. Install small hydraulic tube, 12496940, (Figure 3-24 (8)) between tube tee on port 17L of left suspension raise/lower control valve on DCV bank and port 17L of HDC primary manifold assembly (Figure 3-25). Ensure tube tee connector on valve is perpendicular to the DCV bank, by applying slight lateral pressure to the DCV bank and/or the primary manifold assembly. Adjust HDC primary manifold assembly up or down as necessary to ensure the fittings align with the tube. Do not completely tighten hex cap screws at this time.
- c. Install another small hydraulic tube, 12496940, (Figure 3-24 (4)) between tube tee on port 17R of left suspension raise/lower control valve on DCV bank and port 17R on HDC primary manifold assembly (Figure 3-25). Ensure tee connector on valve is perpendicular to the DCV bank, by applying slight lateral pressure to the DCV bank and/or the primary manifold assembly. Adjust HDC primary manifold assembly up or down as necessary to ensure the fittings align with the tube. Do not completely tighten hex cap screws at this time.
- d. Install previously removed rigid tube line, 13211E9565, (Figure 3-24 (1)) on DCV bank between upper end of port tube tee on port 17L of left suspension raise/lower control valve and port 17L (Figure 3-25) on suspension valve. If necessary, carefully adjust physical position of DCV bank and HDC primary manifold assembly.



## SECTION II INSTALLATION OF HDC PRIMARY MANIFOLD ASSEMBLY, MANUAL SHUT-OFF VALVE V23, AND LEFT MAIN MANIFOLD PRESSURE TRANSDUCER T7 - CONTINUED

### 3-7 INITIAL INTERCONNECTION AND ALIGNMENT OF HDC PRIMARY MANIFOLD ASSEMBLY AND DIRECTIONAL CONTROL VALVE (DCV) BANK - CONTINUED

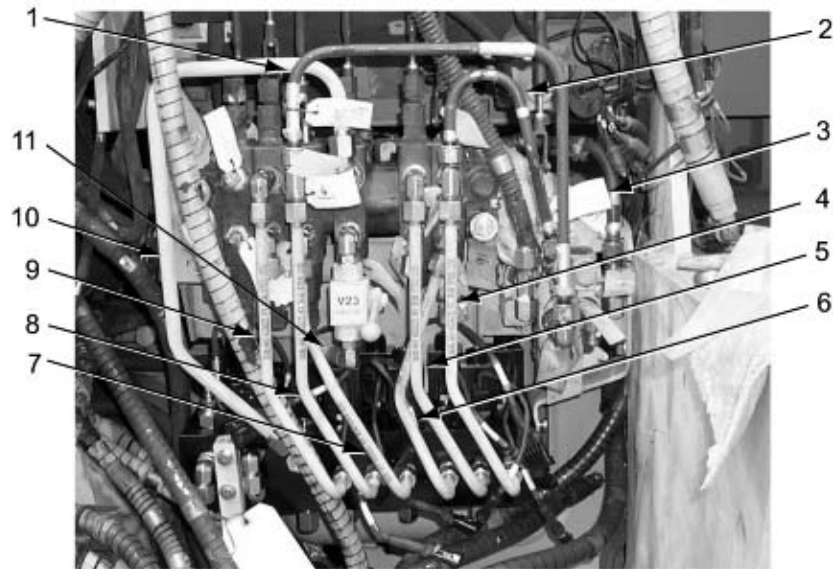

**Figure 3-24. Installation of HDC Primary Manifold Assembly Hydraulic Tubes and Hoses**

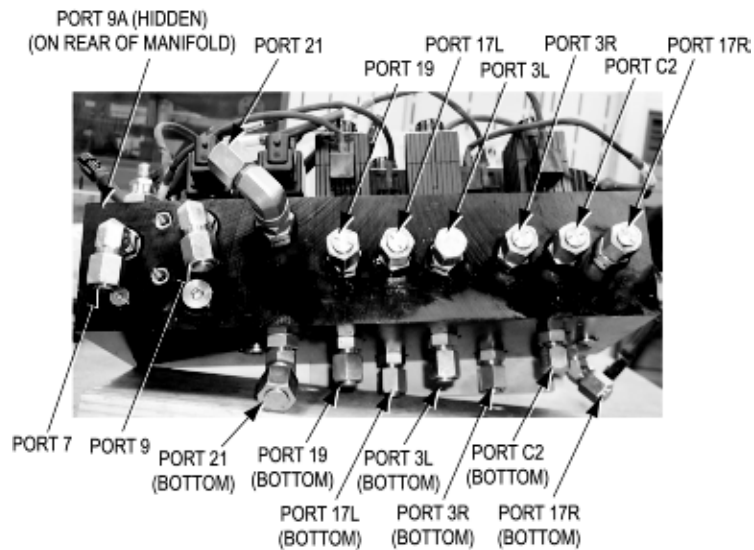

**Figure 3-25. Identification of HDC Primary Manifold Assembly ports**

## **SECTION II INSTALLATION OF HDC PRIMARY MANIFOLD ASSEMBLY, MANUAL SHUT-OFF VALVE V23, AND LEFT MAIN MANIFOLD PRESSURE TRANSDUCER T7 - CONTINUED**

### **3-7 INITIAL INTERCONNECTION AND ALIGNMENT OF HDC PRIMARY MANIFOLD ASSEMBLY AND DIRECTIONAL CONTROL VALVE (DCV) BANK - CONTINUED**

- e. Install previously removed rigid tube line, 13211E9564, (Figure 3-24 (2)) between upper end of port tube tee on port 17R (Figure 3-25) of right suspension raise/lower control valve on DCV bank and port 17R (Figure 3-25) on suspension valve. If necessary, carefully adjust physical alignment of DCV bank and HDC primary manifold assembly.
- f. While ensuring that tee connectors attached to DCV bank valves remain perpendicular to DCV bank, tighten attaching hardware that secures DCV bank and HDC primary manifold assembly to mounting weldment and supporting members in the bowl.
- g. Install coils on solenoid valves V11 (1) and V15 (2) on HDC primary manifold assembly, 12496943, (3). Refer to Figure 3-10 if necessary.
- h. Install previously removed hydraulic hose on port C1 (winch pay out) on DCV bank winch control valve.

#### **NOTE**

The other end of the hose installed in step i below connects to a circuit 20 tee connector as shown in Figure 3-26. It may be necessary to re-orient the circuit 20 tee connector 45° to the bottom of the bowl as shown in Figure 3-26.

- i. Install previously removed hydraulic hose on port 20 (lower apron) on DCV bank apron control valve.
- j. Install previously removed hydraulic hose, 13214E2457-9, (originally connected directly to DCV bank port 22 (Figure 3-25) (ejector retract) to 90° adapter (Figure 3-24 (11)) attached to bottom of ball valve V23 on DCV bank port 22.
- k. Install diagonal hydraulic tube, 12496939, (Figure 3-24 (6)) between primary manifold assembly port 3R (Figure 3-25) and DCV bank right front wheel raise (suspension) line 3R.
- l. Install small hydraulic tube, 12496940, (Figure 3-24 (9)) between primary manifold assembly port 19 (Figure 3-25) and DCV bank apron valve line 19.
- m. Install small hydraulic tube, 12496940, (Figure 3-24 (5)) between primary manifold assembly port C2 (Figure 3-25) and DCV bank winch pay-in line C2.
- n. Install small diagonal hydraulic tube, 12496963, (Figure 3-24 (7)), between primary manifold assembly port 3L (Figure 3-25) and DCV bank left front wheel raise (suspension) line 3L.
- o. Install large hydraulic tube, 12496941, (Figure 3-24 (10)) between primary manifold assembly port 21 (Figure 3-25) and DCV bank valve ejector extend control valve line 21.
- p. Ensure that previously removed hydraulic hose, 13214E9566, (Figure 3-24 (3)) is reconnected as shown between pipe tee on right side of suspension (sprung/unsprung) valve and top of right suspension raise/lower control valve on DCV bank.

## **SECTION II INSTALLATION OF HDC PRIMARY MANIFOLD ASSEMBLY, MANUAL SHUT-OFF VALVE V23, AND LEFT MAIN MANIFOLD PRESSURE TRANSDUCER T7 - CONTINUED**

### **3-8 CONNECTION OF OTHER HYDRAULIC COMPONENTS TO HDC PRIMARY MANIFOLD ASSEMBLY AND DCV BANK**

#### **NOTE**

Step a below applies to Figure 3-26, and Table 3-1.

- a. Locate hydraulic hoses and tubes identified in Table 3-1, re-tag hoses as applicable, and connect to HDC primary manifold assembly and DCV bank ports, as indicated.

#### **NOTE**

Due to limited space, it may be necessary to re-route some hoses to ensure proper connection of hoses and tubes.

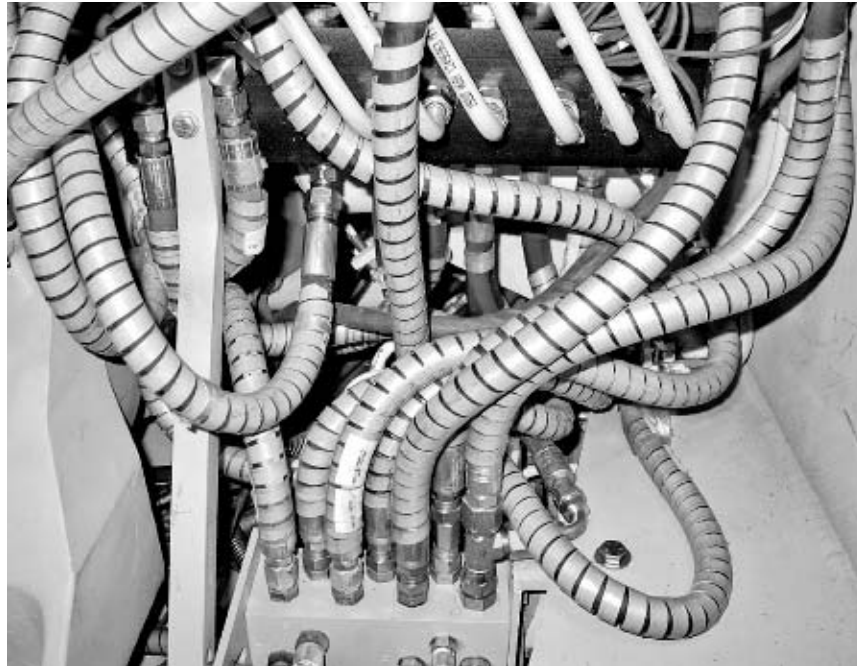

**Figure 3-26. Installation of HDC Primary Manifold Assembly Hydraulic Tubes and Hoses**

**SECTION II INSTALLATION OF HDC PRIMARY MANIFOLD ASSEMBLY, MANUAL SHUT-OFF VALVE V23, AND LEFT MAIN MANIFOLD PRESSURE TRANSDUCER T7 - CONTINUED**

**3-8 CONNECTION OF OTHER HYDRAULIC COMPONENTS TO HDC PRIMARY MANIFOLD ASSEMBLY AND DCV BANK - CONTINUED**

**Table 3-1. HDC Primary Manifold Assembly Hydraulic Connections**

<b>Hose/Tube</b>	<b>From Primary Manifold port Labeled:</b>	<b>To</b>	<b>Notes</b>
13214E2457-18	7 (front, facing open bowl area)	To left main manifold rear port 7 tee (relief to tank)	New Hose
13214E2457-19	9 (front)	Pressure Comp. Pump. To left main manifold Line 9 rear tee	New Hose
12496941	21 (front)	Ejector extend. To DCV bank Line 21	New Tube
12496940	19 (front)	Apron raise. To DCV bank Line 19	New Tube
12496940	17L (front)	Left front wheel lower (suspension). To DCV bank Line 17L	New Tube
12496963	3L (front)	Left front wheel raise (suspension). To DCV bank Line 3L	New Tube
12496939	3R (front)	Right front wheel raise (suspension). To DCV bank Line 3R	New Tube
12496940	C2 (front)	Winch pay in. To DCV bank Line C2	New Tube
12496940	17R (front)	Right front wheel lower (suspension). To DCV bank Line 17R	New Tube
13214E2457-21 (changed from 13214E2457-9)	17R (bottom)	Lower right front wheel port 17R left main manifold (top side)	Re-tag and re-route hose
13214E2478-3 (changed from 13214E2478-2)	C2 (bottom)	Winch manifold (rear) port C2.	Re-tag and re-route hose
13214E2457-24 (changed from 13214E2457-13)	3R (bottom)	Raise right front wheel. port 3R left main manifold	Re-tag and re-route hose
13214E2457-25 (changed from 13214E2457-14)	3L (bottom)	Raise left front wheel. port 3L left main manifold (top side)	Re-tag and re-route hose
13214E2457-23 (changed from 13214E2457-11)	17L (bottom)	Lower left front wheel. port 17L left main manifold	Re-tag and re-route hose
13214E2457-22 (changed from 13214E2457-10)	19 (bottom)	Raise apron. Tee on line 19	Re-tag and re-route hose

**SECTION II INSTALLATION OF HDC PRIMARY MANIFOLD ASSEMBLY,  
MANUAL SHUT-OFF VALVE V23, AND LEFT MAIN MANIFOLD PRESSURE  
TRANSDUCER T7 - CONTINUED**

**3-8 CONNECTION OF OTHER HYDRAULIC COMPONENTS TO HDC PRIMARY  
MANIFOLD ASSEMBLY AND DCV BANK - CONTINUED**

**Table 3-1. HDC Primary Manifold Assembly Hydraulic Connections - Continued**

<b>Hose/Tube</b>	<b>From Primary Manifold port Labeled:</b>	<b>To</b>	<b>Notes</b>
13214E2473-3 (changed from 13214E2473-2)	21 (bottom)	To base of ejector cylinder. Line 21	Re-tag and re-route hose
13214E2457-20 (changed from 13214E2457-4)	9A (back)	To main accumulator Line 9A	Re-tag and re-route hose

## SECTION II INSTALLATION OF HDC PRIMARY MANIFOLD ASSEMBLY, MANUAL SHUT-OFF VALVE V23, AND LEFT MAIN MANIFOLD PRESSURE TRANSDUCER T7 - CONTINUED

### 3-8 CONNECTION OF OTHER HYDRAULIC COMPONENTS TO HDC PRIMARY MANIFOLD ASSEMBLY AND DCV BANK - CONTINUED

#### NOTE

Steps b through d apply to Figure 3-27.

#### NOTE

Due to existing hose lengths and space constraints, it may be necessary to remove and re-route some left main manifold hoses to make connections.

- b. Tag and disconnect hydraulic hoses connected to ports 3L, 3R, 17L, 17R and 7 on top of left main manifold.
- c. Install 90° swivel, MS51521A10, on left main manifold top port 7.
- d. Install 90° swivel, MS51521A8, on left main manifold top ports 3L, 3R, 17L and 17R.

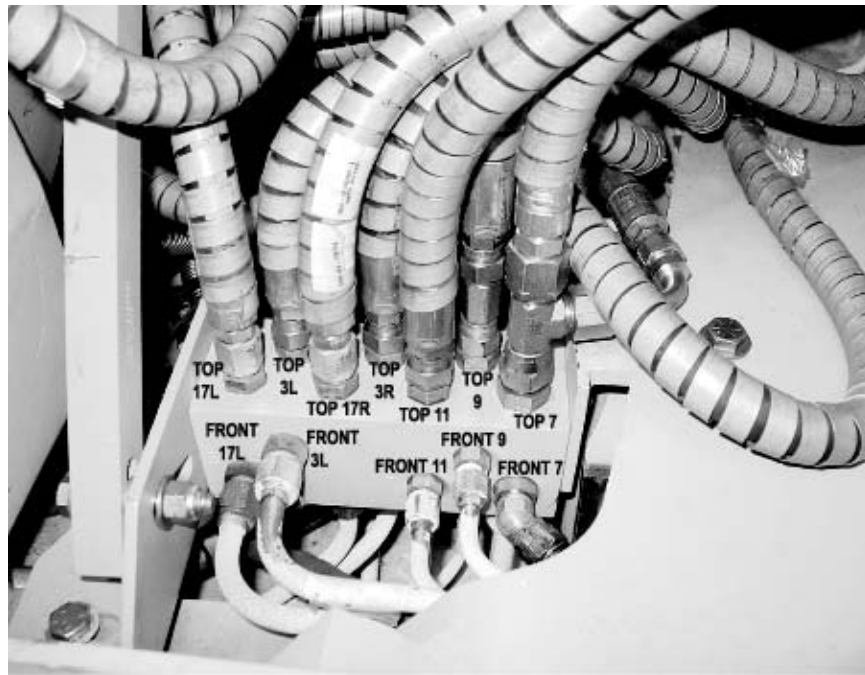

Figure 3-27. Left Main Manifold porting (Before Modification)

## SECTION II INSTALLATION OF HDC PRIMARY MANIFOLD ASSEMBLY, MANUAL SHUT-OFF VALVE V23, AND LEFT MAIN MANIFOLD PRESSURE TRANSDUCER T7 - CONTINUED

### 3-8 CONNECTION OF OTHER HYDRAULIC COMPONENTS TO HDC PRIMARY MANIFOLD ASSEMBLY AND DCV BANK - CONTINUED

#### NOTE

Step e below applies to Figure 3-28.

- e. Install new hydraulic hose, 13214E2457-18, (2) between port 7 of primary manifold assembly and tee on port 7 of left main manifold (rear side). It may be necessary to orient tee to approximate three o'clock position (90°). Item (1) identifies new hydraulic hose, 13214E2457-19.

#### NOTE

It may be necessary to remove other hydraulic hoses connected to left main manifold to facilitate modification. All hydraulic hoses that need to be removed should be identified and tagged for later reconnection.



Rear view as seen from the access hole under the hull

Figure 3-28. Installation of Hydraulic Hose 13214E2457-18

## SECTION II INSTALLATION OF HDC PRIMARY MANIFOLD ASSEMBLY, MANUAL SHUT-OFF VALVE V23, AND LEFT MAIN MANIFOLD PRESSURE TRANSDUCER T7 - CONTINUED

### 3-8 CONNECTION OF OTHER HYDRAULIC COMPONENTS TO HDC PRIMARY MANIFOLD ASSEMBLY AND DCV BANK - CONTINUED

#### NOTE

Steps f through l below apply to Figure 3-29.

- f. Access left main manifold and locate hydraulic hose that connects to line 9 on manifold.
- g. Tag and remove any additional hydraulic hoses connected to left main manifold that restrict access to line 9 on manifold.
- h. Tag and disconnect straight end of hydraulic hose 9 from tee connector (left main manifold rear-9 tee) connected to left main manifold.
- i. Attach diagnostic tee adapter, 8-4HXH6G5TP, (2) to existing tee connector attached to port for line 9 on left main manifold.
- j. Install o-ring, MS28778-4, (3) on pressure transducer, 12496923, (1). This pressure transducer is functionally designated as T7.
- k. Install pressure transducer (1) in 90° port of diagnostic tee adapter (2).
- l. Connect straight end of hydraulic hose 9 (removed in step h above) to in-line port of diagnostic tee adapter (1) attached to line 9 of left main manifold.



Rear view as seen from the access hole under the hull

Figure 3-29. Installation of Left Main Manifold Pressure Transducer T7



## **SECTION II INSTALLATION OF HDC PRIMARY MANIFOLD ASSEMBLY, MANUAL SHUT-OFF VALVE V23, AND LEFT MAIN MANIFOLD PRESSURE TRANSDUCER T7 - CONTINUED**

### **3-8 CONNECTION OF OTHER HYDRAULIC COMPONENTS TO HDC PRIMARY MANIFOLD ASSEMBLY AND DCV BANK - CONTINUED**

#### **NOTE**

Steps m through o below apply to Figure 3-30.

#### **NOTE**

Pressure relief valve is being relocated and pressure setting will have to be readjusted. Plug on relief valve should not be removed until it is determined if it is required for pressure adjustment.

- m. Disconnect and remove pressure relief valve 1A32-FBT-60SV917 (and other items shown shaded) from lower bowl area (behind left main manifold). Refer to TM 5-2350-262-20-2. Figure 3-30 is an interconnection diagram of the pressure relief valve and associated components before modification. Retain the pressure relief valve; it will be relocated to hydraulic filter area.
- n. Remove and discard three o-rings, MS28778-8, from pressure relief valve.
- o. Remove and discard metal tube assembly 12332101, tube-to-boss tee MS51530A8S, and o-ring MS28778-8. Remove and discard metal tube assembly 13214E2842, if not previously removed in step m.

## SECTION II INSTALLATION OF HDC PRIMARY MANIFOLD ASSEMBLY, MANUAL SHUT-OFF VALVE V23, AND LEFT MAIN MANIFOLD PRESSURE TRANSDUCER T7 - CONTINUED

### 3-8 CONNECTION OF OTHER HYDRAULIC COMPONENTS TO HDC PRIMARY MANIFOLD ASSEMBLY AND DCV BANK - CONTINUED

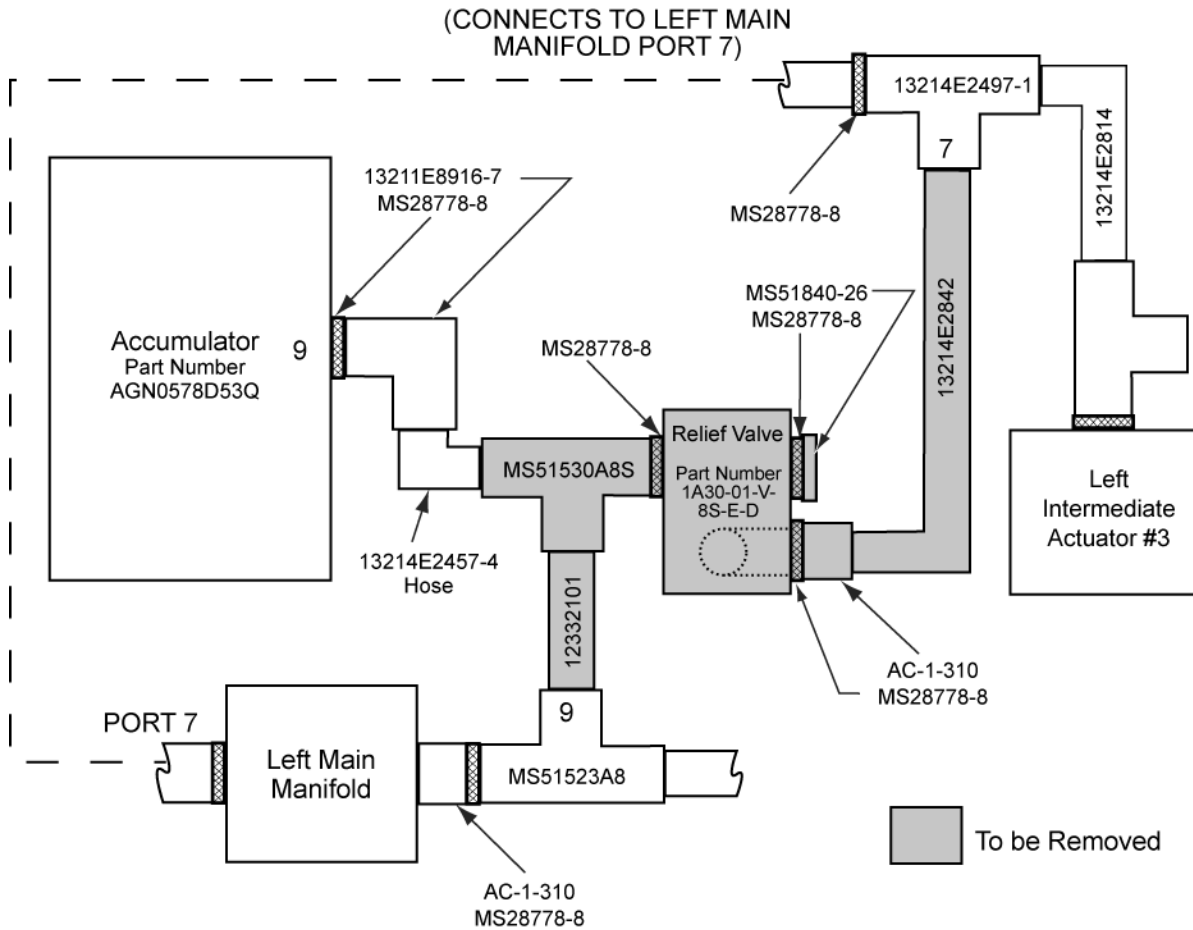

Figure 3-30. Pressure Relief Valve and Associated Components Interconnection Before Modification

## SECTION II INSTALLATION OF HDC PRIMARY MANIFOLD ASSEMBLY, MANUAL SHUT-OFF VALVE V23, AND LEFT MAIN MANIFOLD PRESSURE TRANSDUCER T7 - CONTINUED

### 3-8 CONNECTION OF OTHER HYDRAULIC COMPONENTS TO HDC PRIMARY MANIFOLD ASSEMBLY AND DCV BANK - CONTINUED

#### CAUTION

If a hydraulic test stand or other hydraulic facilities are not available to adjust the pressure relief valve setting, the adjustment should be made when the pressure relief valve is installed.

#### NOTE

Step p below applies to Figure 3-31.

- p. Using hydraulic test stand, or other available hydraulic facilities, set pressure relief valve to 4300 +/- 50 psi (29647.46 +/- 344.7379 kilopascal), at 5 +/- 2 GPM (18927.06 +/- 7570.824 CPM).

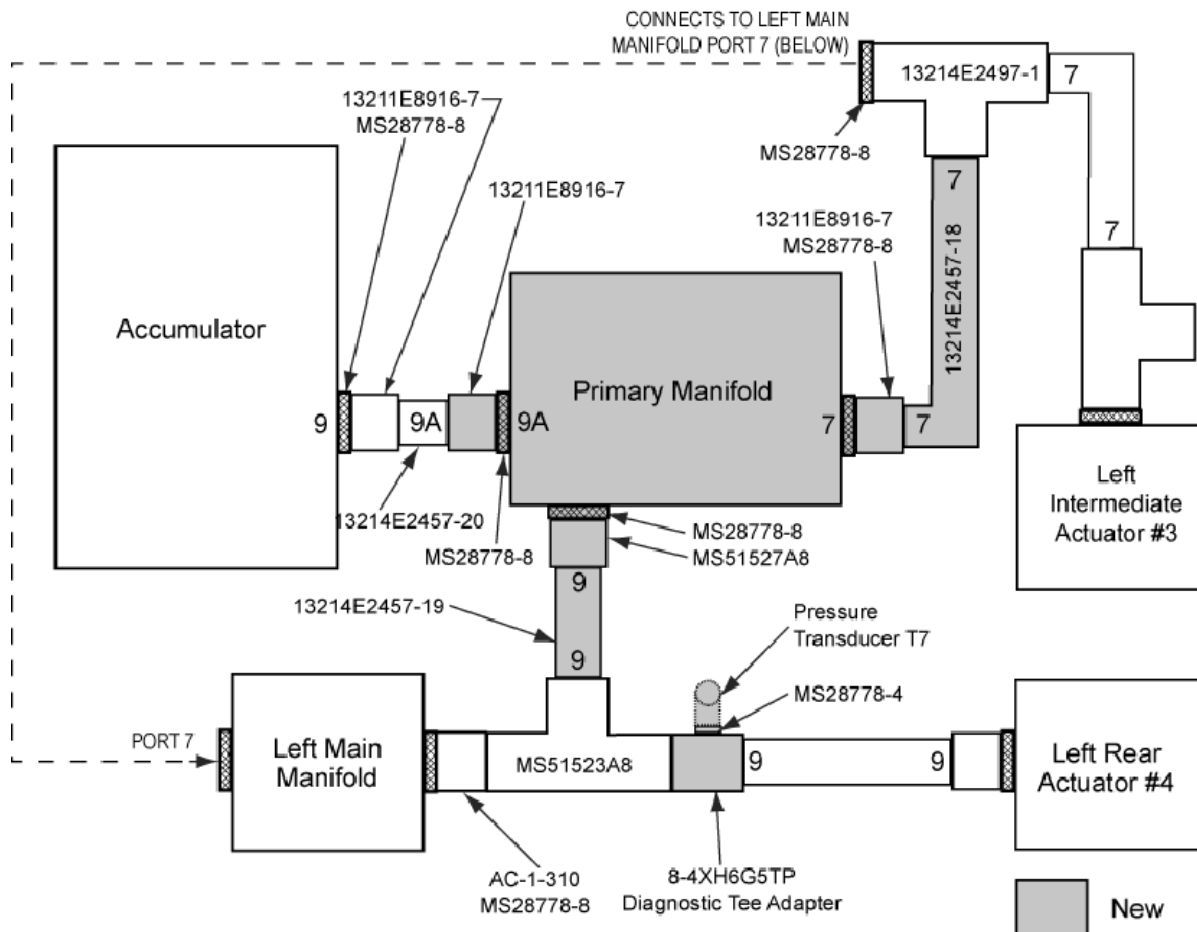

**Figure 3-31. Interconnection of Components After Modification**

## SECTION II INSTALLATION OF HDC PRIMARY MANIFOLD ASSEMBLY, MANUAL SHUT-OFF VALVE V23, AND LEFT MAIN MANIFOLD PRESSURE TRANSDUCER T7 - CONTINUED

### 3-8 CONNECTION OF OTHER HYDRAULIC COMPONENTS TO HDC PRIMARY MANIFOLD ASSEMBLY AND DCV BANK - CONTINUED

#### NOTE

It may be necessary to re-orient some components (that are not modified as part of the HDC installation) to provide good hydraulic connections.

#### NOTE

Steps q through aa apply to Figure 3-32.

- q. Install new hydraulic hose, 13214E2457-19, (2) between port 9 of primary manifold assembly and rear tee on port 9 of left main manifold (rear side). It may be necessary to orient tee connector to approximate five o'clock position (120°) for proper connection.
- r. Retag and install hydraulic hose, 13214E2457-20 (changed from 13214E2457-4) (not visible in Figure 3-32) between port 9A on back (only port on back) of primary manifold assembly and port 9 of main accumulator.
- s. Retag and install hydraulic hose, 13214E2457-21 (changed from 13214E2457-9), (9) between port 17R (bottom) of primary manifold assembly and port 17R of left main manifold (top side).

#### NOTE

Figure 3-33 shows the orientation of the hoses and fittings connected to the circuit 19 and circuit 20 tees behind the left main manifold. The upper portion of Figure 3-33 shows the components before the modification while the lower portion of the figure shows the components after the modification.

#### NOTE

Steps t and u below also apply to Figure 3-33.

- t. Retag and install hydraulic hose, 13214E2457-22 (changed from 13214E2457-10), (4) between port 19 (bottom) of primary manifold assembly and circuit 19 tee (forward). It may be necessary to re-orient the circuit 19 tee parallel to the bottom of the bowl as shown on lower portion of Figure 3-33 to ensure proper connection.
- u. Re-orient circuit 20 tee (rear) such that hydraulic hose from DCV bank control valve 20 (VLV 20) is oriented at approximately a 45° angle from horizontal as shown in lower portion of Figure 3-33. This allows more flexibility in routing and movement of other hydraulic hoses.
- v. Retag and install hydraulic hose, 13214E2457-23 (changed from 13214E2457-11), (5) between port 17L (bottom) of primary manifold assembly and port 17L of left main manifold (top side).

## SECTION II INSTALLATION OF HDC PRIMARY MANIFOLD ASSEMBLY, MANUAL SHUT-OFF VALVE V23, AND LEFT MAIN MANIFOLD PRESSURE TRANSDUCER T7 - CONTINUED

### 3-8 CONNECTION OF OTHER HYDRAULIC COMPONENTS TO HDC PRIMARY MANIFOLD ASSEMBLY AND DCV BANK - CONTINUED

- w. Retag and install hydraulic hose, 13214E2457-24 (changed from 13214E2457-13), (7) between port 3R (bottom) of primary manifold assembly and port 3R of left main manifold (top side).
- x. Retag and install hydraulic hose, 13214E2457-25 (changed from 13214E2457-14), (6) between port 3L (bottom) of primary manifold assembly and port 3L of left main manifold (top side).
- y. Retag and install hydraulic hose, 13214E2478-3 (changed from 13214E2478-2), (8) between port C2 (bottom) of primary manifold assembly and port C2 on winch manifold (rear).
- z. Retag and install hydraulic hose, 13214E2473-3 (changed from 13214E2473-2), (3) between port 21 (bottom) of primary manifold assembly and base of ejector cylinder tube (line 21).
- aa. Re-install any previously removed, unchanged, hydraulic hoses on DCV bank that have not been re-installed.

#### NOTE

The interconnection of primary manifold assembly is not complete at this time. There are additional hoses that are installed on primary manifold assembly when hydraulic filter area of bowl is modified.

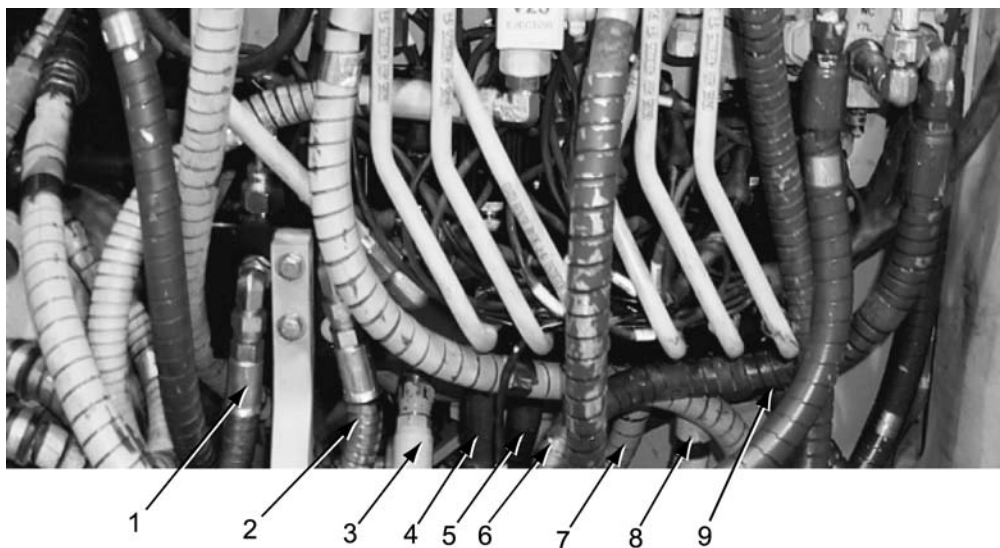

Figure 3-32. HDC Primary Manifold Assembly Hydraulic Interconnection

## SECTION II INSTALLATION OF HDC PRIMARY MANIFOLD ASSEMBLY, MANUAL SHUT-OFF VALVE V23, AND LEFT MAIN MANIFOLD PRESSURE TRANSDUCER T7 - CONTINUED

### 3-8 CONNECTION OF OTHER HYDRAULIC COMPONENTS TO HDC PRIMARY MANIFOLD ASSEMBLY AND DCV BANK - CONTINUED

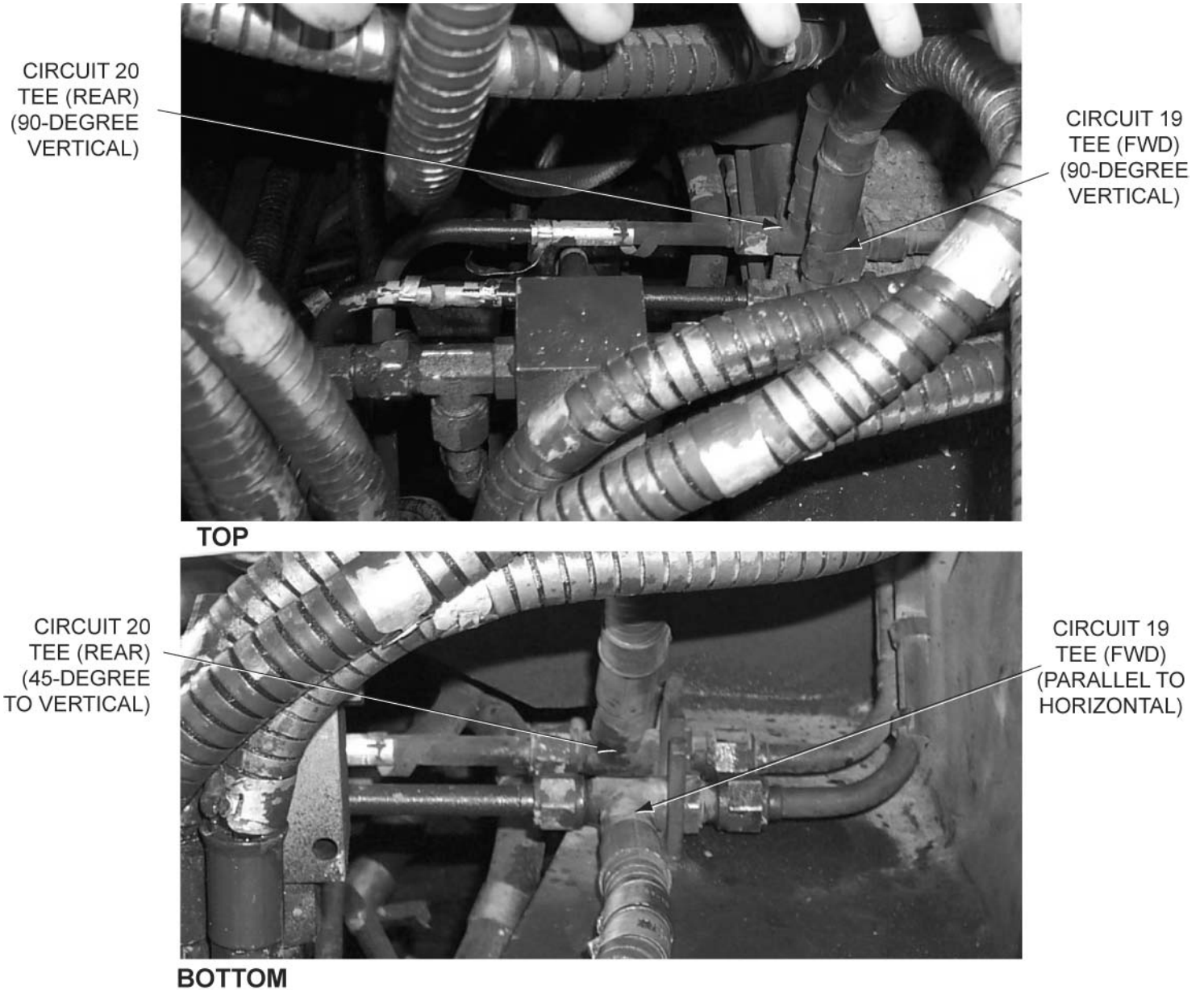

Figure 3-33. Circuit 19 (Forward) and Circuit 20 (Rear) Tee Orientation

## SECTION III MODIFICATION OF MAIN HYDRAULIC FILTER AREA

### 3-9 REMOVAL OF ITEMS TO ACCOMMODATE MODIFICATION

#### NOTE

Steps a through f below apply to Figure 3-34.

#### NOTE

Some vehicles have small L-shaped brackets supporting mounting of high-pressure filters. These brackets must be removed to facilitate modification.

- a. Remove quick-disconnect (QD) hydraulic hoses (9) and (10) from left and right filters. Note that QD fittings are different, and cannot be connected improperly, to ensure proper connections are made during installation.
- b. Remove left (6) and right (1) hydraulic high-pressure main pump filters (housing, head, and bowl), VD-00789-12W1, from filter area of bowl. Refer to TM 5-2350-262-20-2, Hydraulic High Pressure Filter and Element Replacement.
- c. Remove filter guard protective bracket, 12379480, (7) above left and right hydraulic high-pressure filters by removing three locking screws (5) and three flat washers (4). Retain flat washers.
- d. Remove hydraulic hoses (3) and (8) from both filters.
- e. Remove elbow, MS51527A8, (2) and o-ring, MS28778-8, from each high-pressure filter.
- f. Replace filter element, 12273559, in left and right high-pressure filters. Refer to TM 5-2350-262-20-2, Hydraulic High Pressure Filter and Element Replacement.

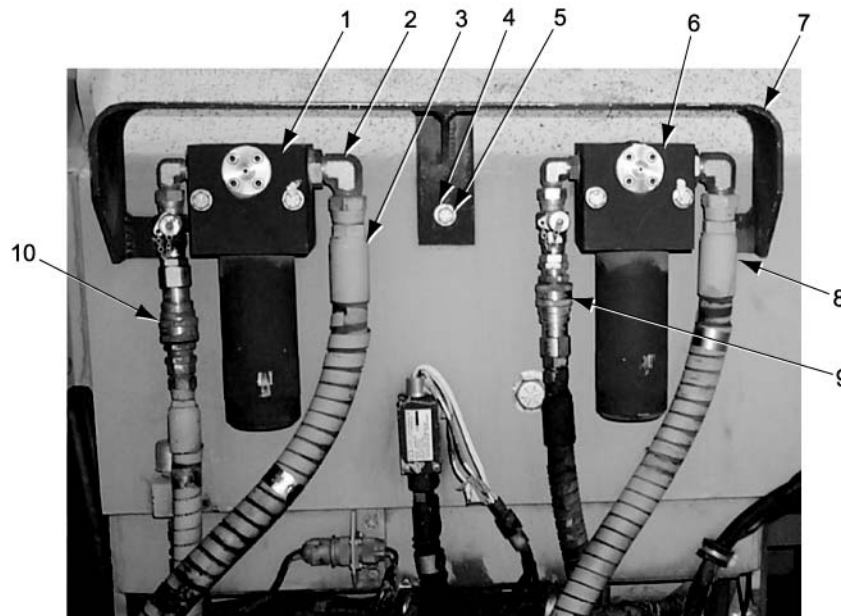

Figure 3-34. Components to be Removed/Relocated in Main Pump Filter Area

## SECTION III MODIFICATION OF MAIN HYDRAULIC FILTER AREA - CONTINUED

### 3-10 MODIFICATIONS TO MAIN PUMP RIGHT HYDRAULIC FILTER AREA – INCLUDING ADDITION OF BALL VALVE V21 AND PRESSURE TRANSDUCER T3

#### NOTE

Steps a through g below apply to Figure 3-35.

#### NOTE

Ball valve V21 requires a configuration change from right-hand operation to left-hand operation prior to installing valve to provide necessary space in filter area for proper operation.

#### NOTE

Do not adjust tension screw on bottom of handle, at any time.

- a. Steps d and e change manual ball valve, BVHP-O8-SSS-1NG, configuration from right hand operation to left hand operation by rotating cam plate 90° counterclockwise (CCW). This manual ball valve is functionally designated as V21.
- b. Visually inspect position of ball valve by looking through valve body (5) to ensure that the valve is open. Ensure valve is open with valve handle (1) in the open position as shown in the top portion of Figure 3-35.
- c. Remove hex head allen screw (2) attaching handle (1) to ball valve, BVHP-O8-SSS-1NG, body (5). Do not adjust or remove tension screw (4) when removing handle (1) from valve body (5).
- d. Remove handle (1) and spacer (3) from ball valve body (5) to expose cam plate (6) and stop pin (7). As supplied, and with handle removed, cam plate (6) is configured as shown in middle portion of Figure 3-35 (right hand operation configuration).
- e. Lift cam plate (6) from ball valve body (5) and rotate cam plate (6) 90° CCW so pin (7) on ball valve body (5), with respect to cam plate, is positioned as shown on lower portion of Figure 3-35 for left hand operation.
- f. Install spacer (3) and handle (1) on ball valve (now configured for left-hand operation).
- g. Install hex head allen screw (2) and tighten to secure handle (1) on valve body (5).



### SECTION III MODIFICATION OF MAIN HYDRAULIC FILTER AREA - CONTINUED

#### 3-10 MODIFICATIONS TO MAIN PUMP RIGHT HYDRAULIC FILTER AREA – INCLUDING ADDITION OF BALL VALVE V21 AND PRESSURE TRANSDUCER T3 – CONTINUED

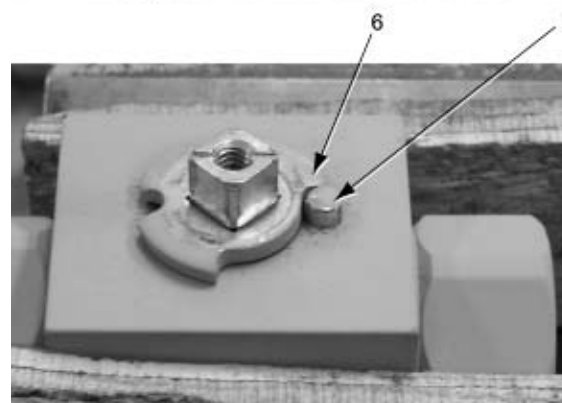
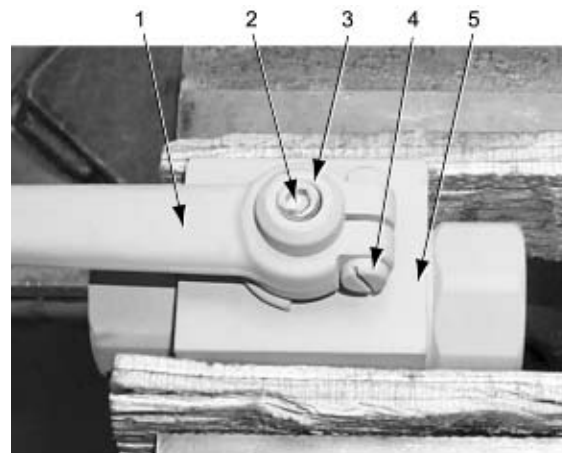

RIGHT HAND CONFIGURATION  
(BEFORE MODIFYING BALL VALVE)

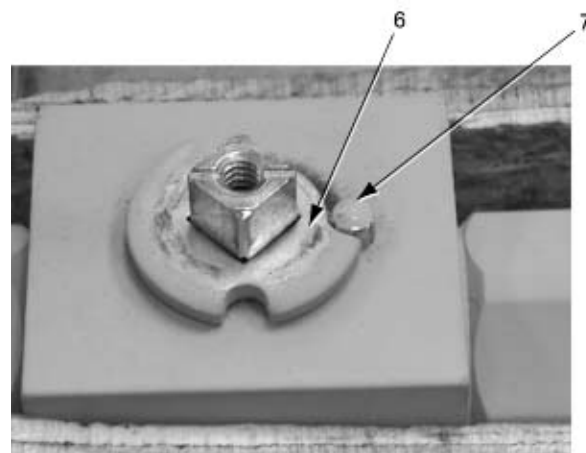

SHOWN IN  
VALVE OPEN  
POSITION  
(HANDLE PARALLEL  
TO VALVE)

LEFT HAND CONFIGURATION  
(AFTER MODIFYING BALL VALVE)

Figure 3-35. Manual Ball Valve Modification, Right Filter Area

## SECTION III MODIFICATION OF MAIN HYDRAULIC FILTER AREA - CONTINUED

### 3-10 MODIFICATIONS TO MAIN PUMP RIGHT HYDRAULIC FILTER AREA – INCLUDING ADDITION OF BALL VALVE V21 AND PRESSURE TRANSDUCER T3 - CONTINUED

#### WARNING

Serious hearing loss and eye injury can occur during drilling and grinding operations. Wear ear and eye protection.

#### NOTE

When drilling mounting holes drill one hole, mount the filter mounting plate, and use the plate as a template for locating the other holes.

#### NOTE

Steps h through j apply to Figure 3-36. Reference should also be made to FO 3-2.

- h. Mark locations for drilling three holes each for both left and right hydraulic high pressure filter mounting plates in front bulkhead in upper portion of bowl area, for front compartment plate modifications. Refer to FO 3-1. It may be desirable to place tape over area where holes will be drilled to make it easier to mark location.
- i. Drill and tap three holes for each main hydraulic filter mounting plate using 33/64" drill bit and 9/16" -12 tap. Drill holes to a depth of 3/4" (19.05). Ensure all warnings are heeded during drilling.
- j. Install insert, MS51831-104, in each hole in front bulkhead for two hydraulic filter mounting plates, 12496966, (three inserts for each mounting plate) and in three holes for new mounting location for filter guard. Refer to FO 3-2 and to Figure 3-36.

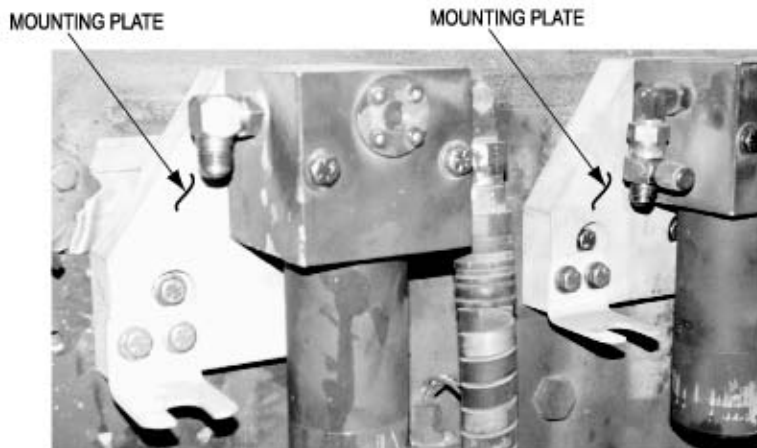

Figure 3-36. Hydraulic Filter Mounting Plates Shown Installed

#### NOTE

The main pump hydraulic filter assemblies are modified and loosely assembled prior to installation in the bowl filter area. Individual filter assembly components are tightened after installation on mounting plates in the bowl.

## SECTION III MODIFICATION OF MAIN HYDRAULIC FILTER AREA - CONTINUED

### 3-10 MODIFICATIONS TO MAIN PUMP RIGHT HYDRAULIC FILTER AREA – INCLUDING ADDITION OF BALL VALVE V21 AND PRESSURE TRANSDUCER T3 - CONTINUED

#### NOTE

Steps k through ab below apply to Figure 3-37.

- k. Install adapter, 8F650X-SS, (2) and o-ring, MS28778-8, (3) on hydraulic filter head (4).
- l. Install swivel nut tee, MS51523B8, (31) on adapter (2) mounted on hydraulic filter head (4).
- m. Install another adapter, 8F650X-SS, (30) and o-ring, MS28778-8, (29) on top of manual ball valve, BVHP-08-SSS-1NG, (28).
- n. Install manual ball valve (28) on lower end of swivel nut tee (31).
- o. Install bulkhead adapter, 8WF50X-SS, (27) and o-ring, MS28778-8, (26) in bottom of manual ball valve (28).
- p. Place two flat washers, 10910174-8, (25) loosely on bulkhead adapter (27).
- q. Thread jam nut, MS51860-56Z, (24) loosely onto end of bulkhead adapter (27) to hold two flat washers (25) in position. Do not tighten jam nut at this time.
- r. Install swivel adapter, 8F650X-SS, (8) and o-ring, MS28778-8, (9) on top of pressure relief valve (21).

### SECTION III MODIFICATION OF MAIN HYDRAULIC FILTER AREA - CONTINUED

#### 3-10 MODIFICATIONS TO MAIN PUMP RIGHT HYDRAULIC FILTER AREA – INCLUDING ADDITION OF BALL VALVE V21 AND PRESSURE TRANSDUCER T3 – CONTINUED

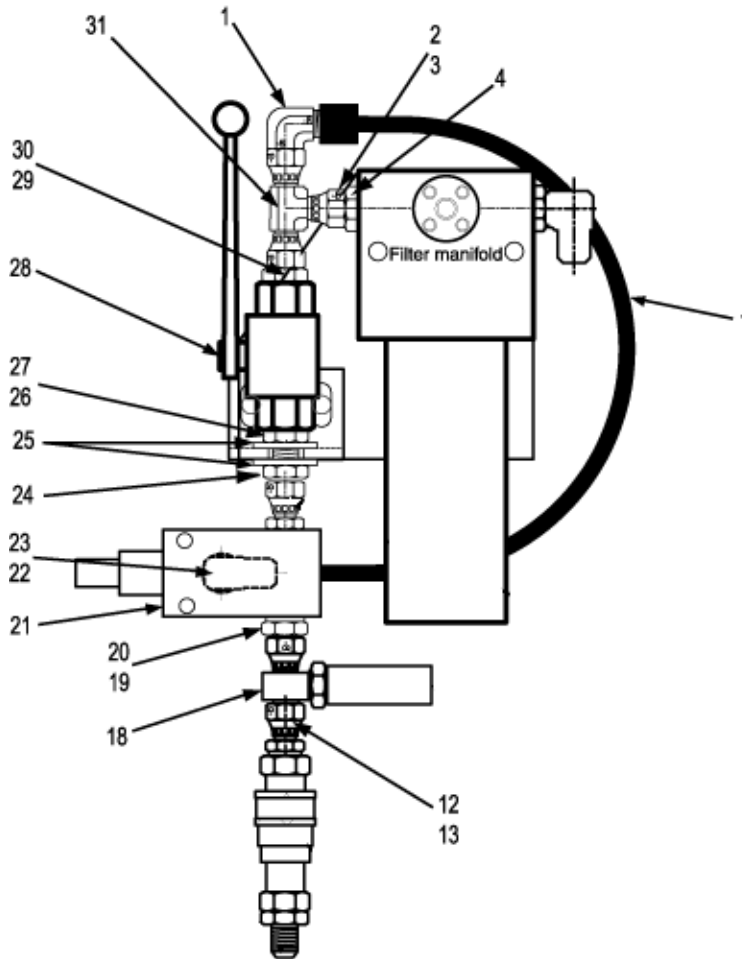

Figure 3-37. Modifications to Main Pump Right Hydraulic Filter Area (Left Side Shown)

## **SECTION III MODIFICATION OF MAIN HYDRAULIC FILTER AREA - CONTINUED**

### **3-10 MODIFICATIONS TO MAIN PUMP RIGHT HYDRAULIC FILTER AREA – INCLUDING ADDITION OF BALL VALVE V21 AND PRESSURE TRANSDUCER T3 - CONTINUED**

- s. Attach pressure relief valve, 1A30-01-V-8T1-D-430, (21) (relocated from behind left main manifold and now set to 4300 psi (29647.46 kilopascal)) to bottom of manual ball valve (28). Ensure that pressure relief valve has been set to 4300 PSI (29647.46 kilopascal).
- t. Install 90-degree adapter, 13211E9018-12, (23) and o-ring, MS28778-8, (22) on front face of relief valve (21).
- u. At top of filter assembly, install union elbow, 8-6 ETX-S, (1) on top port of swivel nut tee (31).
- v. Install adapter, 8F650X-SS, (20) and o-ring, MS28778-8, (19) on bottom port of pressure relief valve (21).
- w. Install diagnostic tee adapter, 8-4XHX6G5TP, (18) on adapter, 8F650X-SS, (20).
- x. Install pressure transducer, 12496923, (10) and o-ring, MS28778-4, (11) on diagnostic tee adapter (18). This pressure transducer has been functionally designated as T3.
- y. Install saved adapter, 8F650X-SS, (12) and o-ring, MS28778-8, (13) on bottom of diagnostic tee adapter (18).
- z. Install (previously removed) male/female quick-disconnect (QD) fitting (14) and o-ring, MS28778-4, (15), noting difference in male/female QD connections for left and right filter assemblies.
- aa. Place "V21 MAIN PUMP" label, 12496928-1, on flat portion (to the right of handle) of ball valve (28).
- ab. Connect new hydraulic relief bypass hose, 13214E2501-12, (7) between port T 13R of pressure relief valve (21) and union elbow (1) (connected through swivel nut tee (31)) connected to inlet port 13R of filter manifold.

## SECTION III MODIFICATION OF MAIN HYDRAULIC FILTER AREA - CONTINUED

### 3-11 MODIFICATIONS TO MAIN PUMP LEFT HYDRAULIC FILTER AREA – INCLUDING ADDITION OF BALL VALVE V22 AND PRESSURE TRANSDUCERS T4

#### NOTE

Modifications to main pump left hydraulic filter area are same as modifications to main pump right hydraulic filter area except for identification markers of ball valves and pressure transducers. In addition, pressure relief valve used with manual ball valve V22 is a new valve. References in this paragraph are to same figures as for ball valve V21 as described in paragraph 3-10, with exceptions as noted.

#### NOTE

Steps a through g below apply to Figure 3-38.

#### NOTE

Ball valve V22 requires a configuration change from right-hand operation to left-hand operation prior to installing valve to provide necessary space in filter area for proper operation.

#### NOTE

Do not adjust tension screw on bottom of handle at any time.

- a. Steps d and e change manual ball valve, BVHP-08-SSS-1NG, configuration from right-hand operation to left-hand operation by rotating cam plate 90° CCW. This manual ball valve is functionally designated as V22.
- b. Visually inspect position of ball valve by looking through valve body (5) to ensure that the valve is open. Ensure valve is open with valve handle (1) in the open position as shown in the top portion of Figure 3-38.
- c. Remove hex head allen screw (2), attaching handle (1) to ball valve, BVHP-08-SSS-1NG, body (5). Do not adjust or remove tension screw (4) when removing handle (1) from valve body (5).
- d. Remove handle (1) and spacer (3) from ball valve body (5) to expose cam plate (6) and stop pin (7). As supplied, and with handle removed, cam plate (6) is configured as shown in middle portion of Figure 3-38 (right hand operation configuration).
- e. Lift cam plate (6) from ball valve body (5) and rotate cam plate (6) 90° CCW so pin (7) on ball valve body (5), with respect to cam plate, is positioned as shown on lower portion of Figure 3-38 for left hand operation.
- f. Install spacer (3) and handle (1) on ball valve (now configured for left-hand operation).
- g. Install hex head allen screw (2) and tighten to secure handle (1) on valve body (5).

### SECTION III MODIFICATION OF MAIN HYDRAULIC FILTER AREA - CONTINUED

#### 3-11 MODIFICATIONS TO MAIN PUMP LEFT HYDRAULIC FILTER AREA – INCLUDING ADDITION OF BALL VALVE V22 AND PRESSURE TRANSDUCERS T4 - CONTINUED

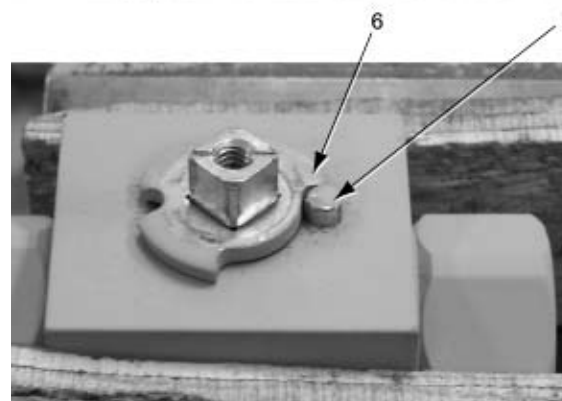
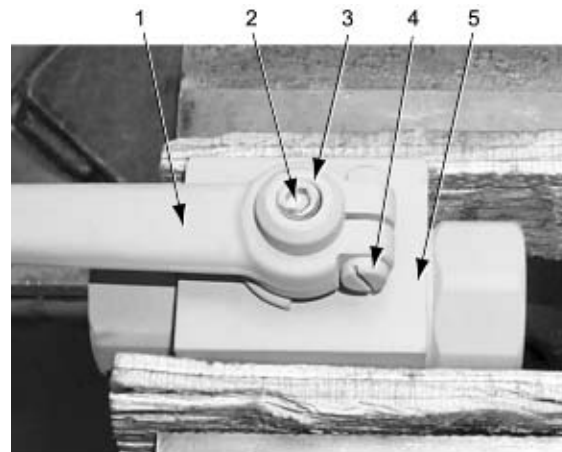

RIGHT HAND CONFIGURATION  
(BEFORE MODIFYING BALL VALVE)

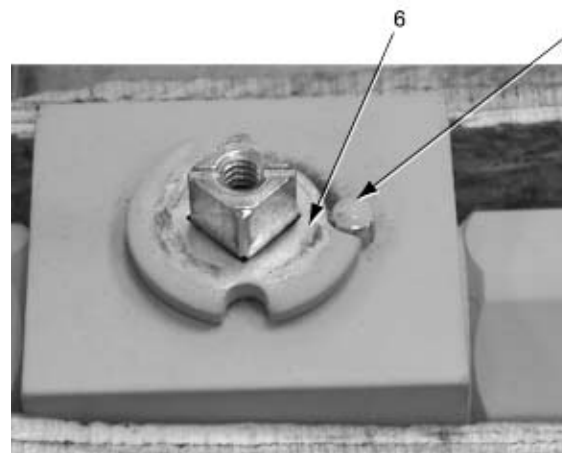

SHOWN IN  
VALVE OPEN  
POSITION  
(HANDLE PARALLEL  
TO VALVE)

LEFT HAND CONFIGURATION  
(AFTER MODIFYING BALL VALVE)

Figure 3-38. Manual Ball Valve Modification, Left Filter Area

## SECTION III MODIFICATION OF MAIN HYDRAULIC FILTER AREA - CONTINUED

### 3-11 MODIFICATIONS TO MAIN PUMP LEFT HYDRAULIC FILTER AREA – INCLUDING ADDITION OF BALL VALVE V22 AND PRESSURE TRANSDUCERS T4 - CONTINUED

#### NOTE

The modified main pump hydraulic filter assemblies are loosely assembled prior to installation in the bowl filter area. Individual filter assembly components are tightened after installation on mounting plates in the bowl.

#### NOTE

Steps h through y below apply to Figure 3-39.

- h. Install adapter, 8F650X-SS, (2) and o-ring, MS28778-8, (3) on hydraulic filter head (4).
- i. Install swivel nut tee, MS51523B8, (31) on adapter (2) mounted on hydraulic filter head (4).
- j. Install adapter, 8F650X-SS, (30) and o-ring, MS28778-8, (29) on top of manual ball valve BVHP-08-SSS-1NG (28).
- k. Install manual ball valve (28) on lower end of swivel nut tee (31).
- l. Install bulkhead adapter, 8WF50X-SS, (27) and o-ring, MS28778-8, (26) in bottom of manual ball valve (28).
- m. Place two flat washers, 10910174-8, (25) loosely on bulkhead adapter (27).
- n. Thread jam nut, MS51860-56Z, (24) loosely onto end of bulkhead adapter (27) to hold two flat washers (25) in position. Do not tighten jam nut at this time.
- o. Install swivel adapter, 8F650X-SS, (8) and o-ring, MS28778-8, (9) on top of pressure relief valve (21).
- p. Attach new pressure relief valve, 1A30-01-V-8ST1-D-430, (21) set to 4300 psi (29647.46 kilopascal) to bottom of manual ball valve (28).
- q. Install 90-degree adapter, 13211E9018-12, (23) and o-ring, MS28778-8, (22) on front face of new relief valve (21).
- r. At top of filter assembly, install union elbow, 8-6-ETXS, (1) on top port of swivel nut tee (31).
- s. Install adapter, 8F650X-SS, (20) and o-ring, MS28778-8, (19) on new relief valve (21).
- t. Install diagnostic tee adapter, 8-4XHX6G5TP, (18) on adapter 8F650X-SS (20).
- u. Install pressure transducer, 12496923, (10) and o-ring, MS28778-4, (11) on diagnostic tee adapter (18). This pressure transducer is functionally designated as T4.
- v. Install saved adapter, 8F650X-SS, (12), and o-ring, MS28778-8, (13) on bottom of diagnostic tee adapter (18).



**SECTION III MODIFICATION OF MAIN HYDRAULIC FILTER AREA  
- CONTINUED**

**3-11 MODIFICATIONS TO MAIN PUMP LEFT HYDRAULIC FILTER AREA – INCLUDING  
ADDITION OF BALL VALVE V22 AND PRESSURE TRANSDUCERS T4 –  
CONTINUED**

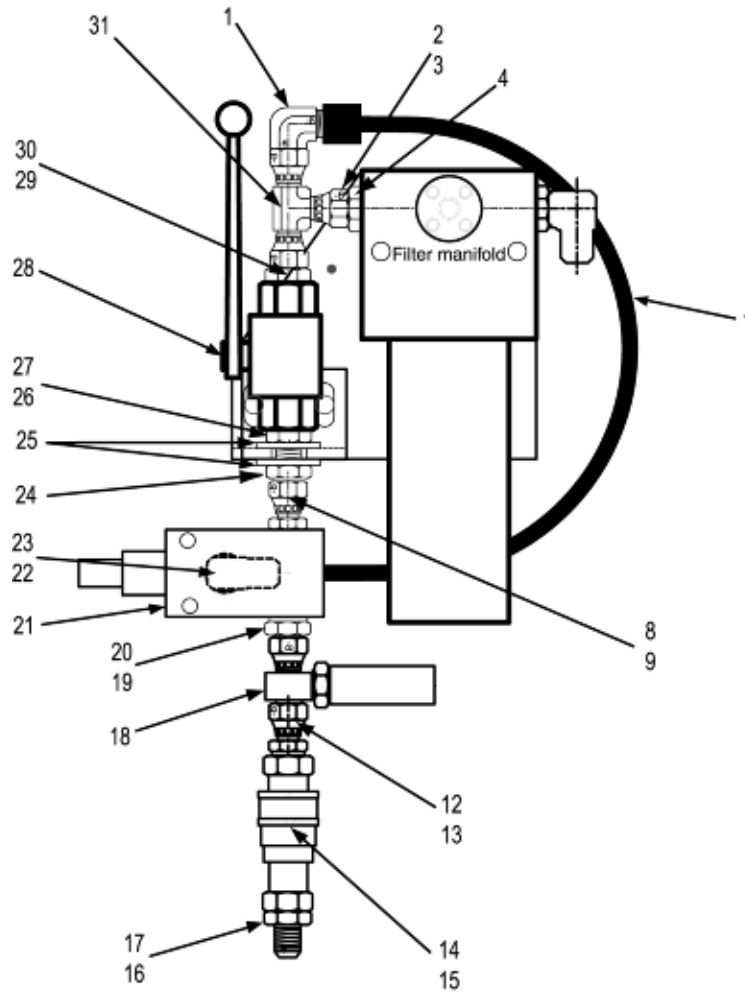

**Figure 3-39. Modifications to Main Pump Left Hydraulic Filter Area**

## **SECTION III MODIFICATION OF MAIN HYDRAULIC FILTER AREA - CONTINUED**

### **3-11 MODIFICATIONS TO MAIN PUMP LEFT HYDRAULIC FILTER AREA – INCLUDING ADDITION OF BALL VALVE V22 AND PRESSURE TRANSDUCERS T4 - CONTINUED**

- w. Install correct (previously removed) male/female quick-disconnect (QD) fitting (14) and o-ring, MS28778-4, (15), noting difference in male/female QD connections for left and right filter assemblies.
- x. Place “V22 MAIN PUMP” label, 12496928-2, on flat portion (to the right of handle) of ball valve V22 (28).
- y. Connect new hydraulic relief bypass hose, 13214E2501-12, (7) between port T 13L of new pressure relief valve (21) and union elbow (1) (connected through swivel nut tee (31)) connected to inlet port 13L of filter manifold.

### **3-12 INSTALLATION OF MODIFIED MAIN PUMP HYDRAULIC FILTER ASSEMBLIES**

#### **NOTE**

Steps a through j apply to Figure 3-40.

- a. Reinstall hydraulic filter guard, 12379480, in new location in bowl compartment front bulkhead using three new locking screws, B1821BH038C100L, and three previously removed flat washers (MS27183-14).
- b. Using three locking screws, B1821BH038C150L, (4) and three flat washers, 10910174-3, (5) for each plate (6), install left and right hydraulic filter mounting plates (6) on bowl compartment front bulkhead.
- c. Install one ball valve support bracket, 12496967, (1) on each filter mounting plate (6) with two locking screws, B1821BH038C100L, (2) and two flat washers, MS27183-14, (3). Do not tighten screws at this time.
- d. Position modified filter assembly over ball valve support bracket (1) with bracket positioned between two loosely installed flat washers (3).
- e. Install modified left (8) and right (7) hydraulic high-pressure filter assemblies on mounting plates (6) in main filter portion of bowl area per TM 5-2350-262-20-2, Hydraulic High-Pressure Filter and Element Replacement.

#### **NOTE**

Step f applies to Figure 3-41.

- f. Push hydraulic fittings fully back, into the mounting slot in support bracket.
- g. Loosen and re-tighten hydraulic fittings as required.
- h. Tighten jam nut on bulkhead fitting.
- i. Tighten mounting screws to secure support bracket.
- j. Connect previously removed hydraulic hoses to modified filter assemblies per TM 5-2350-262-20-2, Hydraulic High-Pressure Filter and Element Replacement.

### SECTION III MODIFICATION OF MAIN HYDRAULIC FILTER AREA - CONTINUED

#### 3-12 INSTALLATION OF MODIFIED MAIN PUMP HYDRAULIC FILTER ASSEMBLIES - CONTINUED

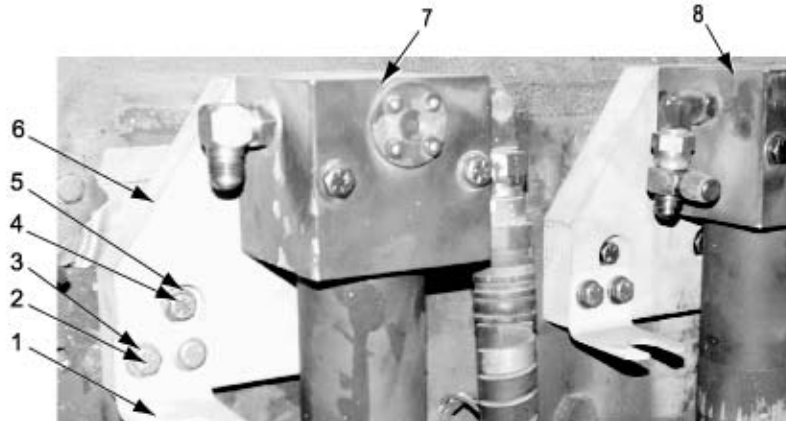

Figure 3-40. Modification to Main Pump Hydraulic Filter Area



Figure 3-41. Valve Components Shown Installed in Support Bracket

### SECTION III MODIFICATION OF MAIN HYDRAULIC FILTER AREA - CONTINUED

#### 3-12 INSTALLATION OF MODIFIED MAIN PUMP HYDRAULIC FILTER ASSEMBLIES - CONTINUED

##### NOTE

Step k below applies to Figure 3-42.

- k. When modification to filter area is complete and all modified filter assembly components have been installed and interconnected, the main pump filter area of the upper bowl will be configured as shown in Figure 3-42.

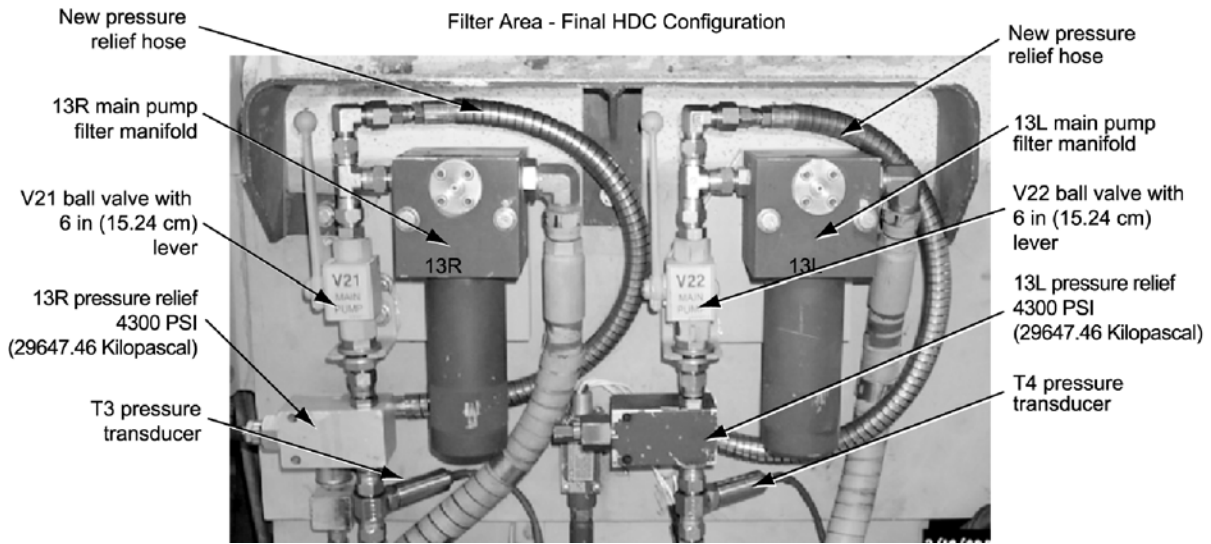

Figure 3-42. Installation of Modified Main Pump Hydraulic Filter Assemblies

## SECTION IV INSTALLATION OF PRESSURE TRANSDUCER T12

### NOTE

Steps a through e below apply to Figure 3-43.

- a. Trace line 11 hydraulic hose (1) from bottom of pressure switch (located between two modified hydraulic filter assemblies in upper portion of bowl area) to suspension sprung/unsprung valve (5) next to DCV bank (2).
- b. Disconnect end of line 11 hose (1) attached to suspension sprung/unsprung valve (5).
- c. Attach diagnostic tee adapter, 8-4XH6G5TP, (6) to port (line 11) on suspension valve (5).
- d. Attach pressure transducer, 12496923, (3) and o-ring, MS28778-4, (4) to 90-degree port of diagnostic tee adapter (6). This pressure transducer has been functionally designated as T12.
- e. Connect line 11 hydraulic hose (1) (previously removed from suspension valve in step b) to in-line port of diagnostic tee adapter (6).

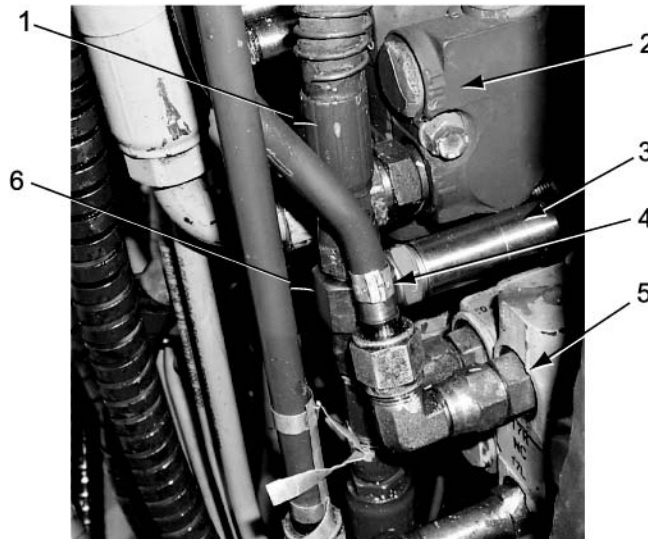

Figure 3-43. Installation of Pressure Transducer T12

## SECTION V MODIFICATION OF ACCESS COVER

### WARNING

Make sure sharp edges and burrs are removed after modifying access cover. Serious injury could result if finished surfaces are not smooth.

### NOTE

Steps a through c apply to Figures 3-44 and 3-45.

- a. Remove three self-locking bolts (3), three flat washers (2), and access cover, 12332229, (1) from right side of bowl area as shown in Figure 3-44. Discard self-locking bolts but retain flat washers. Refer to TM 5-2350-262-20-1, Hull Access Covers and Plug Replacement and Repair procedure.

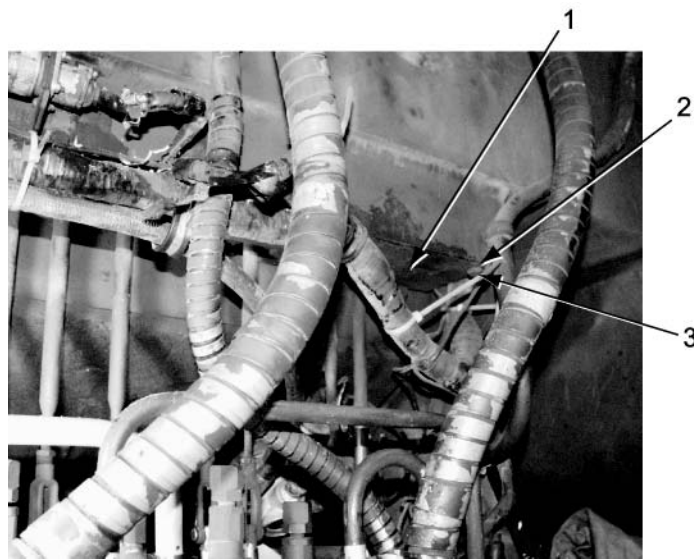

Figure 3-44. Location of Access Cover

## SECTION V MODIFICATION OF ACCESS COVER - CONTINUED

- b. Modify access cover (1) by removing 1" (25.4 mm) portion on end of cover as shown on Figure 3-45.
- c. Do not reinstall access cover at this time.

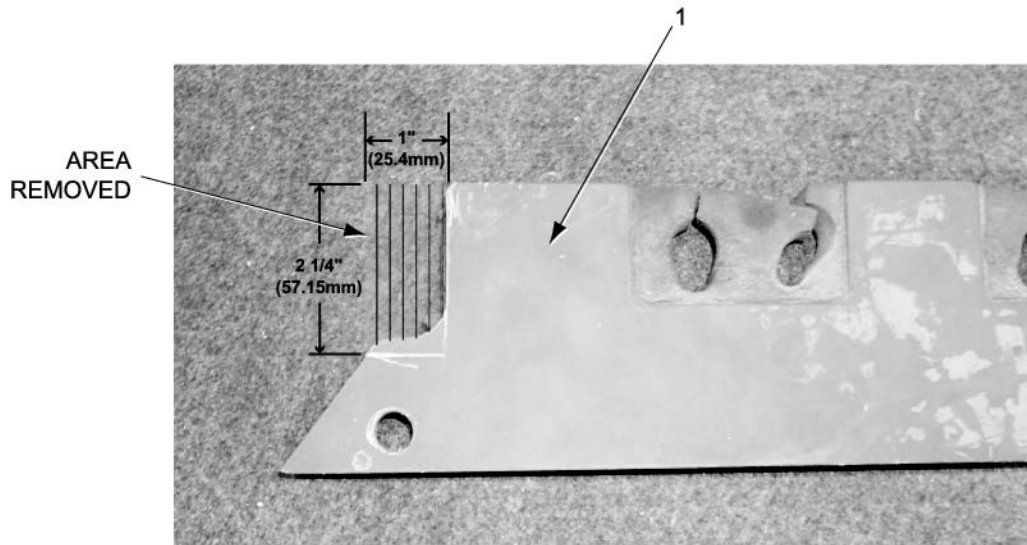

Figure 3-45. Modification to Access Cover

## SECTION VI INSTALLATION OF BUMP STOP CYLINDERS PRESSURE TRANSDUCERS T8 AND T9

### 3-13 INSTALLATION OF RIGHT SIDE BUMP STOP CYLINDER PRESSURE TRANSDUCER T8

#### NOTE

Steps a through e below apply to Figure 3-46.

- a. Remove and retain four screws from actuator right access plate in ejector bowl and remove actuator access plate from frame per TM 5-2350-262-20-1, Actuator Access Plates Replacement.
- b. Remove circuit 9 hose (larger diameter hose, -6 hose) (2) from bulkhead fitting on aft side of plate. Do not remove circuit 11 hose.
- c. Install diagnostic tee adapter, 6-4XHX6G5TP, (1) on circuit -9 fitting on aft side of bulkhead plate.
- d. Install pressure transducer, 12496923, (3) and o-ring, MS28778-4, (4) on far side connection on diagnostic tee adapter (1) with transducer positioned as shown. This pressure transducer has been functionally designated as T8.
- e. Reconnect circuit 9 hose from right forward manifold to in-line (straight) side of diagnostic tee adapter (1) on aft side of bulkhead plate.



Figure 3-46. Installation of Right Side Bump Stop Cylinder Pressure Transducer T8



## SECTION VI INSTALLATION OF BUMP STOP CYLINDERS PRESSURE TRANSDUCERS T8 AND T9 - CONTINUED

### 3-14 INSTALLATION OF LEFT SIDE BUMP STOP CYLINDER PRESSURE TRANSDUCER T9

#### NOTE

Steps a through e below apply to Figure 3-47.

- a. Remove and retain four screws from left actuator access plate in ejector bowl and remove actuator access plate from frame per TM 5-2350-262-20-1, Actuator Access Plates Replacement.
- b. Remove circuit 9 hose (larger diameter hose, -6 hose) (1) from bulkhead fitting on aft side of plate. Do not remove circuit 11 hose.
- c. Install diagnostic tee adapter, 6-4XHX6G5TP, (2) on circuit -9 fitting on aft side of bulkhead plate.
- d. Install pressure transducer, 12496923, (4) and o-ring, MS28778-4, (3) on far side connection on diagnostic tee adapter (2) with transducer positioned as shown. This pressure transducer has been functionally designated as T9.
- e. Reconnect circuit 9 hose from right forward manifold to in-line (straight) side of diagnostic tee adapter (2) on aft side of bulkhead plate.

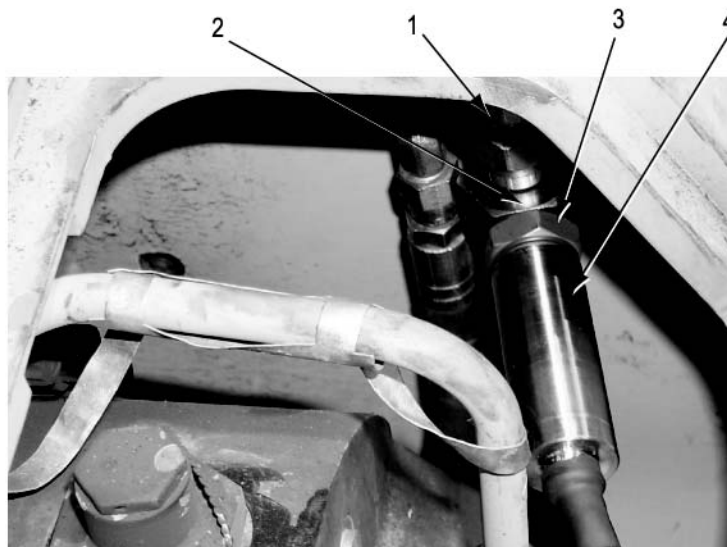

Figure 3-47. Installation of Left Side Bump Stop Cylinder Pressure Transducer T9

## SECTION VII INSTALLATION OF FORWARD ACTUATORS PRESSURE TRANSDUCERS T5 AND T6

### 3-15 INSTALLATION OF FORWARD RIGHT ACTUATOR #1 PRESSURE TRANSDUCER T5

#### NOTE

Steps a and f below apply to Figure 3-48.

#### NOTE

Area where pressure transducer T5 will be installed can be accessed from bowl area and from underneath vehicle. It is recommended that installation be accomplished from most convenient position.

- a. Access port 3 (6) of forward right rotary actuator #1 (1).
- b. Tag and disconnect hydraulic hose (4) connected to port 3 (6) of forward right rotary actuator #1 (1). The other end of this hydraulic hose connects to Port 3R of right forward manifold.
- c. Attach diagnostic tee adapter, 8-4XH6G5TP, (5) to port 3 of forward right rotary actuator #1.
- d. Attach pressure transducer, 12496923, (2) and o-ring, MS28778-4, (3) to 90-degree port of diagnostic tee adapter (5). This pressure transducer has been functionally designated as T5.
- e. Connect hydraulic hose removed in step b above to in-line port of diagnostic tee adapter (5) attached to port 3 of forward right rotary actuator #1.
- f. Reinstall actuator right access plate in ejector bowl using four saved machine bolts per TM 5-2350-262-20-1, Actuator Access Plates Replacement, or leave off for installation of electrical wiring harness in Chapter 5.

PRESSURE TRANSDUCER T8  
(REFERENCE)

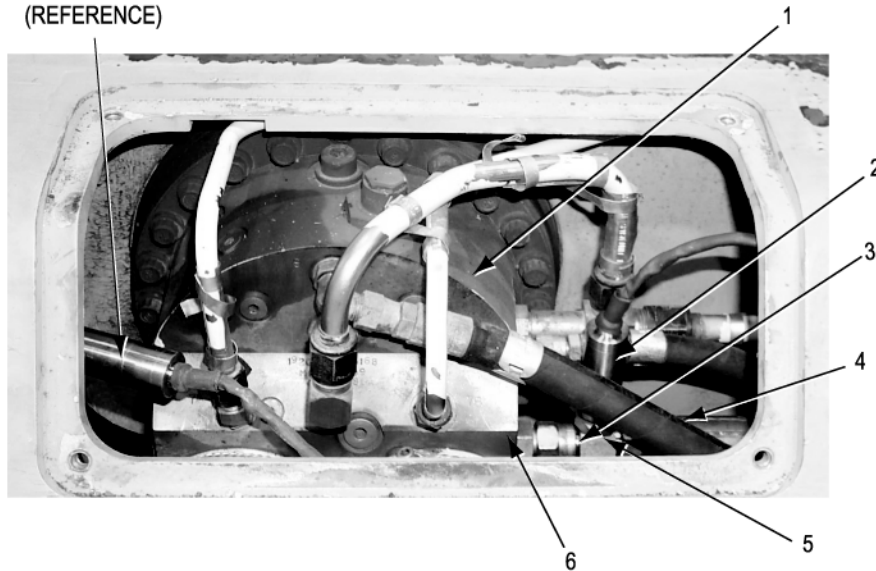

Figure 3-48. Installation of Pressure Transducer T5

## SECTION VII INSTALLATION OF FORWARD ACTUATORS PRESSURE TRANSDUCERS T5 AND T6 - CONTINUED

### 3-16 INSTALLATION OF FORWARD LEFT ACTUATOR #1 PRESSURE TRANSDUCER T6

#### NOTE

Steps a through f below apply to Figure 3-49.

#### NOTE

Area where pressure transducer T6 will be installed can be accessed from bowl area and from underneath vehicle. It is recommended that installation be accomplished from most convenient position.

- a. Access port 3 (2) of forward left rotary actuator #1 (1).
- b. Tag and disconnect hydraulic hose (4) connected to port 3 of forward left rotary actuator #1. The other end of hydraulic hose connects to port 3L of left forward manifold.
- c. Attach diagnostic tee adapter, 8-4XH6G5TP, (3) to port 3 of forward left rotary actuator #1.
- d. Attach pressure transducer, 12496923, (6) and o-ring, MS28778-4, (5) to 90-degree port of diagnostic tee adapter (3). This pressure transducer has been functionally designated as T6.
- e. Connect hydraulic hose removed in step b above to in-line port of diagnostic tee adapter (3) attached to port 3 of forward left actuator #1.
- f. Reinstall actuator left access plate in ejector bowl using four saved machine bolts per TM 5-2350-262-20-1, Actuator Access Plates Replacement, or leave off for installation of electrical wiring harness in Chapter 5.

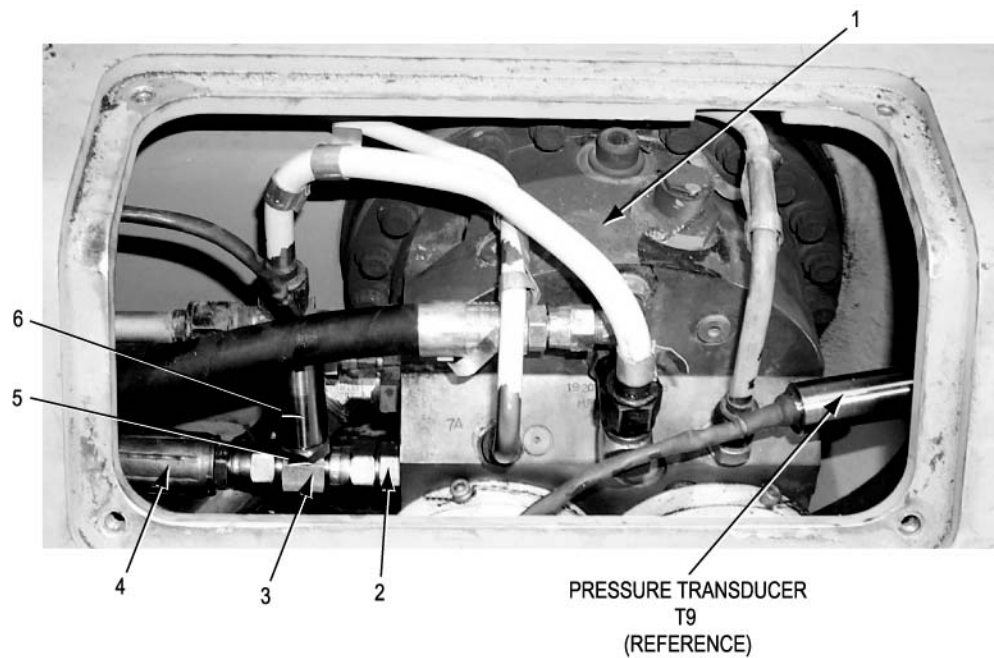

Figure 3-49. Installation of Pressure Transducer T6



## CHAPTER 4 MODIFICATIONS TO UNDERSIDE OF VEHICLE

**SUBJECT:** Major modifications to the underside of vehicle include replacing two existing forward manifolds (left and right) with two new forward manifolds and adding an aft manifold.

**DATE:** 29 August 2008

**DESCRIPTION:** The existing forward left manifold assembly and forward right manifold assembly are replaced with new forward manifold assemblies that perform the same functions as the existing manifold assemblies. The new forward left and forward right manifolds are mounted in the same places as the existing manifolds.

A new aft manifold is connected between left rotary actuator #3 and rear left rotary actuator #4. The aft manifold contains five solenoid valves for controlling hydraulic fluid flow between the two actuators when troubleshooting the hydraulic system.

**TM REFERENCES:** The technical manual references in this procedure are for:

TM 5-2350-262-10, dated June 1992, with Change 7, dated June 2007

TM 5-2350-262-20-1, dated January 1997, with Change 4, dated July 2007

TM 5-2350-262-20-2, dated January 1997, with Change 4, dated July 2007

## SECTION I PREPARATION FOR MODIFICATION

### WARNING

High pressure is present in the M9 hydraulic system. Do not disconnect any hydraulic system component unless hydraulic system pressure has been relieved. Ensure each of the hydraulic control levers is moved several times through all positions and the hydraulic tank dipstick is slowly loosened to relieve pressure. After hydraulic pressure has been relieved, wait at least four (4) minutes before disconnecting any hose or fitting. Failure to comply may result in severe injury to personnel.

### WARNING

Do not work under vehicle unless hull is blocked and apron lockpins are installed. Failure to comply may result in severe injury or death to personnel.

### CAUTION

All exposed electrical contacts and connectors should be capped, protected, or sealed to prevent damage.

### CAUTION

Cap or plug all oil ports and ends of hoses and tubes when oil hoses or tubes are disconnected or removed to prevent contamination. Failure to comply may result in damage to equipment.

### NOTE

Drain oil and collect into suitable containers when hoses and tubes are disconnected or removed.

### NOTE

Schematic diagrams for the M9 ACE vehicle hydraulic system for both the unmodified vehicle and the HDC modified vehicle are included on FO 3-1, 1 of 3 through 3 of 3 for reference, as necessary.

### NOTE

As applicable throughout these procedures, remove and discard old band markers and install new band markers as appropriate, in accordance with underside band marker kit, 12496969.

### NOTE

Use teflon tape when connecting straight pipe fittings.

## **SECTION I PREPARATION FOR MODIFICATION - CONTINUED**

- a. If not previously accomplished, raise and lock apron in full-up (full-open) position per TM 5-2350-262-10.
- b. If not previously accomplished, relieve hydraulic pressure in vehicle per TM 5-2350-262-10, Relieving Hydraulic Pressure.
- c. If not previously accomplished, disconnect vehicle battery power per TM 5-2350-262-20-1, Battery Cable Replacement, Negative Cables Disconnect.
- d. If not previously accomplished, remove four hull access covers on bottom of hull per TM 5-2350-262-20-1, Hull Access Covers and Plug Replacement and Repair.

## SECTION II INSTALLATION OF NEW FORWARD LEFT MANIFOLD ASSEMBLY

### 4-1 REMOVAL OF EXISTING FORWARD LEFT MANIFOLD ASSEMBLY

#### NOTE

Steps a and b below apply to Figure 4-1.

- a. Identify and tag all hoses connected to forward left manifold.
- b. Remove existing forward left manifold per TM 5-2350-262-20-2, Hydraulic Front Manifolds and Fitting Replacement. Discard two locking screws. Note orientation of ports 9, 3L, and 11 on front of manifold.

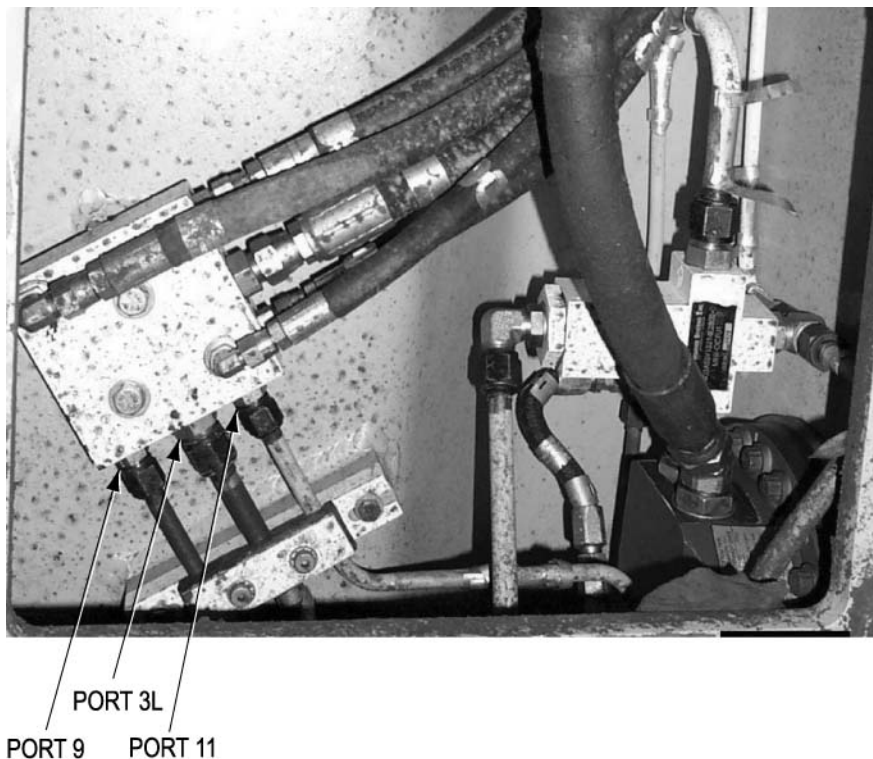

Figure 4-1. Existing Forward Left Manifold Assembly (Being Replaced)



## **SECTION II INSTALLATION OF NEW FORWARD LEFT MANIFOLD ASSEMBLY - CONTINUED**

### **4-2 ASSEMBLY OF NEW FORWARD LEFT MANIFOLD**

#### **CAUTION**

Assembly should be performed in a clean environment and protective dust covers or caps should be installed on all openings to prevent contamination. Dirt can damage parts and cause malfunctions.

#### **CAUTION**

When securing aft manifold in vice, exercise extreme care not to mar any surfaces or damage components.

#### **CAUTION**

Do not over torque. Failure to comply may result in damage to equipment.

#### **NOTE**

Steps a through d applies to Figure 4-2.

#### **NOTE**

A vice must be used to secure the primary manifold during assembly.

#### **NOTE**

Refer to Section I, Table 1-5, Forward Left Manifold Parts List, for required parts.

## SECTION II INSTALLATION OF NEW FORWARD LEFT MANIFOLD ASSEMBLY - CONTINUED

### 4-2 ASSEMBLY OF NEW FORWARD LEFT MANIFOLD - CONTINUED

- a. Install two new o-rings, MS28778-8, (9), straight adapter, AC-1-310, (1), and 45° adapter, 13211E8916-1, (10) on manifold (4). Torque adapters to 40-43 ft/lbs (54.23-58.30 N•m).
- b. Install four new o-rings, MS28778-6, (3), two straight adapters, MS51525A6, (2), 90° adapter, MS51527A6, (5), and 45° adapter, 13211E8916-6, (8) on manifold (4). Torque adapters to 22-24 ft/lbs (29.82-32.53 N•m).
- c. Install three new o-rings, MS28778-4, (6), two 90° adapter, MS51527A4, (7), and pressure transducer, 12496923, (11) on manifold (4). Torque adapters and pressure transducer cartridge to 13-15 ft/lbs (17.62-20.33 N•m).
- d. Install on each of the two NO valves, 12496925, (12) on manifold (4); one o-ring, MS28775-118, (13), one telfon backup, MS27595-019, (14), one o-ring, MS28775-019, (15), one telfon backup, MS27595-019, (14). Torque cartridges to 40-44 ft/lbs (54.23-59.65 N•m) and coils to 28-34 ft/lbs (37.96-46.09 N•m).

## SECTION II INSTALLATION OF NEW FORWARD LEFT MANIFOLD ASSEMBLY - CONTINUED

### 4-2 ASSEMBLY OF NEW FORWARD LEFT MANIFOLD - CONTINUED

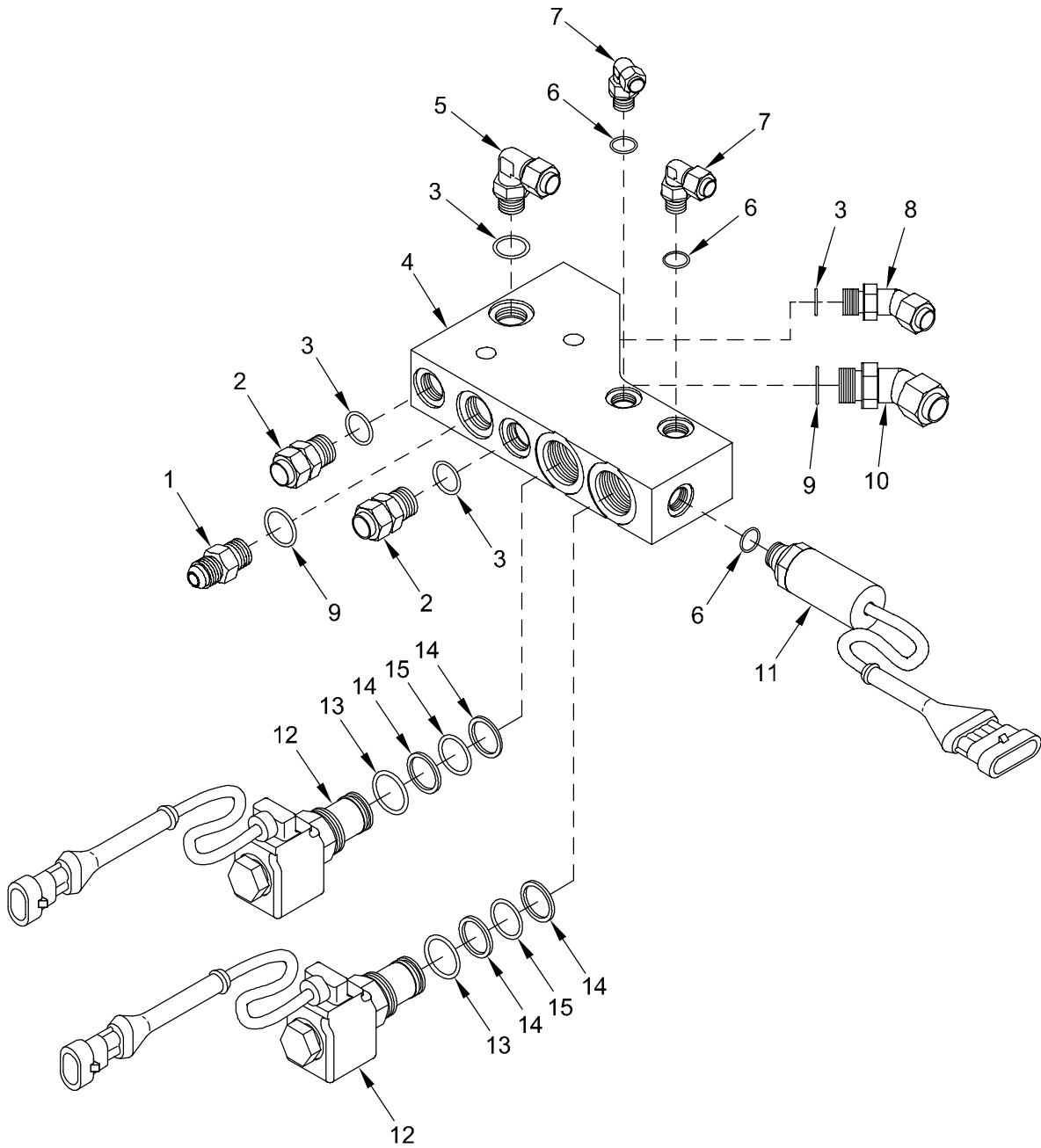

Figure 4-2. Forward Left Manifold Assembly

## SECTION II INSTALLATION OF NEW FORWARD LEFT MANIFOLD ASSEMBLY - CONTINUED

### 4-3 FORWARD LEFT MANIFOLD FUNCTIONALITY TESTING

#### CAUTION

Testing should be performed in a clean environment and protective dust covers or caps should be installed on all openings to prevent contamination. Dirt can damage parts and cause malfunctions.

#### NOTE

Prior to installing the primary manifold in vehicle, the following functionality tests should be performed.

#### NOTE

Steps a through c apply to Figure 4-3.

- a. Testing of hydraulic circuit port 9 (top of manifold) connected to two port 9's on either side of the manifold.
  1. Connect -6 pressure hose with 37° flare fitting to port 9 (top of manifold).
  2. Pressurize the port 9 hose to 1000 psig (6894.757 kilopascal) and a flow of approximately 5 GPM (18927.06 CPM) and verify flow is exiting from the other two port 9 fittings on the sides of the manifold, and that there is no fluid flowing from any other manifold ports.
  3. De-pressurize hose and disconnect from port 9.
- b. Testing hydraulic circuit port 3L (side of manifold) to port 3L on the opposite side of the manifold.
  1. Connect -8 pressure hose with 37° flare fitting to port 3L on either side of the manifold.
  2. Pressurize the port 3L hose to 1000 psig (6894.757 kilopascal) and a flow of approximately 5 GPM (18927.06 CPM) and verify flow is exiting from the port 3L fitting on the other side of the manifold and there is no other fluid flowing from any other manifold ports.
  3. De-pressurize hose and disconnect from port 3L.

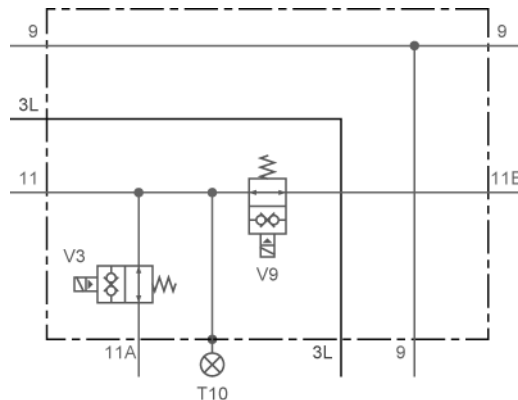

Figure 4-3. Forward Left Manifold Hydraulic Schematic Diagram

## **SECTION II INSTALLATION OF NEW FORWARD LEFT MANIFOLD ASSEMBLY - CONTINUED**

### **4-3 FORWARD LEFT MANIFOLD FUNCTIONALITY TESTING - CONTINUED**

- c. Testing hydraulic circuit port 11 (side of manifold) to ports 11A and 11B on the top of the manifold.
  1. Connect transducer test cable to T10.
  2. Connect -6 pressure hose with 37° flare fitting to port 11 on the side of the manifold.
  3. Connect valve test cable from the 28 VDC power supply to valves V3 and V9. Do not energize the power supply at this time.
  4. Pressurize port 11 hose to 1000 psig (6894.757 kilopascal) and flow of approximately 5 GPM (18927.06 CPM) and verify flow is exiting from ports 11A and 11B and there is no fluid flowing from any other manifold ports.
  5. Energize the 28 VDC power supply and verify the flow from ports 11A and 11B has stopped.
  6. Read the voltage at T10.
  7. De-pressurize hose and de-energize the 28 VDC power supply.
  8. Disconnect -6 pressure hose from port 11 and disconnect valve test cables from valves V3 and V9. Disconnect T10 transducer cable.
  9. This completes manifold functionality test.

## SECTION II INSTALLATION OF NEW FORWARD LEFT MANIFOLD ASSEMBLY - CONTINUED

### 4-4 INSTALLATION OF NEW FORWARD LEFT MANIFOLD ASSEMBLY

#### NOTE

Steps a and b below apply to Figure 4-4.

#### NOTE

It may be necessary to loosen valve coils on new forward left manifold assembly and slide them away from manifold to provide wrench clearance. However, if clearance is needed, to prevent damage to the coils, the coils should not be removed entirely.

- a. If necessary to provide wrench clearance, loosen (but do not remove) valve coils on new forward left manifold assembly and slide away from manifold assembly.
- b. Install new forward left manifold assembly, 12496949, (1), in same manner as previously installed forward left manifold that is being replaced, using two locking screws, B1821BH038C250L, (2) and two flat washers, 10910174-3, (3). Refer to TM 5-2350-262-20-2, Hydraulic Front Manifolds and Fittings Replacement, and to Figure 4-4, below. If necessary, valve coils may be loosened and slid away from the manifold to provide wrench clearance. Do not remove coil entirely.



Figure 4-4. Installation of New Forward Left Manifold Assembly

## SECTION II INSTALLATION OF NEW FORWARD LEFT MANIFOLD ASSEMBLY - CONTINUED

### 4-5 INTERCONNECTION OF NEW FORWARD LEFT MANIFOLD ASSEMBLY

#### NOTE

Steps a and b below apply to Figure 4-5 and Table 4-1.

- a. Locate hydraulic hoses identified in following procedures, change hose band markers as applicable, and connect to new forward left manifold assembly ports as indicated in Figure 4-5 and Table 4-1.
- b. Where applicable, replace identification and destination tags (band markers) attached to existing hydraulic hoses re-routed and/or relocated as part of modification. Band markers are contained in Underside Band Marker Kit, 12496969.

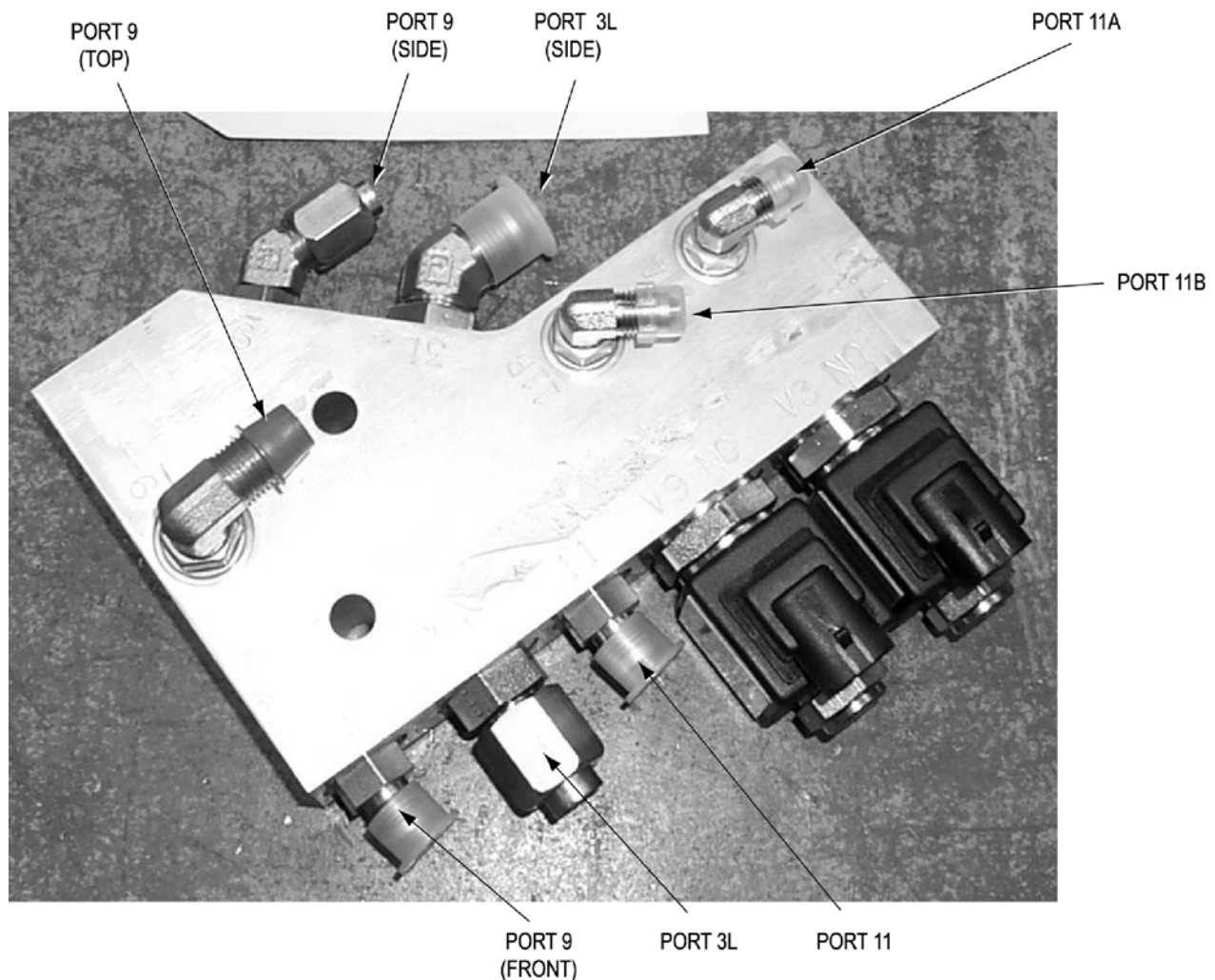

Figure 4-5. Identification of Forward Left Manifold Assembly ports

## SECTION II INSTALLATION OF NEW FORWARD LEFT MANIFOLD ASSEMBLY - CONTINUED

### 4-5 INTERCONNECTION OF NEW FORWARD LEFT MANIFOLD ASSEMBLY - CONTINUED

**Table 4-1. Interconnection of New Forward Left Manifold Assembly Hydraulic Hoses and Tubes**

From	Connects To New Forward Left Manifold Assembly port	Notes
Left Main Manifold port 9	Forward Left Manifold port 9 (Front)	same connection as for old manifold
Left Main Manifold port 3L	Forward Left Manifold port 3L (Front)	same connection as for old manifold
Left Main Manifold port 11	Forward Left Manifold port 11 (Front)	same connection as for old manifold
Left Side Sprung Stop Cylinder Retract (CKT 9)	Forward Left Manifold port 9 Elbow (Top)	same connection as for old manifold
Left Forward Actuator #1, port 9	Forward Left Manifold port 9 (Side)	same connection as for old manifold
Left Forward Actuator #1, port 3	Forward Left Manifold port 3L (Side)	same connection as for old manifold
Left Forward Actuator #1, port 11	Forward Left Manifold port 11A Elbow (Top)	Changed Hose 13214E2495-8 (changed from 13214E2495-2)
Left Side Sprung Stop Cylinder Extend (CKT 11 BHD FTG)	Forward Left Manifold port 11B Elbow (Top)	Changed Hose 13214E2495-9 (changed from 13214E2495-5)



## SECTION II INSTALLATION OF NEW FORWARD LEFT MANIFOLD ASSEMBLY - CONTINUED

### 4-5 INTERCONNECTION OF NEW FORWARD LEFT MANIFOLD ASSEMBLY - CONTINUED

#### NOTE

Steps c through e below apply to Figure 4-6 and Table 4-1.

- c. Remove hose, band marker 13214E2495-2 and install hose, 13214E2495-8, (3) between port 11A of new forward left manifold assembly (5) and port 11 of #1 suspension unit.
- d. Remove hose, band marker 13214E2495-5 and install hydraulic hose, 13214E2495-9, (4) between port 11B of new forward left manifold assembly (5) and circuit 11 bulkhead fitting.
- e. Connect remaining tagged hoses (1, 2, 6 through 9) removed from old forward left manifold to ports of new forward left manifold assembly (5), as listed in Table 4-1.

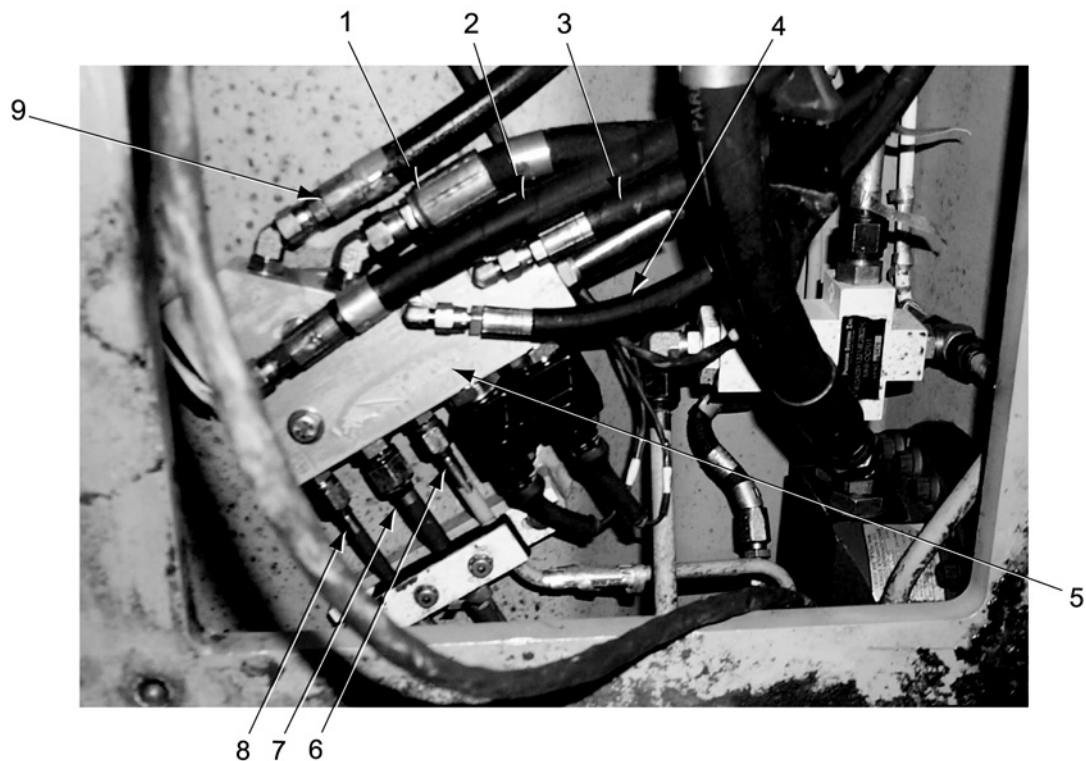

Figure 4-6. Installation and Interconnection of New Forward Left Manifold Assembly

## SECTION III INSTALLATION OF NEW FORWARD RIGHT MANIFOLD ASSEMBLY

### 4-6 REMOVAL OF EXISTING FORWARD RIGHT MANIFOLD ASSEMBLY

#### NOTE

Steps a and b below apply to Figure 4-7.

- a. Identify and tag all hoses connected to forward right manifold.
- b. Remove existing forward right manifold per TM 5-2350-262-20-2, Hydraulic Front Manifolds and Fittings Replacement. Discard two locking screws. Note orientation of ports 9, 3R, and 11 on front of manifold.

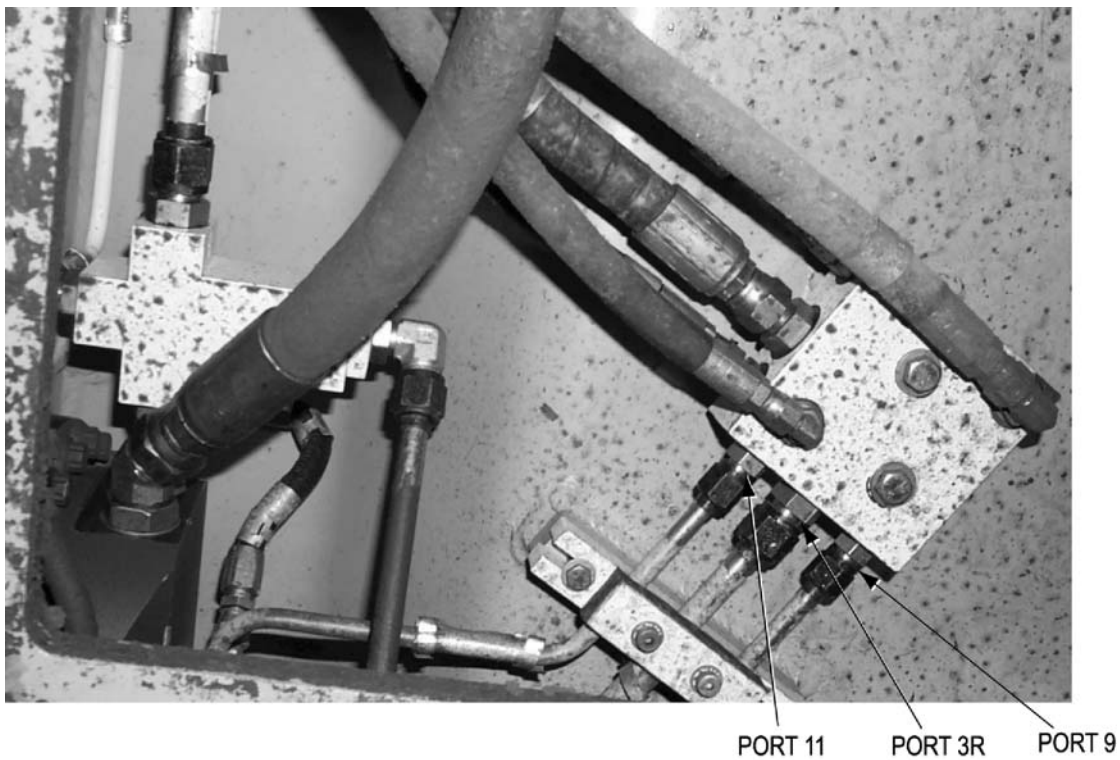

Figure 4-7. Existing Forward Right Manifold Assembly (Being Replaced)

## **SECTION III INSTALLATION OF NEW FORWARD RIGHT MANIFOLD ASSEMBLY - CONTINUED**

### **4-7 ASSEMBLY OF HDC FORWARD RIGHT MANIFOLD**

#### **CAUTION**

Assembly should be performed in a clean environment and protective dust covers or caps should be installed on all openings to prevent contamination. Dirt can damage parts and cause malfunctions.

#### **CAUTION**

When securing aft manifold in vice, exercise extreme care not to mar any surfaces or damage components.

#### **CAUTION**

Do not over torque. Failure to comply may result in damage to equipment.

#### **NOTE**

Steps a through d applies to Figure 4-8.

#### **NOTE**

A vice must be used to secure the primary manifold during assembly.

#### **NOTE**

Refer to Section I, Table 1-6, Forward Right Manifold Parts List, for required parts.

## SECTION III INSTALLATION OF NEW FORWARD LEFT MANIFOLD ASSEMBLY - CONTINUED

### 4-7 ASSEMBLY OF HDC FORWARD RIGHT MANIFOLD - CONTINUED

- a. Install three new o-rings, MS28778-4, (4), pressure transducer, 124969235, (1), and two 90° adapters, MS51527A4, (2) on manifold (9). Torque transducer cartridge to 13-15 ft/lbs (17.62-20.33 N•m) and adapters to 13-15 ft/lbs (17.62-20.33 N•m).
- b. Install two new o-rings, MS28778-8, (5), 45° adapter, 13211E8916-1, (3), and straight adapter, AC-1-310, (11) on manifold (9). Torque adapters to 40-43 ft/lbs (54.23-58.30 N•m).
- c. Install four new o-rings, MS28778-6, (7), 45° adapter, 13211E8916-6, (6), 90° adapter, MS51527A6, (8), and two straight adapters, MS51525A6, (2) on manifold (9). Torque adapters to 22-24 ft/lbs (29.82-32.53 N•m).
- d. Install on each of two NO valves, 12496925, (12) on manifold (9); one o-ring, MS28775-118, (13), one telfon backup, MS27595-019, (14), one o-ring, MS28775-019, (15), and one telfon backup, MS27595-019, (14). Torque cartridges to 40-44 ft/lbs (54.23-59.65 N•m) and coils to 28-34 ft/lbs (37.96-46.09 N•m).

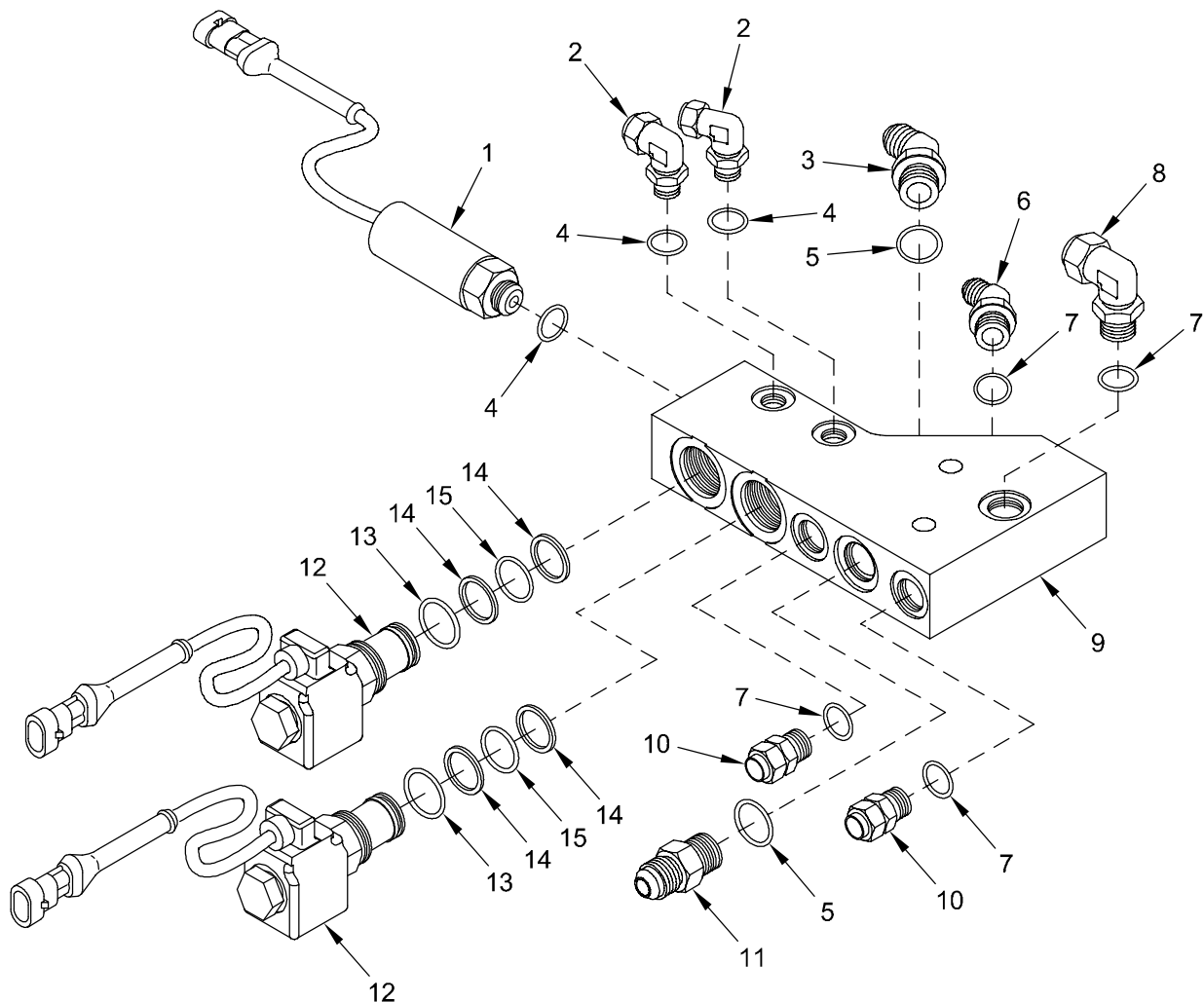

Figure 4-8. Forward Right Manifold Assembly

## SECTION III INSTALLATION OF NEW FORWARD RIGHT MANIFOLD ASSEMBLY - CONTINUED

### 4-8 FORWARD RIGHT MANIFOLD FUNCTIONALITY TESTING

#### CAUTION

Testing should be performed in a clean environment and protective dust covers or caps should be installed on all openings to prevent contamination. Dirt can damage parts and cause malfunctions.

#### NOTE

Prior to installing the primary manifold in vehicle, the following functionality tests should be performed.

#### NOTE

Steps a through c apply to Figure 4-9.

- a. Testing hydraulic circuit port 9 (top of manifold) to two port 9's on either side of the manifold.
  1. Connect -4 pressure hose with 37° flare fitting to port 9 (top of manifold).
  2. Pressurize port 9 hose to 1000 psig (6894.757 kilopascal) and flow of approximately 5 GPM (18927.06 CPM) and verify flow is exiting from other two port 9 fittings on sides of manifold, and that no fluid is flowing from any other manifold ports.
  3. De-pressurize hose and disconnect from port 9.
- b. Testing hydraulic circuit port 3R (side of manifold) to port 3R on opposite side of manifold.
  1. Connect -8 pressure hose with 37° flare fitting to port 3R on either side of the manifold.
  2. Pressurize port 3R hose to 1000 psig (6894.757 kilopascal) and flow of approximately 5 GPM (18927.06 CPM) and verify flow is exiting from other port 3R fitting on side of manifold, and that no fluid is flowing from any other manifold ports.
  3. De-pressurize hose and disconnect from port 3R.

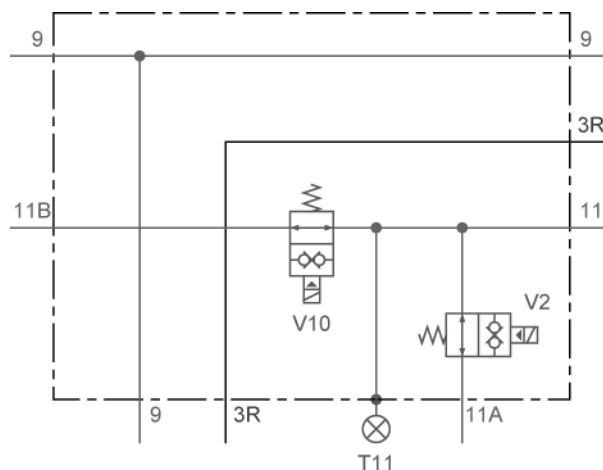
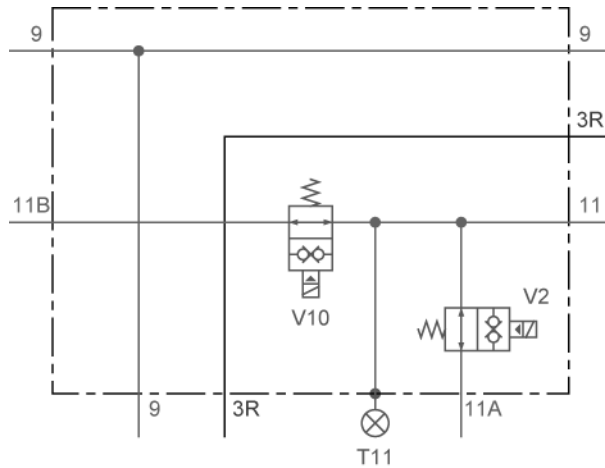

Figure 4-9. Forward Right Manifold Hydraulic Schematic Diagram

## SECTION III INSTALLATION OF NEW FORWARD RIGHT MANIFOLD ASSEMBLY - CONTINUED

### 4-8 FORWARD RIGHT MANIFOLD FUNCTIONALITY TESTING - CONTINUED

- c. Testing hydraulic circuit port 11 (side of manifold) to ports 11A and 11B on the top of the manifold.
  1. Connect transducer test cable to T11.
  2. Connect -6 pressure hose with 37° flare fitting to port 11 on side of the manifold.
  3. Connect valve test cable from 28 VDC power supply to valves V2 and V10. Do not energize the power supply at this time.
  4. Pressurize port 11 hose to 1000 psig (6894.757 kilopascal) and flow of approximately 5 GPM (18927.06 CPM) and verify flow is exiting from ports 11A and 11B and that no fluid is flowing from any other manifold ports.
  5. Energize 28 VDC power supply and verify flow from ports 11A and 11B has stopped.
  6. Read the voltage at T11.
  7. De-pressurize port 11 hose and de-energize 28 VDC power supply.
  8. Disconnect -4 pressure hose from port 11 and disconnect valve test cables from valves V2 and V10. Disconnect T11 transducer cable.
  9. This completes the manifold functionality test.



**Figure 4-9. Forward Right Manifold Hydraulic Schematic Diagram**

## SECTION III INSTALLATION OF NEW FORWARD RIGHT MANIFOLD ASSEMBLY - CONTINUED

### 4-9 INSTALLATION OF NEW FORWARD RIGHT MANIFOLD ASSEMBLY

#### NOTE

Steps a and b below apply to Figure 4-10.

- a. If necessary to provide wrench clearance, loosen (but do not remove) valve coils on new forward right manifold assembly and slide away from manifold assembly.
- b. Install new forward right manifold assembly, 12496942, (1), in same manner as previously installed forward right manifold, using two locking screws, B1821BH038C250L, (3) and two flat washers, 10910174-3, (2). Refer to TM 5-2350-262-20-2, Hydraulic Front Manifolds and Fittings Replacement, and to Figure 4-10. If necessary, valve coils may be loosened and slid away from the manifold to provide wrench clearance. Do not remove coil entirely.



Figure 4-10. Installation of New Forward Right Manifold Assembly

### SECTION III INSTALLATION OF NEW FORWARD RIGHT MANIFOLD ASSEMBLY - CONTINUED

#### 4-10 INTERCONNECTION OF NEW FORWARD RIGHT MANIFOLD ASSEMBLY

##### NOTE

Steps a and b below apply to Figure 4-11 and Table 4-2.

- a. Locate hydraulic hoses identified in following procedures, change hose band markers as applicable, and connect to new forward right manifold assembly ports as indicated in Figure 4-11 and Table 4-2.
- b. Where applicable, replace identification and destination tags (band markers) attached to existing hydraulic hoses re-routed and/or relocated as part of modification. Band markers are contained in Underside Band Marker Kit, 12496969.

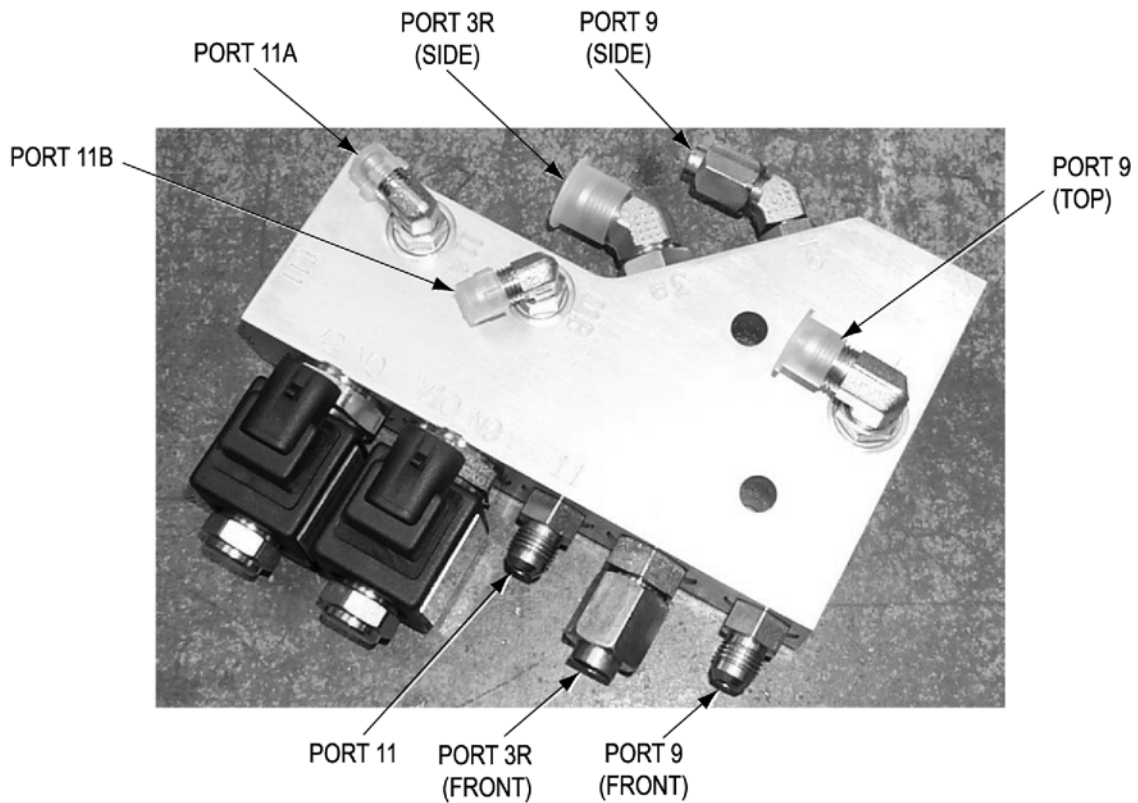

Figure 4-11. Identification of Forward Right Manifold Assembly ports



## SECTION III INSTALLATION OF NEW FORWARD RIGHT MANIFOLD ASSEMBLY - CONTINUED

### 4-10 INTERCONNECTION OF NEW FORWARD RIGHT MANIFOLD ASSEMBLY - CONTINUED

Table 4-2. Interconnection of New Forward Right Manifold Assembly Hydraulic Hoses and Tubes

From	Connects To New Forward Right Manifold Assembly port	Notes
Right Main Manifold port 9	Forward Right Manifold port 9 (Front)	same connection as for old manifold
Right Main Manifold port 3R	Forward Right Manifold port 3R (Front)	same connection as for old manifold
Right Main Manifold port 11	Forward Right Manifold port 11 (Front)	same connection as for old manifold
Right Side Sprung Stop Cylinder Retract (CKT 9)	Forward Right Manifold port 9 Elbow (Top)	same connection as for old manifold
Right Forward Actuator #1, port 9	Forward Right Manifold port 9 (Side)	same connection as for old manifold
Right Forward Actuator #1, port 3	Forward Right Manifold port 3R (Side)	same connection as for old manifold
Right Forward Actuator #1, port 11	Forward Right Manifold port 11A Elbow (Top)	Changed Hose 13214E2495-8 (changed from 13214E2495-2)
Right Side Sprung Stop Cylinder Extend	Forward Right Manifold port 11B Elbow (Top)	Changed Hose 13214E2495-9 (changed from 13214E2495-5)

### SECTION III INSTALLATION OF NEW FORWARD RIGHT MANIFOLD ASSEMBLY - CONTINUED

#### 4-10 INTERCONNECTION OF NEW FORWARD RIGHT MANIFOLD ASSEMBLY - CONTINUED

##### NOTE

Steps c through e below apply to Figure 4-12 and Table 4-2.

- c. Remove hose, band marker 13214E2495-2 and install hose, 13214E2495-8, (9) between port 11A of forward right manifold assembly (4) and port 11 of #1 right suspension unit.
- d. Remove hose, band marker 13214E2495-5 and install hose, 13214E2495-9, (8) between port 11B of forward right manifold assembly (4) and circuit 11 bulkhead fitting.
- e. Connect remaining tagged hoses (1 through 3) and (5 through 7) removed from old forward right manifold to ports of new forward right manifold assembly (4) as listed in Table 4-2.

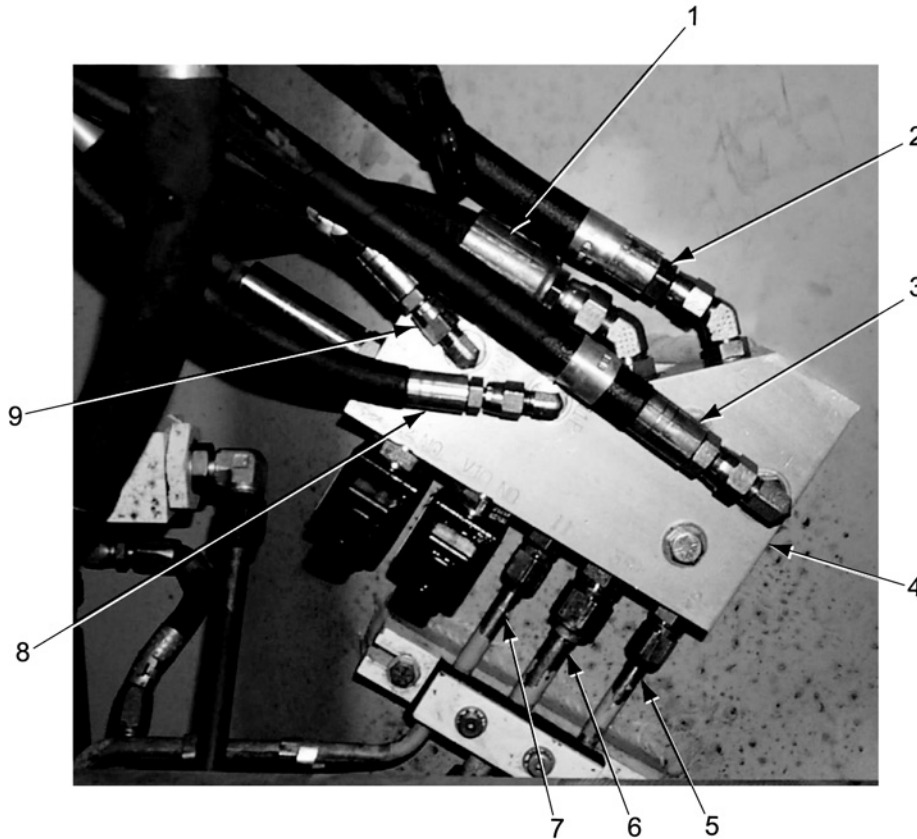

Figure 4-12. Installation and Interconnection of New Forward Right Manifold Assembly

## SECTION IV INSTALLATION OF AFT MANIFOLD ASSEMBLY

### 4-11 PREPARATION FOR INSTALLATION OF AFT MANIFOLD ASSEMBLY

- a. Access area to be modified from beneath rear left hull access cover.
- b. Access rear left rotary actuator #4.
- c. Remove end of hose, 13214E2495-1, from port 11 on left main manifold. Other end of this hose connects to port 11 of #4 rear left rotary actuator (rear suspension unit).
- d. Remove end of hose, 13214E2486, connected to port 2 on #3 left rotary actuator from port 2 of #4 rear left rotary actuator.
- e. Remove end of hose, 13214E2501-2, from port 9 on #4 rear left rotary actuator. Other end of this hose connects to tee connector on port 9 of left main manifold).

## SECTION IV INSTALLATION OF AFT MANIFOLD ASSEMBLY - CONTINUED

### 4-12 ASSEMBLY OF HDC AFT MANIFOLD

#### CAUTION

Assembly should be performed in a clean environment and protective dust covers or caps should be installed on all openings to prevent contamination. Dirt can damage parts and cause malfunctions.

#### CAUTION

When securing aft manifold in vice, exercise extreme care not to mar any surfaces or damage components.

#### CAUTION

Do not over torque. Failure to comply may result in damage to equipment.

#### NOTE

Steps a through e applies to Figure 4-13.

#### NOTE

A vice must be used to secure the aft manifold during assembly.

#### NOTE

Refer to Section I, Table 1-7, Aft Manifold Parts List, for required parts.

- a. Install on four NO valves, 12496925, (1), and one NC valve, 12496926 (16), one o-ring, MS28775-118, (2), one backup, MS27595-019, (3), one o-ring, MS28775-019, (4), and one backup, MS27595-019, (3) on manifold (10).
- b. Install two new o-rings, MS28778-6, (6), 90° adapter, MS51527A6, (5) and straight adapter, MS51525A6, (9) on manifold (10). Torque 90° adapter to 22-24 ft/lbs (29.82-32.53 N•m).
- c. Install new o-ring, MS28778-8, (7) and plug, 12335054-5, (8) on manifold (10). Torque plug to 40-43 ft/lbs (54.23-58.30 N•m).
- d. Install two new o-rings, MS 28788-12, (11) and two straight adapters, MS51525A12, (12) on manifold (10). Torque adapters to 68-75 ft/lbs (92.19-101.68 N•m).
- e. Install two new o-rings, MS28778-4, (9), straight adapter, MS51525A4, (14), and 90° adapter, MS51527A4, (14) on manifold (10). Torque adapters to 13-15 ft/lbs (17.62-20.33 N•m).

# SECTION IV INSTALLATION OF AFT MANIFOLD ASSEMBLY - CONTINUED

## 4-12 ASSEMBLY OF HDC AFT MANIFOLD - CONTINUED

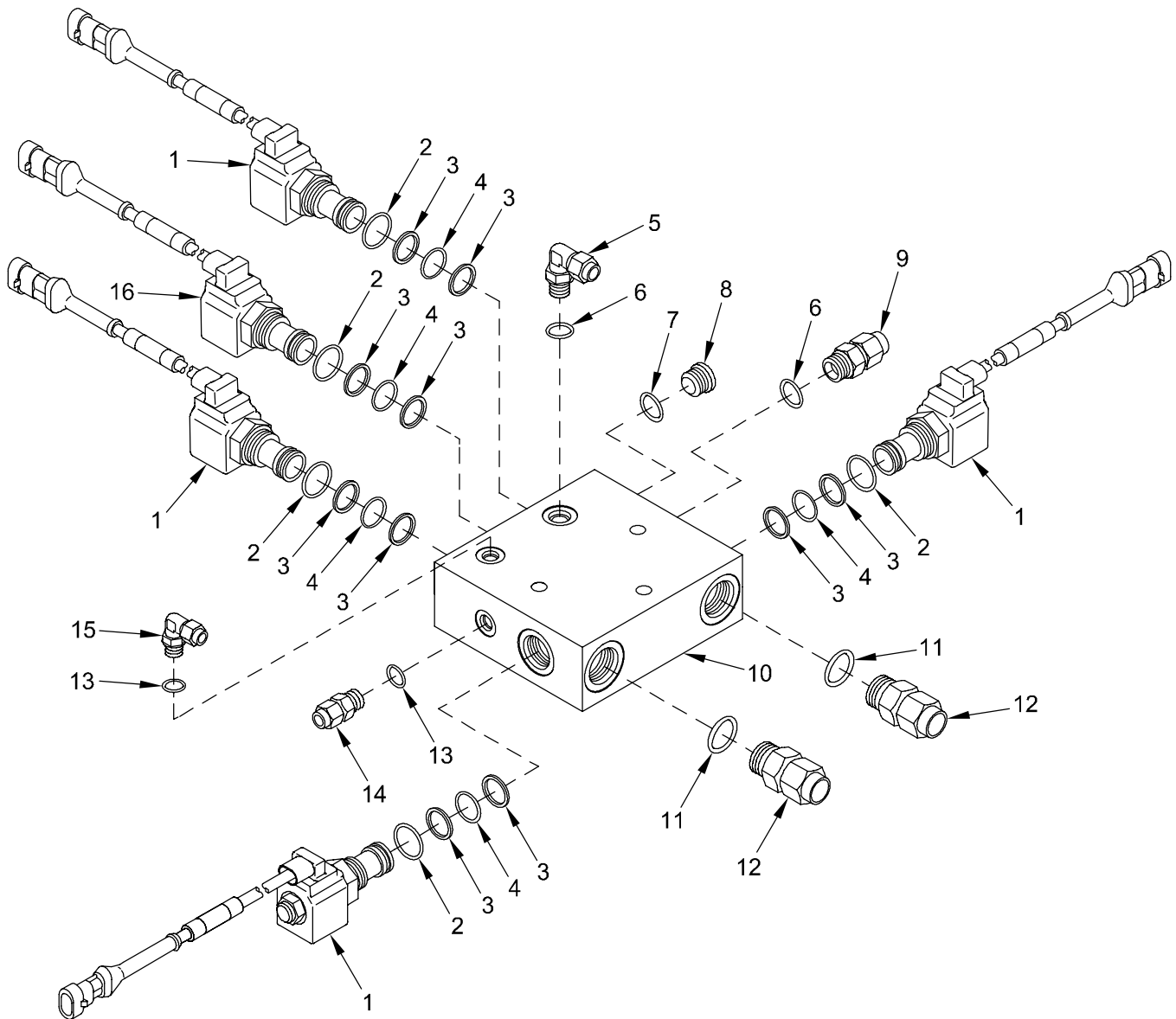

Figure 4-13. Aft Manifold Assembly

## SECTION IV INSTALLATION OF AFT MANIFOLD ASSEMBLY - CONTINUED

### 4-13 AFT LEFT MANIFOLD FUNCTIONALITY TESTING

#### CAUTION

Testing should be performed in a clean environment and protective dust covers or caps should be installed on all openings to prevent contamination. Dirt can damage parts and cause malfunctions.

#### NOTE

Prior to installing the aft manifold in a vehicle, the following functionality tests should be performed.

#### NOTE

Steps a through c apply to Figure 4-14.

- a. Testing hydraulic circuit port 9 to port 9B
  1. Connect -6 hose with 37° flare fitting to port 9 (top of manifold).
  2. Connect valve test cable from 28 VDC power supply to valve V4, do not energize power supply at this time.
  3. Pressurize port 9 hose to a pressure that provides flow and verify flow exiting port 9B.
  4. Energize the 28 VDC power supply and verify flow from port 9B has stopped.
  5. De-pressurize port 9 hose and de-energize 28 VDC power supply.

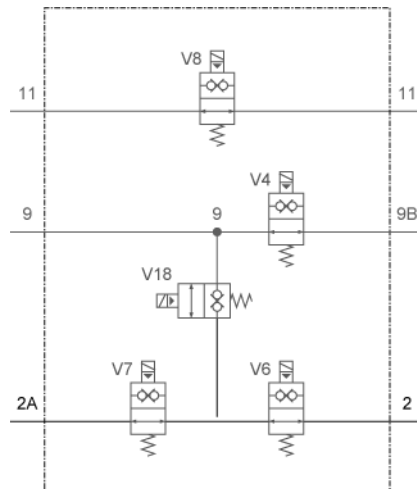

Figure 4-14. Aft Manifold Hydraulic Schematic Diagram

## SECTION IV INSTALLATION OF AFT MANIFOLD ASSEMBLY - CONTINUED

### 4-13 AFT LEFT MANIFOLD FUNCTIONALITY TESTING - CONTINUED

- b. Testing hydraulic circuits port 9 to ports 2 and 2A
  1. Connect valve test cable from 28 VDC power supply to valve V18, do not energize power supply at time.
  2. Pressurize port 9 hose to 1000 psig (6894.757 kilopascal) and flow of approximately 5 GPM (18927.06 CPM) and verify flow is only exiting port 9B.
  3. Energize 28 VDC power supply and verify flow from port 9B has stopped and that fluid flow is exiting from ports 2 and 2A.
  4. De-pressurize port 9 and de-energize 28 VDC power supply.
  5. Install -6 37° flare nut cap on to port 9B.
  6. Remove the test cable from valve V4.
  7. Connect a valve test cable from 28 VDC power supply to valve V7, do not energize power supply at this time.
  8. Pressurize port 9 hose to 1000 psig (6894.757 kilopascal) and verify no flow is exiting from any manifold ports.
  9. Energize 28 VDC power supply and verify fluid flow is only exiting from port 2.
  10. De-pressurize port 9 hose and de-energize 28 VDC power supply.
  11. Connect a valve test cable from a 28 VDC power supply to valve V6 and remove valve test cable from valve V7, do not energize power supply at this time.
  12. Pressurize port 9 hose to 1000 psig (6894.757 kilopascal) and verify no flow is exiting from any manifold ports.
  13. Energize 28 VDC power supply and verify that fluid is only exiting from port 2A.
  14. De-pressurize port 9 hose and de-energize 28 VDC power supply.
  15. Disconnect pressure -6 hose from port 9 and disconnect valve test cables from valves V18 and V6.
- c. Testing hydraulic circuit port 11 to port 11 through the manifold.
  1. Connect valve test cable from a 28 VDC power supply to valve V8. Do not energize the power supply at this time.
  2. Connect -4 pressure hose with 37° flare fitting to port 11 (top of manifold).
  3. Pressurize port 11 hose to 1000 psig (6894.757 kilopascal) and a flow of approximately 5 GPM (18927.06 CPM) and verify flow is exiting from port 11 on the side of the manifold and no other manifold ports.
  4. Energize 28 VDC power supply and verify flow from port 11 has stopped.
  5. De-pressurize port 9 hose and de-energize 28 VDC power supply.
  6. Disconnect -4 pressure hose from port 11 and disconnect valve test cable from valve V8.
  7. This completes manifold functionality test.

## SECTION IV INSTALLATION OF AFT MANIFOLD ASSEMBLY - CONTINUED

### 4-14 INSTALLATION OF AFT MANIFOLD ASSEMBLY IN VEHICLES WITH 1" THICK HULL BOTTOMS

#### NOTE

Steps a through e below apply to Figure 4-15.

- Determine proper location of aft manifold assembly mounting holes as shown in Figure 4-15.
- Mark locations for drilling mounting holes for inserts to mount aft manifold assembly.
- Drill and tap three holes for mounting aft manifold assembly using 33/64" drill bit and 9/16"-12 tap.
- Install three inserts, MS51831-104, (3) in holes in bottom of hull.
- Install aft manifold assembly, 12496951, (4) on bottom of vehicle hull using three locking screws, B1821BH038C325L, (1) and three flat washers, 10910174-3, (2).

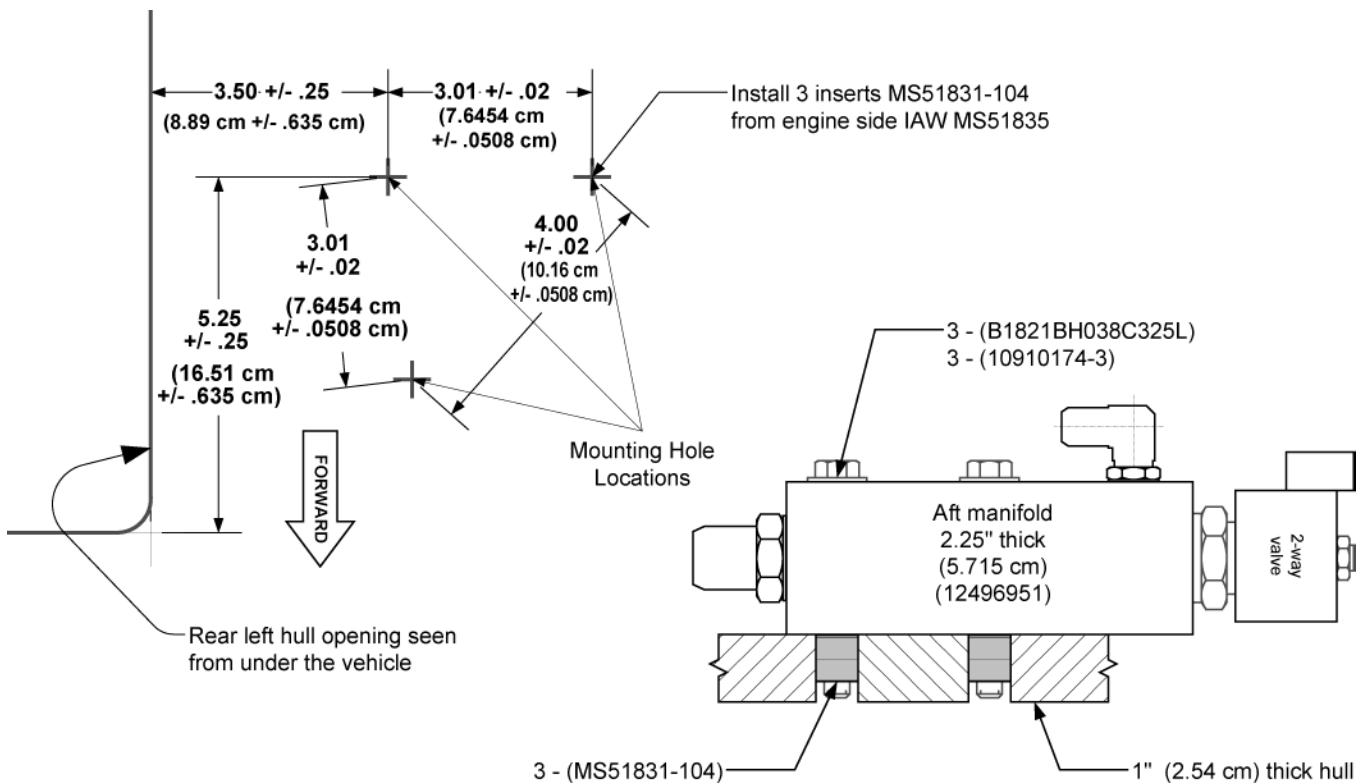

Figure 4-15. Mounting and Installation of Aft Manifold on 1" (2.54 cm) Thick Hull



## SECTION IV INSTALLATION OF AFT MANIFOLD ASSEMBLY - CONTINUED

### 4-15 INTERCONNECTION OF AFT MANIFOLD ASSEMBLY

#### NOTE

Steps a through i below apply to Figures 4-16 and 4-17. All numbered callouts apply to Figure 4-16.

- a. Locate hydraulic components identified in following procedure and connect to aft manifold assembly ports as indicated in Figures 4-16, 4-17, and Table 4-3. Figure 4-16 shows mounting on 1" (2.54 cm) hull bottom with aft manifold assembly (3) mounted to vehicle hull with three locking screws, B1821BH038C325L, (2) and three flat washers, 10910174-3, (1).
- b. Where applicable, replace identification and destination tags (band markers) attached to hydraulic hoses re-routed and/or relocated as part of modification. Band markers are contained in Underside Band Marker Kit, 12496969.
- c. Install two 90° swivel, MS51521A6, (6) on aft manifold assembly port 9B.
- d. Install new hydraulic hose, 13214E2495-6, (9) between port 11 (side) of aft manifold assembly and port 11 (rear) of left main manifold.
- e. Install new hydraulic hose, 13214E2501-11, (5) between port 9B of aft manifold assembly and port 9 of #4 left rear actuator (rear suspension unit).
- f. Install new -12 hydraulic hose, 13214E2486-2, (8) between port 2A of aft manifold assembly and port 2 of #3 left actuator. Rotate 45° fitting on port 2 of #4 rotary actuator as required for proper fit/connection.
- g. Remove hose, band marker 13214E2495-1 and install hose, 13214E2495-7, (10) between port 11 (top) of aft manifold assembly and port 11 of #4 left rear rotary actuator.
- h. Remove hose, band marker 13214E2501-2 and install hose, 13214E2501-7, (4) between port 9 of aft manifold assembly and port 9 of left main manifold (rear side).
- i. Remove hose, band marker 13214E2486 and install hose, 13214E2486-3, (7) between port 2 of aft manifold assembly and port 2 of #4 left rear actuator.

## SECTION IV INSTALLATION OF AFT MANIFOLD ASSEMBLY - CONTINUED

### 4-15 INTERCONNECTION OF AFT MANIFOLD ASSEMBLY - CONTINUED

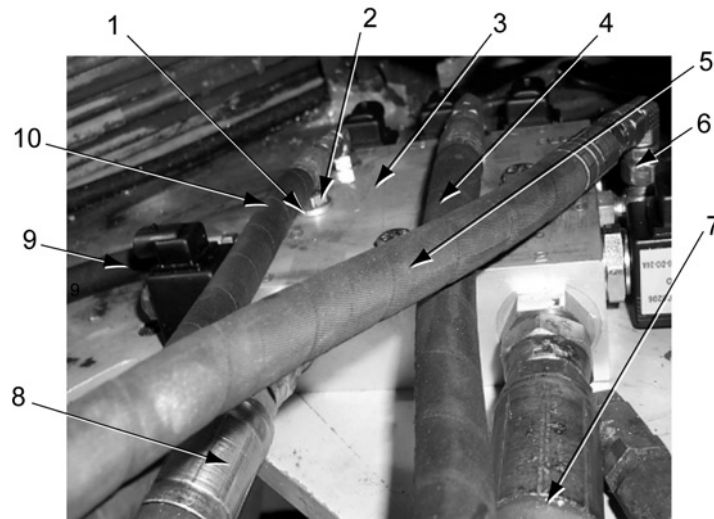

Figure 4-16. Interconnection of Aft Manifold Assembly on 1" Thick Hull Bottom

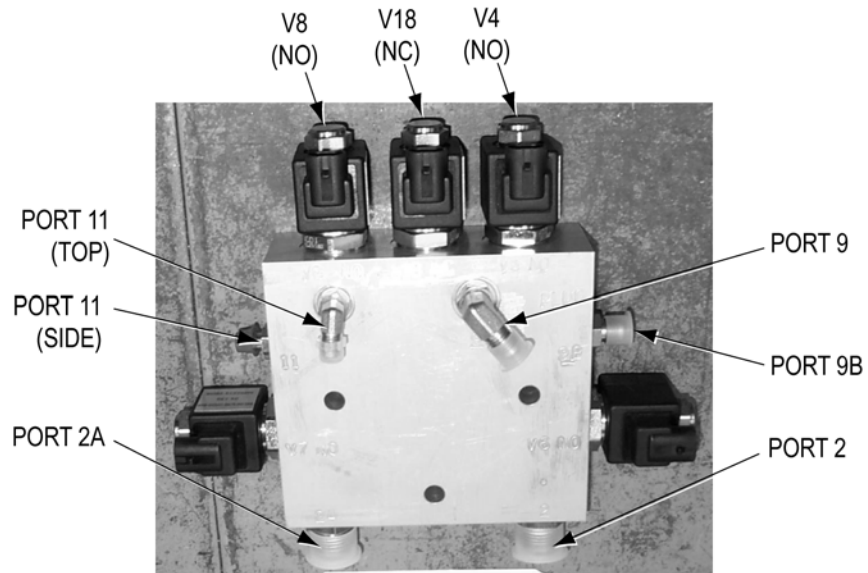

Figure 4-17. Identification of Aft Manifold Assembly ports

**SECTION IV INSTALLATION OF AFT MANIFOLD ASSEMBLY - CONTINUED****4-15 INTERCONNECTION OF AFT MANIFOLD ASSEMBLY - CONTINUED****Table 4-3. Interconnection of Aft Manifold Assembly Hydraulic Hoses**

<b>Hose or Tube</b>	<b>From</b>	<b>Connects To Aft Manifold Assembly port</b>	<b>Notes</b>
13214E2495-6	Left Main Manifold Rear port 11	Aft Manifold port 11 (side)	New Hose
13214E2501-7 (changed tag from 13214E2501-2)	Left Main Manifold port 9 (rear side)	Aft Manifold port 9	Re-tag and re-route hose
13214E2486-3 (changed tag from 13214E2486)	Left Intermediate Actuator (3) port 2 (Intermediate SPNSN Unit)	Aft Manifold port 2A	Re-tag and re-route hose
13214E2495-7 (changed tag from 13214E2495-1)	port 11 on Rear Left Rotary Actuator #4	Aft Manifold port 11 (top)	Re-tag and re-route hose
13214E2501-11	port 9 on Rear Left Rotary Actuator #4 (Rear SPNSN Unit)	Aft Manifold port 9B	New Hose
13214E2486-2	port 2 on Rear Left Rotary Actuator #4	Aft Manifold port 2	New Hose



## **CHAPTER 5**

# **MODIFICATIONS TO VEHICLE ELECTRICAL SYSTEM TO PROVIDE ELECTRICAL INTERFACE AND POWER TO HDC SYSTEM**

**SUBJECT:** Modifications to vehicle electrical system to provide electrical interface and power to HDC System.

**DATE:** 29 August 2008

**DESCRIPTION:** Modifications are made to vehicle electrical system in several areas of vehicle to provide DC operating voltage for HDC System and to HDC solenoid valves and pressure transducers that interface with vehicle hydraulic system assemblies and components.

Modifications to vehicle electrical system in driver's compartment consist of adding a circuit breaker to the umbilical cable disconnect bracket (installed in Chapter 2) in the front of driver's compartment to control distribution of power to HDC system, routing the application of HDC power through the existing parking brake relay, and routing/interconnecting an HDC power cable assembly (W1).

An upper cable assembly (W2) provides electrical interconnection between HDC components in the bowl area and the HDC control box interface at the umbilical cable disconnect bracket.

A lower cable assembly (W3) provides electrical interconnection between HDC components in the lower forward portion of the bowl area and on the underside of the vehicle, and the HDC control box interface at the umbilical cable disconnect bracket.

The HDC power cable assembly (W1) provides electrical interconnection between vehicle power and the HDC Control Box interface at the umbilical cable disconnect bracket.

An umbilical cable assembly (W4) provides electrical interconnection between the three HDC cable assemblies in the vehicle and the HDC control box (at the umbilical cable disconnect bracket).

**TM REFERENCES:** The technical manual references in this procedure are for:

TM 5-2350-262-10, dated June 1992, with Change 7, dated June 2007

TM 5-2350-262-20-1, dated January 1997, with Change 4, dated July 2007

TM 5-2350-262-20-2, dated January 1997, with Change 4, dated July 2007

TM 5-2350-262-20-3, dated January 1997, with Change 4, dated July 2007

TM 5-2350-378-24&P

## SECTION I PREPARATION FOR MODIFICATION

### WARNING

High pressure is present in the M9 hydraulic system. Do not disconnect any hydraulic system component unless hydraulic system pressure has been relieved. Ensure each of the hydraulic control levers is moved several times through all positions, and the hydraulic tank dipstick is slowly loosened to release pressure. After hydraulic pressure has been relieved, wait at least four (4) minutes before disconnecting any hose or fitting. Failure to comply may result in severe injury to personnel.

### WARNING

Ensure that vehicle power is off and battery disconnected. Remove all jewelry, such as rings, dog tags, bracelets, etc. If jewelry or disconnected battery ground cable contacts battery positive terminal, a direct short will result, causing instant heating of tools, tool damage, battery damage, or battery explosion. Failure to comply may result in severe injury or death.

### CAUTION

All exposed electrical contacts and connectors should be capped, protected, or sealed to prevent damage.

### CAUTION

Cap or plug all oil ports and ends of hoses and tubes when oil hoses or tubes are disconnected or removed to prevent contamination. Failure to comply may result in damage to equipment.

### NOTE

Drain oil and collect into suitable containers when hoses and tubes are disconnected or removed.

- a. If not previously accomplished, raise and lock apron in full-up (full-open) position per TM 5-2350-262-10.
- b. If not previously accomplished, disconnect vehicle battery power per TM 5-2350-262-20-1, Battery Cable Replacement, Negative Cables Disconnect.

## SECTION II INSTALLATION AND PRELIMINARY ROUTING OF HDC CABLE ASSEMBLIES

### NOTE

There are three HDC electrical cable assemblies installed in vehicle. Each cable assembly interfaces with different vehicle assemblies and components and all three cables attach to the umbilical cable disconnect bracket in driver's compartment. The three cable assemblies are internally routed to HDC components and assemblies that interface with vehicle hydraulic system assemblies and components in bowl area and on underside of vehicle. Two individuals are required to properly route cables to various parts of vehicle.

### NOTE

Steps a and b below apply to Figure 5-1. Reference should also be made to FO 5-1.

- a. While standing in bowl area, uncoil single connector end J1 (2) of upper cable assembly W2, 12496954, (1) and feed cable assembly up through access cover opening in upper portion of bowl area (created by removal of access cover modified in Chapter 3, Section V) into driver's compartment.
- b. Carefully route cable connector W2J1 up through access cover opening to back of umbilical cable disconnect bracket, 12496964, (3) as shown on Figure 5-1.

**FO 5-1. Upper Cable Assembly W2**

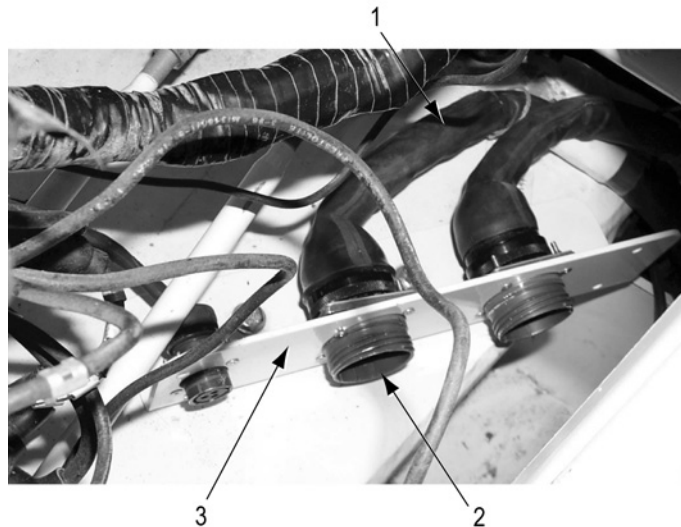

**Figure 5-1. Initial Placement of Upper Cable Assembly W2**

## SECTION II INSTALLATION AND PRELIMINARY ROUTING OF HDC CABLE ASSEMBLIES - CONTINUED

### NOTE

Steps c and d below apply to Figure 5-2.

- c. Orient large key (1) of cable connector W2J1 at 12 o'clock position and place in middle opening in umbilical cable disconnect bracket (3) as shown. All cable connectors are installed on umbilical cable disconnect bracket with four socket head cap screws, MS24667-4, (2).
- d. Orient large key (1) of cable connector W1J1 at 12 o'clock position and place in left most opening (4) in umbilical cable disconnect bracket (3) as shown for a typical connector.

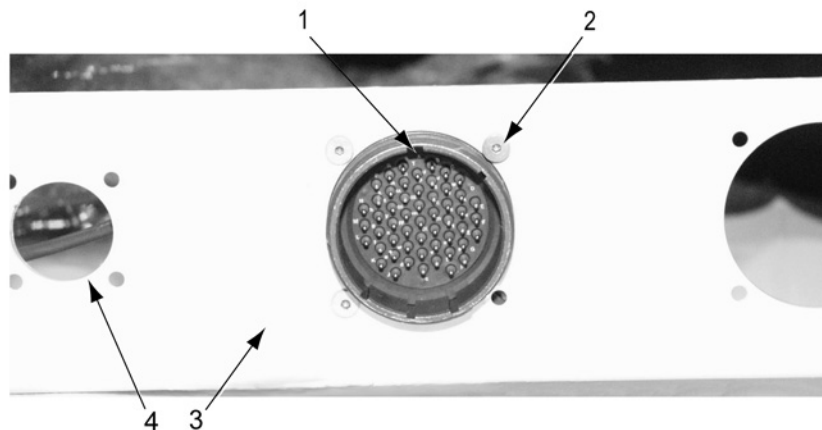

Figure 5-2. Cable Connector Installation Orientation (Typical)



## SECTION II INSTALLATION AND PRELIMINARY ROUTING OF HDC CABLE ASSEMBLIES - CONTINUED

### NOTE

Steps e through p apply to Figure 5-3.

- e. Position nutplate, M85049/95-22A, (2) over upper cable assembly W2J1 end of cable (3) at center location on back of umbilical cable disconnect bracket (7). Place dustcap lanyard (4) behind top left screw on connector (6) between connector and bracket. Refer to Figure 5-3 for illustration of typical connector installed on umbilical cable disconnect bracket (7).
- f. Attach upper cable assembly connector W2J1 (3) and dustcap lanyard (4) to nutplate (2) using four screws, MS24667-4, (1).
- g. Place dustcap, D38999/33W23R, (5) over exposed cable connector W2J1.
- h. Ensure upper cable assembly W2 (8) is not bent or twisted during installation on umbilical cable disconnect bracket (7).

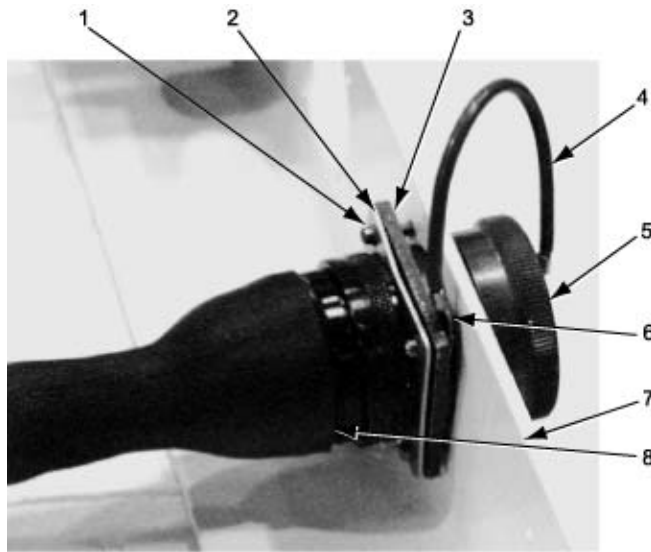

Figure 5-3. Typical Cable Connector Installation

## SECTION II INSTALLATION AND PRELIMINARY ROUTING OF HDC CABLE ASSEMBLIES - CONTINUED

- i. Position nutplate (2) over lower cable assembly W3J1 end of cable (3) at right most connector location on back of umbilical cable disconnect bracket (7). Place dustcap lanyard (4) behind top left screw on connector (6) between connector and bracket. Refer to Figure 5-3 for illustration of typical connector installed on umbilical cable disconnect bracket (7).
- j. Attach lower cable assembly connector W3J1 (3) and dustcap lanyard (4) to nutplate (2) using four screws (1).
- k. Place dustcap (5) over exposed cable connector W3J1.
- l. Ensure lower cable assembly W3 (8) is not bent or twisted during installation on umbilical cable disconnect bracket (7).
- m. Position nutplate, M85049/95-12A, (2) over power cable assembly W1J1 end of cable (3) at left most connector location on back of umbilical cable disconnect bracket (7). Place dustcap lanyard, MS3181-12CA, (4) behind top left screw on connector (6) between connector and bracket. Refer to Figure 5-3 for illustration of typical connector installed on umbilical cable disconnect bracket (7).
- n. Attach power cable assembly connector W1J1 (3) and dustcap lanyard (4) to nutplate (2) using four screws, MS24667-4, (1).
- o. Place dustcap (5) over exposed cable connector W1J1.
- p. Ensure power cable assembly W1 (8) is not bent or twisted during installation on umbilical cable disconnect bracket (7).

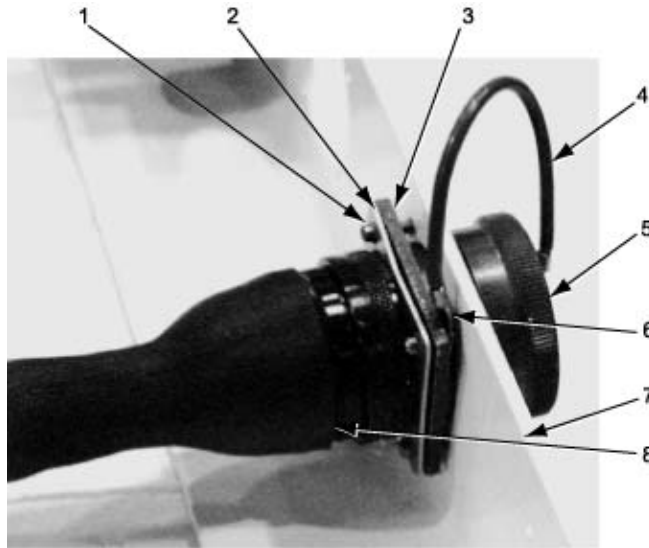

Figure 5-3. Typical Cable Connector Installation

## SECTION II INSTALLATION AND PRELIMINARY ROUTING OF HDC CABLE ASSEMBLIES - CONTINUED

### NOTE

Step q below applies to Figure 5-4.

- q. Route branches of upper cable assembly W2 (3) from access cover opening down into bowl area near left side of DCV bank and primary manifold, as shown in Figure 5-4. Callouts 1, 2, 3 and 5 identify final placement of different portions of cable assembly W2 when it is installed. Callout 4 shows the initial placement of lower cable assembly W3 in bowl area relative to upper cable assembly W2.

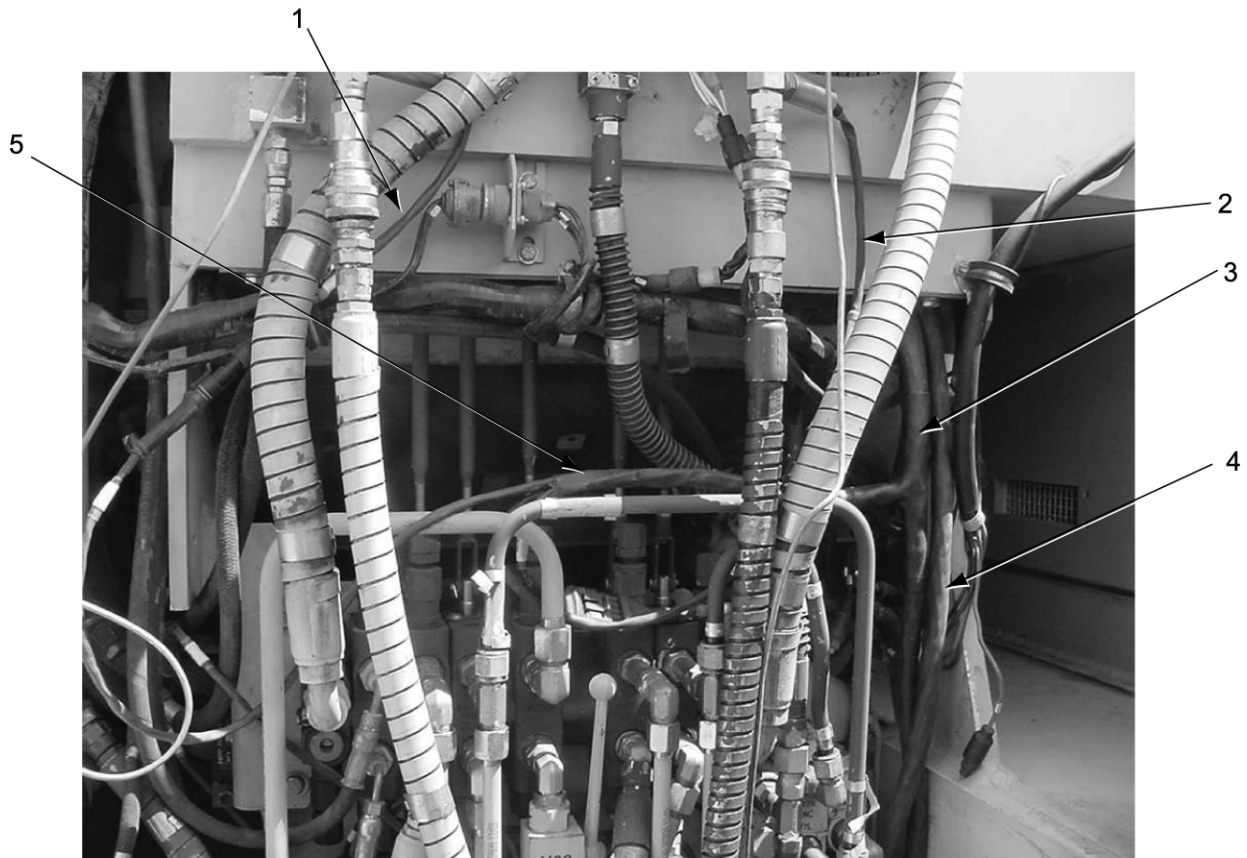

**Figure 5-4. Placement of Upper Cable Assembly W2**

### NOTE

Upper cable assembly W2 electrical connections are not made at this time. Upper cable assembly W2 connections to HDC solenoid valves and pressure transducers are performed in Section V.

## SECTION II INSTALLATION AND PRELIMINARY ROUTING OF HDC CABLE ASSEMBLIES - CONTINUED

### NOTE

Steps r and s below apply to Figure 5-5. Reference should also be made to FO 5-2.

- r. While standing in bowl area, uncoil single connector end J1 (2) of lower cable assembly W3, 12496955, (1) and feed cable assembly up through access cover opening in upper portion of bowl area (created by removal of access cover modified in Chapter 3, Section V) into driver's compartment in same manner as for upper cable assembly W2.
- s. Carefully route cable connector W3J1 up through access cover opening to back of umbilical cable disconnect bracket, 12496964, (3) as shown on Figure 5-5.

### NOTE

Step t below applies to FO 5-2.

- t. Orient large key (1) of cable connector W3J1 at 12 o'clock position and place in right most opening in umbilical cable disconnect bracket (3) as shown for a typical connector in Figure 5-2.

### FO 5-2. Lower Cable Assembly W3

## SECTION II INSTALLATION AND PRELIMINARY ROUTING OF HDC CABLE ASSEMBLIES - CONTINUED

### NOTE

Step u below applies to Figure 5-5.

- u. Allow lower cable assembly W3 (1) to hang down along left side of bowl area below DCV bank and primary manifold assembly, down near left main manifold assembly to underside of vehicle, as shown in Figure 5-5.



**Figure 5-5. Initial Placement of Lower Cable Assembly W3**

### NOTE

Lower cable assembly W3 electrical connections are not made at this time. Lower cable assembly W3 electrical connections to HDC solenoid valves and pressure transducers are performed in Section VI.

## SECTION II INSTALLATION AND PRELIMINARY ROUTING OF HDC CABLE ASSEMBLIES - CONTINUED

### NOTE

Steps v and w below apply to Figure 5-6. Reference should also be made to FO 5-3.

- v. From inside driver's compartment, uncoil single connector end J1 (3) of power cable assembly W1, 12496953, (1) and place as shown in Figure 5-6.
- w. Carefully place cable connector W1J1 near back of umbilical cable disconnect bracket, 12496964, (2).

### NOTE

It may be necessary to file a small notch in left most opening in umbilical cable disconnect bracket to allow the three "ears" on connector W1J1 to pass through opening in bracket.

### NOTE

Step x below applies to Figure 5-6.

- x. Orient large key (1) of cable connector W1J1 at 12 o'clock position and place in left most opening in umbilical cable disconnect bracket (3) as shown for a typical connector.

### FO 5-3. Power Cable Assembly W1

### NOTE

Step y below applies to Figure 5-6.

- y. Uncoil remainder of power cable assembly W1 and route 1070 branch of cable to parking brake relay area in front portion of driver's compartment.

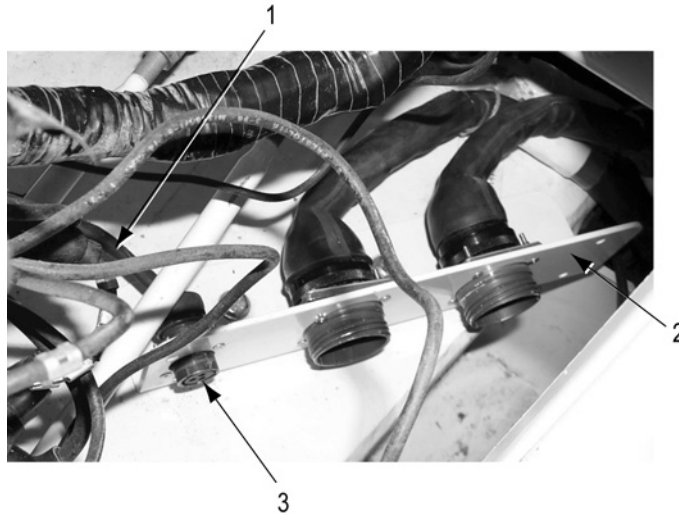

Figure 5-6. Initial Routing of Power Cable Assembly W1

## SECTION III ELECTRICAL CONNECTION OF HDC CIRCUIT BREAKER

### NOTE

Steps a through f below apply to Figure 5-7. Reference should also be made to FO 5-4.

- a. Access bank of circuit breakers in driver's compartment behind switch panel and gage panel.
- b. Remove existing lead labeled "10" from master relay, wiring harness 12357211, from right terminal of trailer receptacle and trouble light circuit breaker (1) shown in Figure 5-7. Refer also to FO 5-4 for an electrical schematic representation of the modification.



**Figure 5-7. Connection of HDC Power Distribution Components**

- c. Install in-line connector, 8741492, (2) in right terminal of trailer receptacle and trouble light circuit breaker (1), where wire lead was removed in step b above.
- d. Install "Y"-connector, 7982404, (5) on in-line connector (2) on trailer receptacle and trouble light circuit breaker (1).
- e. Attach previously removed wire lead, labeled "10," from master relay (4) to left side of "Y"-connector (5) installed in trailer receptacle and trouble light circuit breaker (1).
- f. Install lead assembly, 12496957, (3) between right side of "Y"-connector (5) attached to trouble light and trailer receptacles circuit breaker (1) and left terminal of HDC circuit breaker on umbilical cable disconnect bracket.

### SECTION III ELECTRICAL CONNECTION OF HDC CIRCUIT BREAKER - CONTINUED

#### NOTE

Wiring connections to parking brake relay should be made using screws attached to relay. New lockwashers should be used. If attaching screws are damaged or missing, obtain new screws locally.

#### NOTE

Step g below applies to Figure 5-8. Reference should also be made to FO 5-4.

- g. Connect lead assembly, 12496958, (labeled 1070) between right terminal of HDC circuit breaker on umbilical cable disconnect bracket and terminal B2 (lower right terminal) on parking brake relay. New lockwashers should be used on parking brake relay terminals. Refer to Figure 5-8.

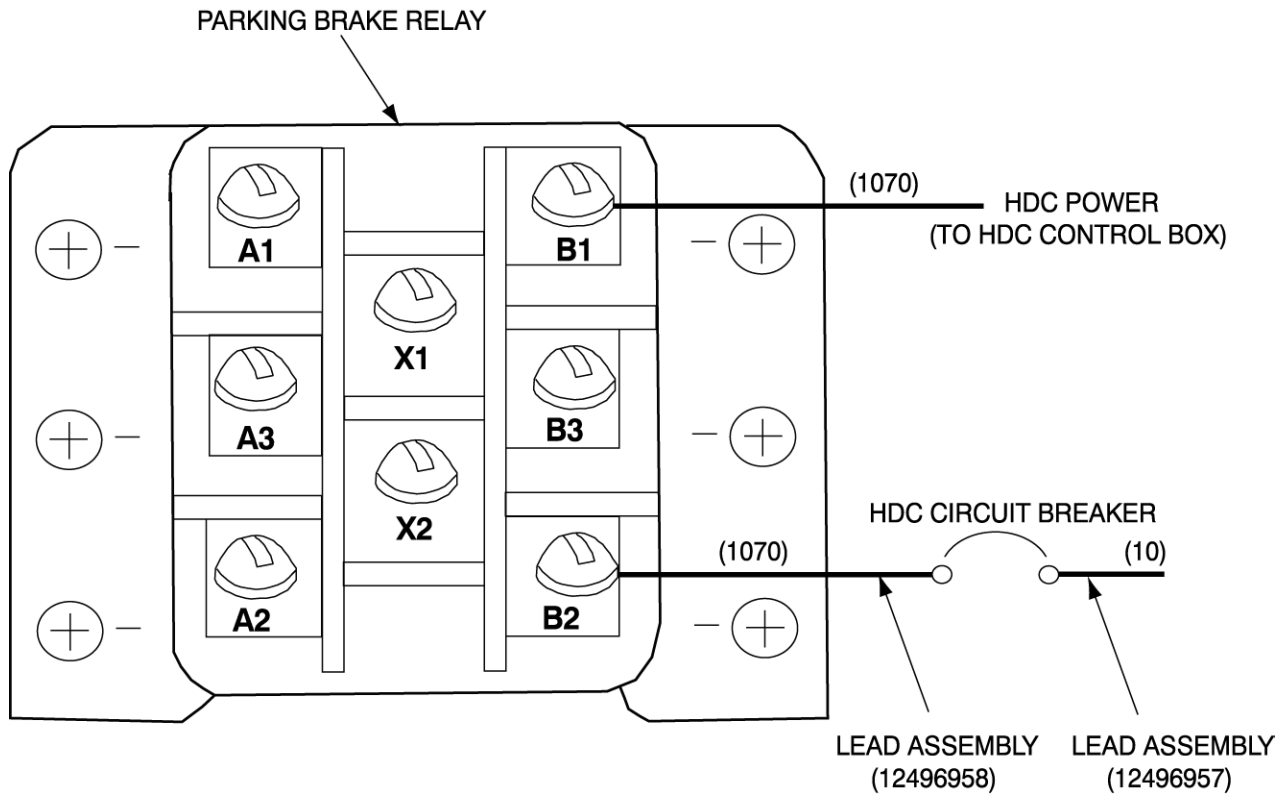

Figure 5-8. Parking Brake Relay Terminals



## SECTION IV ROUTING AND ELECTRICAL CONNECTION OF POWER CABLE ASSEMBLY W1

### NOTE

One branch of cable assembly W1 connects to parking brake relay terminal B1 to provide DC power to operate HDC System; the other branch provides a negative (-) electrical connection.

### NOTE

Steps a and b below apply to Figure 5-9.

- a. Attach 1070 branch of cable W1 to parking brake relay terminal B1 (upper right terminal).
- b. Secure 1070 branch of cable W1.

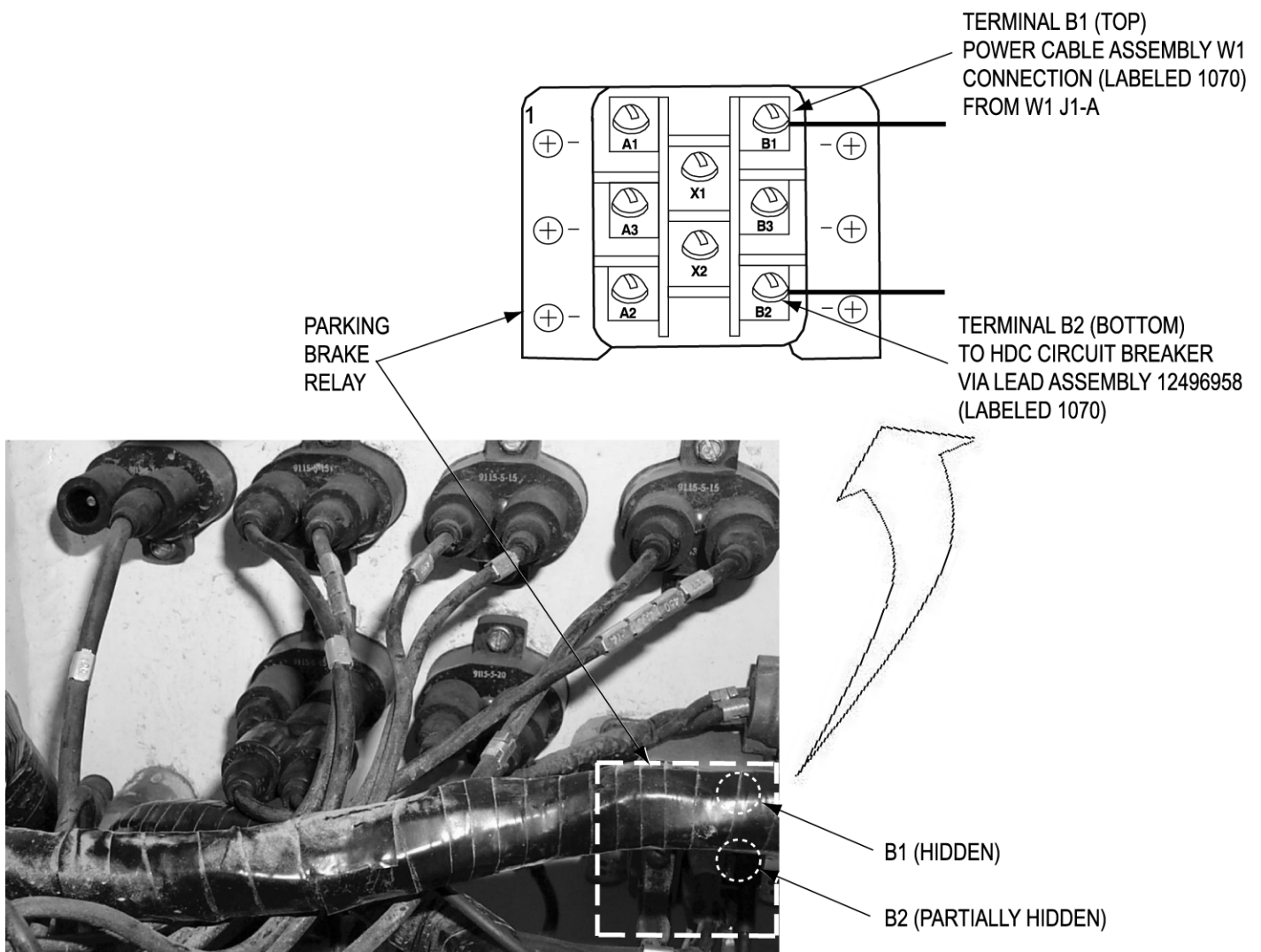

Figure 5-9. HDC Power Cable Assembly W1 Connection to Parking Brake Relay

## SECTION IV ROUTING AND ELECTRICAL CONNECTION OF POWER CABLE ASSEMBLY W1 - CONTINUED

### NOTE

Step c below applies to Figures 5-10 and 5-11.

- c. Route 1069 branch of cable W1 from disconnect bracket to the wall of the operator's compartment just above the NBC filter, as shown in Figures 5-10 and 5-11.
- d. Cut excess cable, install terminal lug, MS25035-154, and crimp onto end of cable W1.
- e. Remove bolt along with existing ground wires from compartment wall. Do not remove existing ground wires from bolt.
- f. Install 1069 branch of cable W1 on end of bolt and reinstall bolt with wires to compartment wall as shown in Figure 5-11.
- g. Secure 1069 branch of cable W1 wiring to vehicle as necessary using tiedown straps, MS3367-1-9, and by routing cable through existing cable clamps. It is not necessary to remove cable clamps during cable routing process.



CABLE ASSEMBLY W1  
BRANCH 1069 FROM  
DISCONNECT BRACKET

**Figure 5-10. Routing Cable Assembly W1 Branch 1069 From Disconnect Bracket**

## SECTION IV ROUTING AND ELECTRICAL CONNECTION OF POWER CABLE ASSEMBLY W1 - CONTINUED



Figure 5-11. Routing Cable Assembly W1 Branch 1069 to Compartment Wall

## **SECTION IV ROUTING AND ELECTRICAL CONNECTION OF POWER CABLE ASSEMBLY W1 - CONTINUED**

### **NOTE**

Ensure HDC electrical components and cable assembly W1 wiring has been installed in accordance with simplified electrical schematic diagram shown in FO 5-4.

**FO 5-4. Simplified Electrical Schematic Diagram of HDC System Power Distribution**

## SECTION V ROUTING AND ELECTRICAL CONNECTION OF UPPER CABLE ASSEMBLY W2

### CAUTION

It is important that all W2 cable assembly branches and individual electrical connectors be routed and dressed close to primary manifold behind hydraulic tubes and close to rear wall of bowl to protect cable from possible damage.

### NOTE

Steps a through h apply to Figure 5-12. Reference should also be made to FO 5-5.

- a. Route two branches of cable upper assembly W2 (2) to proper portions of bowl area. Upper area electrical cable connectors P3, P4, and P30 branch out from one leg of W2 and mate with electrical connectors in the main pump hydraulic filter area and near the suspension valve. All other W2 cable connectors branch from other leg of W2 and mate with electrical connectors on HDC primary manifold, except for connector W2P7 that mates with pressure transducer T7 on left main manifold, at bottom of bowl area. Note that lower cable assembly W3 (1) runs parallel to upper cable assembly W2 (2) down left side of ejector bowl.
- b. Secure upper portion of cable assembly W2 to vehicle as necessary using tiedown straps, MS3367-1-9, and existing cable clamps as required.
- c. Carefully route branch of upper cable assembly W2 (with connectors P3, P4, and P30) to main pump left and right high-pressure hydraulic filter area and suspension valve as shown in Figure 5-12.



Figure 5-12. Upper Cable Assembly W2 Routing

## SECTION V ROUTING AND ELECTRICAL CONNECTION OF UPPER CABLE ASSEMBLY W2 - CONTINUED

- d. Dress upper portion of cable assembly W2 into filter area as shown in Figure 5-12 and make electrical connections: W2P3 to connector on pressure transducer T3, W2P4 to connector on pressure transducer T4, and W2P30 to connector on pressure transducer T12, as indicated in FO 5-5 and Table 5-3.
- e. Secure main filter area branches of cable W2 to vehicle as necessary using tiedown straps.

**Table 5-1. Upper Cable Assembly W2 Electrical Connections**

W2 PLUG	MATES WITH	COMPONENT LOCATION	REFERENCE/NOTES
W2P1	Solenoid Valve V1	Primary Manifold	Figure 5-13, Shutoff Valve (normally open)
W2P2	Pressure Transducer T2	Primary Manifold	Figure 5-13
W2P3	Pressure Transducer T3	Near Left Main Pump Filter	Figure 3-42
W2P4	Pressure Transducer T4	Near Right Main Pump Filter	Figure 3-42
W2P5	Solenoid Valve V5	Primary Manifold	Figure 5-13, (three-way valve)
W2P6 (Does not exist)	N/A	N/A	N/A
W2P7	Pressure Transducer T7	Left Main Manifold	Figure 3-23
W2P8 (Does not exist)	N/A	N/A	N/A
W2P9 (Does not exist)	N/A	N/A	N/A
W2P10 (Does not exist)	N/A	N/A	N/A
W2P11	Solenoid Valve V11	Primary Manifold	Figure 5-13, (three-way valve)
W2P12	Solenoid Valve V12	Primary Manifold	Figure 5-13, Shutoff Valve (normally open)
W2P13	Solenoid Valve V13	Primary Manifold	Figure 5-13, Shutoff Valve (normally open)
W2P14	Solenoid Valve V14	Primary Manifold	Figure 5-13, (three-way valve)
W2P15	Solenoid Valve V15	Primary Manifold	Figure 5-13, (three-way valve)
W2P16	Solenoid Valve V16	Primary Manifold	Figure 5-13, (three-way valve)
W2P17	Solenoid Valve V17	Primary Manifold	Figure 5-13, (three-way valve)

## SECTION V ROUTING AND ELECTRICAL CONNECTION OF UPPER CABLE ASSEMBLY W2 - CONTINUED

Table 5-1. Upper Cable Assembly W2 Electrical Connections - Continued.

W2 PLUG	MATES WITH	COMPONENT LOCATION	REFERENCE/ NOTES
W2P18 (Does not exist)	N/A	N/A	N/A
W2P19	Solenoid Valve V19	Primary Manifold	Figure 5-13, Shutoff Valve (normally closed)
W2P20	Solenoid Valve V20	Primary Manifold	Figure 5-13, Shutoff Valve (normally closed)
W2P21 (Does not exist)	N/A	N/A	N/A
W2P22 (Does not exist)	N/A	N/A	N/A
W2P23 (Does not exist)	N/A	N/A	N/A
W2P24 (Does not exist)	N/A	N/A	N/A
W2P25 (Does not exist)	N/A	N/A	N/A
W2P26 (Does not exist)	N/A	N/A	N/A
W2P27 (Does not exist)	N/A	N/A	N/A
W2P28 (Does not exist)	N/A	N/A	N/A
W2P29 (Does not exist)	N/A	N/A	N/A
W2P30	Pressure Transducer T12	Near Suspension (Spring/Unsprung) Valve	Figure 3-43
W2P31	Pressure Transducer T1	Primary Manifold	Figure 5-13
W2P32	Pressure Transducer T13	Primary Manifold	Figure 5-13

## SECTION V ROUTING AND ELECTRICAL CONNECTION OF UPPER CABLE ASSEMBLY W2 - CONTINUED

- f. Carefully route branch of upper cable assembly W2 (3) to HDC primary manifold portion of the bowl area.
- g. Dress upper cable assembly W2 branch into lower bowl area and make electrical connections to primary manifold assembly as indicated in FO 5-5, Figure 5-13, and Table 5-1.
- h. Secure branch of cable W2 assembly to vehicle as necessary using tiedown straps, MS3367-1-9, and existing cable clamps.



Figure 5-12. Upper Cable Assembly W2 Routing

FO 5-5. HDC System Electrical Interconnection Diagram



### SECTION V ROUTING AND ELECTRICAL CONNECTION OF UPPER CABLE ASSEMBLY W2 - CONTINUED

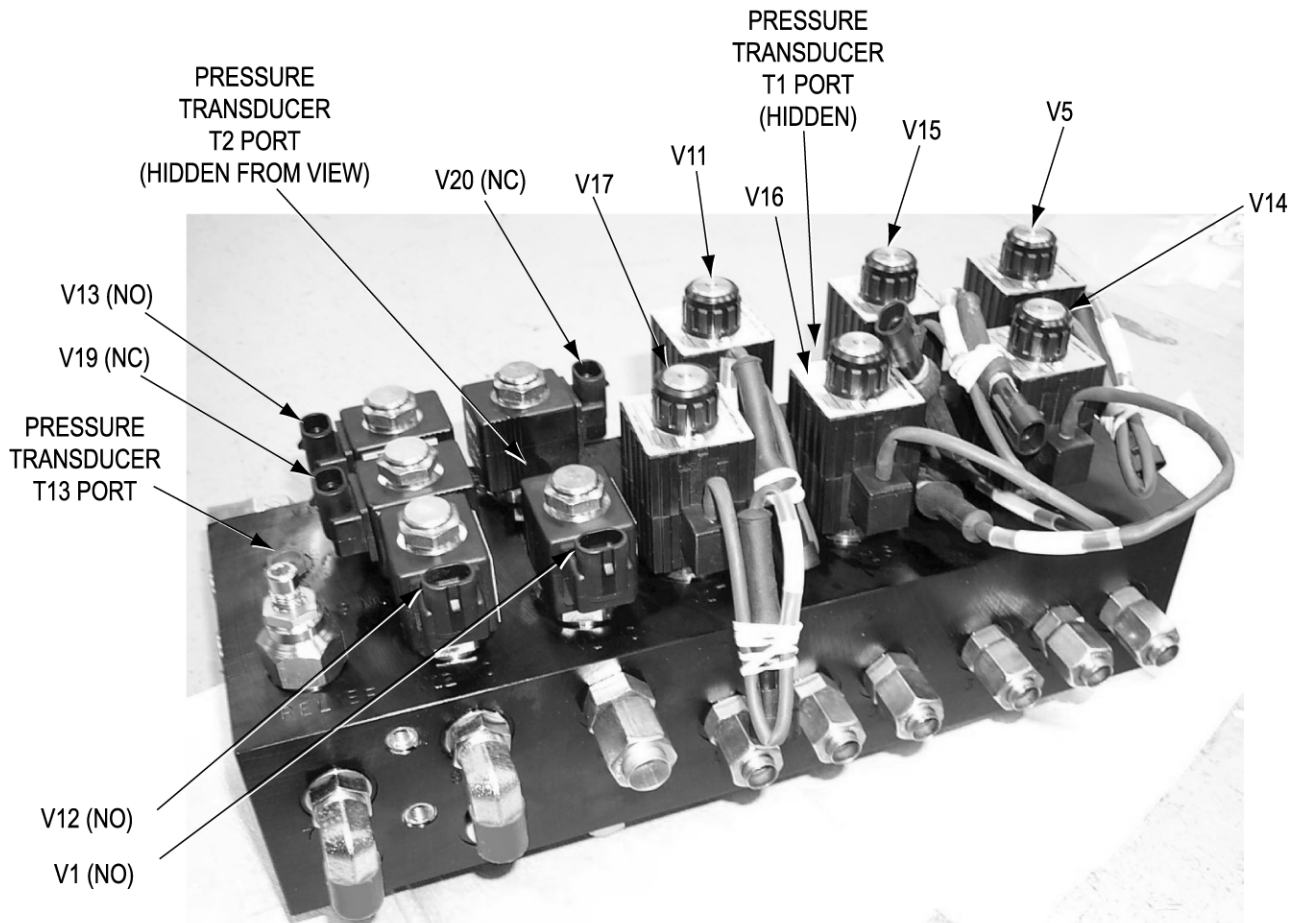

Figure 5-13. Electrical Connections on Primary Manifold Assembly

## SECTION VI ROUTING AND ELECTRICAL CONNECTION OF LOWER CABLE ASSEMBLY W3

### NOTE

Steps a and b below apply to Figure 5-14. Reference should also be made to FO 5-5.

- a. Cable assembly W3, Figure 5-14, (2), is routed down the left lower side of ejector bowl and down behind left main manifold as shown in Figure 5-14. Upper cable assembly W2 (1) is routed toward the primary manifold assembly just above the left main manifold.
- b. Route three branches of cable W3 to proper areas on underside of vehicle. One main branch of W3 cable interfaces with components on left underside of vehicle while other main branch of cable W3 interfaces with components on right underside of vehicle. There are three smaller branches on each W3 main cable branches.

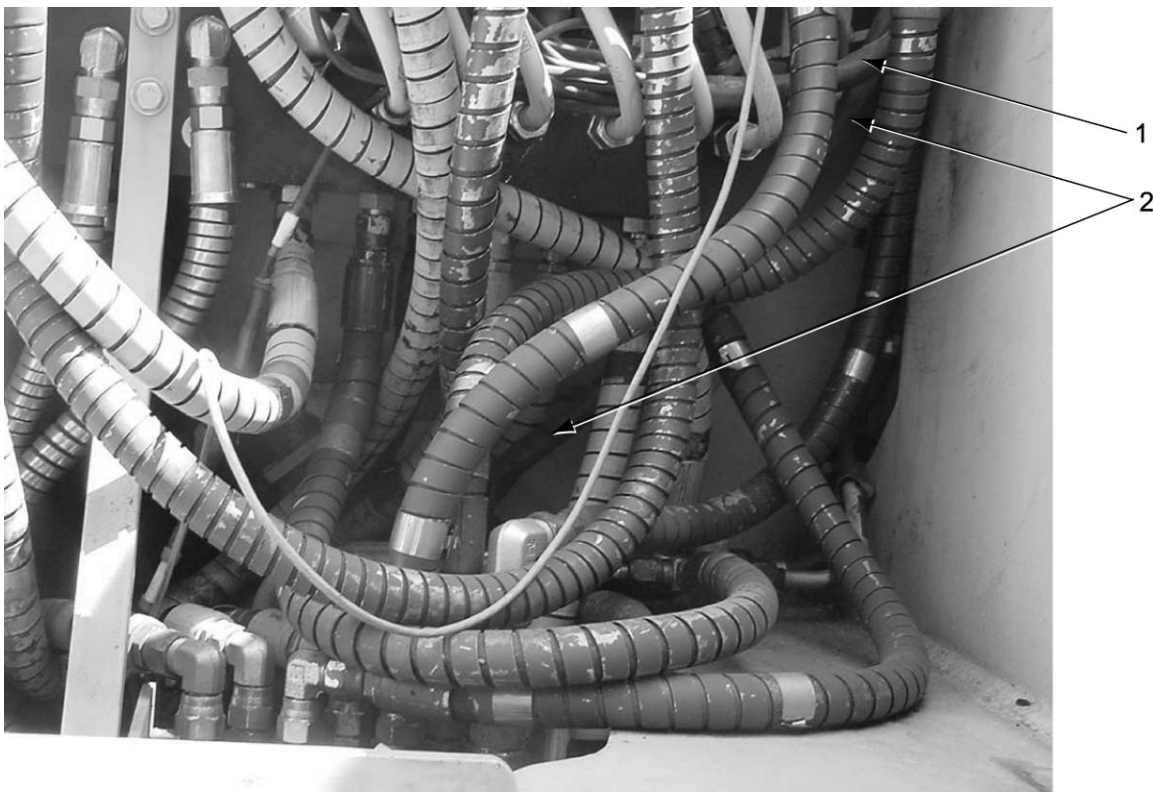

Figure 5-14. Lower Cable Assembly W3 Routing

## SECTION VI ROUTING AND ELECTRICAL CONNECTION OF LOWER CABLE ASSEMBLY W3 - CONTINUED

### NOTE

Steps c and d below apply to Figures 5-15 through 5-17. Reference should also be made to FO 5-5.

- c. Dress lower cable assembly W3 branches on underside of vehicle and make electrical connection to assemblies and components as indicated in Table 5-2.
- d. Secure lower cable assembly W3 to vehicle as necessary using tiedown straps, MS3367-1-9, and existing cable clamps.

**Table 5-2. Lower Cable Assembly W3 Electrical Connections**

W3 PLUG	MATES WITH	COMPONENT LOCATION	REFERENCE/ NOTES
W3P1 (Does not exist)	N/A	N/A	N/A
W3P2	Solenoid Valve V2	Forward Right Manifold	Figure 5-16
W3P3	Solenoid Valve V3	Forward Left Manifold	Figure 5-15, Shutoff Valve (normally open)
W3P4	Solenoid Valve V4	Aft Manifold	Figure 5-17, Shutoff Valve (normally open)
W3P5	Pressure Transducer T5	Forward Right Actuator #1	Figure 3-48
W3P6	Solenoid Valve V6	Aft Manifold	Figure 5-17, Shutoff Valve (normally open)
W3P7	Solenoid Valve V7	Aft Manifold	Figure 5-17, Shutoff Valve (normally open)
W3P8	Solenoid Valve V8	Aft Manifold	Figure 5-17, Shutoff Valve (normally open)
W3P9	Solenoid Valve V9	Forward Left Manifold	Figure 5-15, Shutoff Valve (normally open)
W3P10	Solenoid Valve V10	Forward Right Manifold	Figure 5-16
W3P11	Pressure Transducer T11	Forward Right Manifold	Figure 5-16
W3P12 (Does not exist)	N/A	N/A	N/A
W3P13 (Does not exist)	N/A	N/A	N/A
W3P14 (Does not exist)	N/A	N/A	N/A
W3P15 (Does not exist)	N/A	N/A	N/A
W3P16 (Does not exist)	N/A	N/A	N/A
W3P17 (Does not exist)	N/A	N/A	N/A

## SECTION VI ROUTING AND ELECTRICAL CONNECTION OF LOWER CABLE ASSEMBLY W3 - CONTINUED

Table 5-2. Lower Cable Assembly W3 Electrical Connections - Continued

W3 PLUG	MATES WITH	COMPONENT LOCATION	REFERENCE/ NOTES
W3P18	Solenoid Valve V18	Aft Manifold	Figure 5-17, Shutoff Valve (normally open)
W3P19 (Does not exist)	N/A	N/A	N/A
W3P20 (Does not exist)	N/A	N/A	N/A
W3P21 (Does not exist)	N/A	N/A	N/A
W3P22 (Does not exist)	N/A	N/A	N/A
W3P23 (Does not exist)	N/A	N/A	N/A
W3P24 (Does not exist)	N/A	N/A	N/A
W3P25 (Does not exist)	N/A	N/A	N/A
W3P26 (Does not exist)	N/A	N/A	N/A
W3P27 (Does not exist)	N/A	N/A	N/A
W3P28 (Does not exist)	N/A	N/A	N/A
W3P29 (Does not exist)	N/A	N/A	N/A
W3P30	Pressure Transducer T10	Forward Left Manifold	Figure 5-15
W3P31	Pressure Transducer T6	Forward Left Actuator #1	Figure 3-49
W3P32	Pressure Transducer T9	Left Side Underneath Sprung Stop Cylinder	Figure 3-49
W3P33	Pressure Transducer T8	Right Side Underneath Sprung Stop Cylinder	Figure 3-48

## SECTION VI ROUTING AND ELECTRICAL CONNECTION OF LOWER CABLE ASSEMBLY W3 - CONTINUED

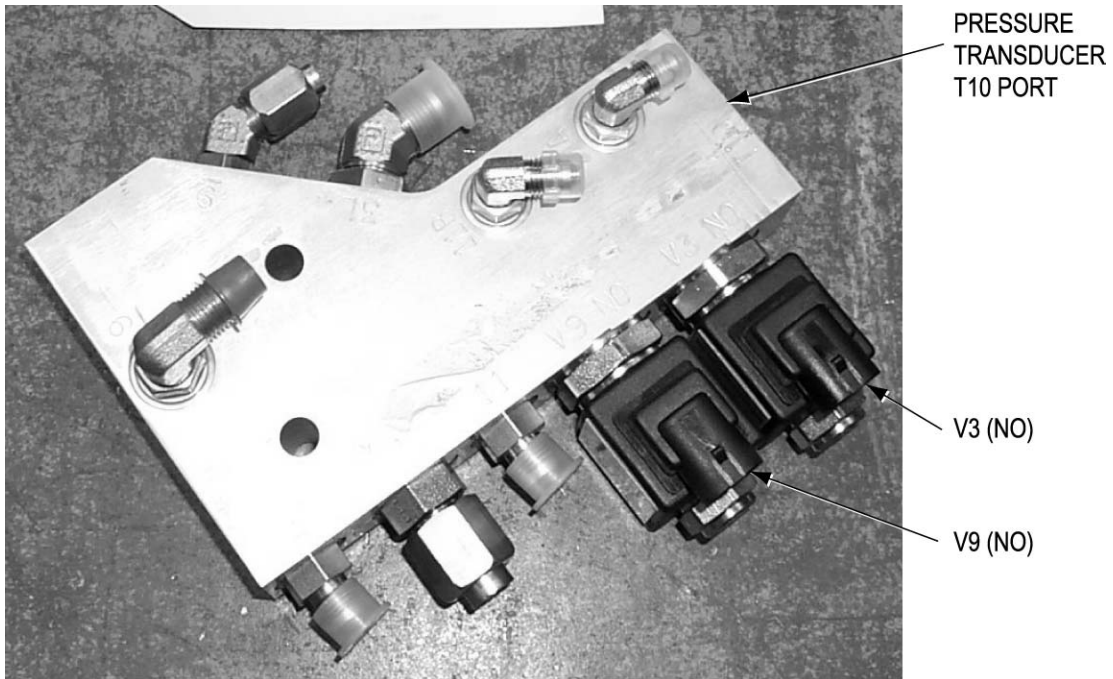

Figure 5-15. Electrical Connections on Forward Left Manifold Assembly

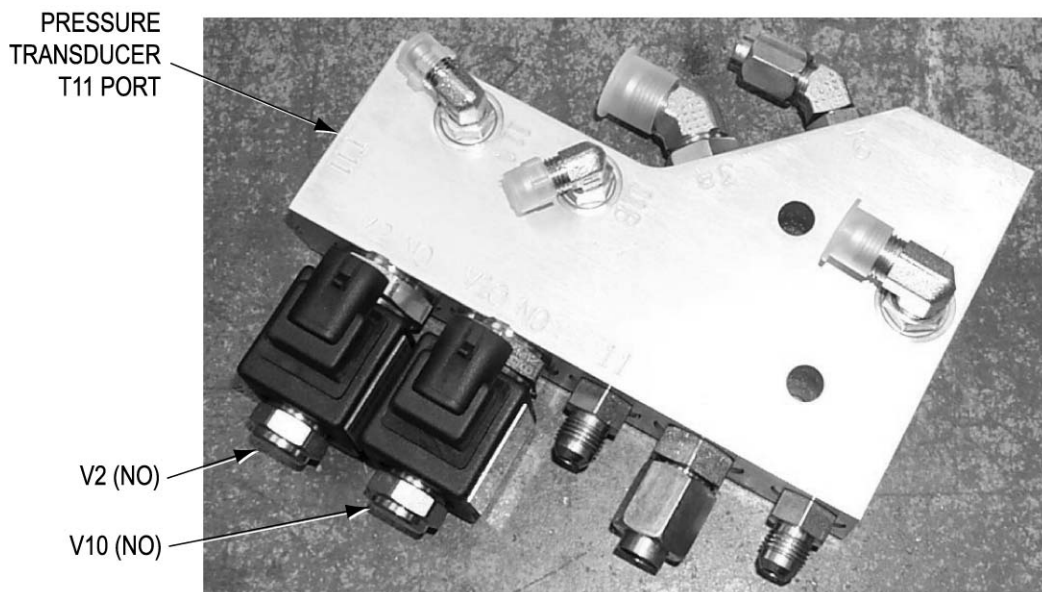

Figure 5-16. Electrical Connections on Forward Right Manifold Assembly

### SECTION VI ROUTING AND ELECTRICAL CONNECTION OF LOWER CABLE ASSEMBLY W3 - CONTINUED

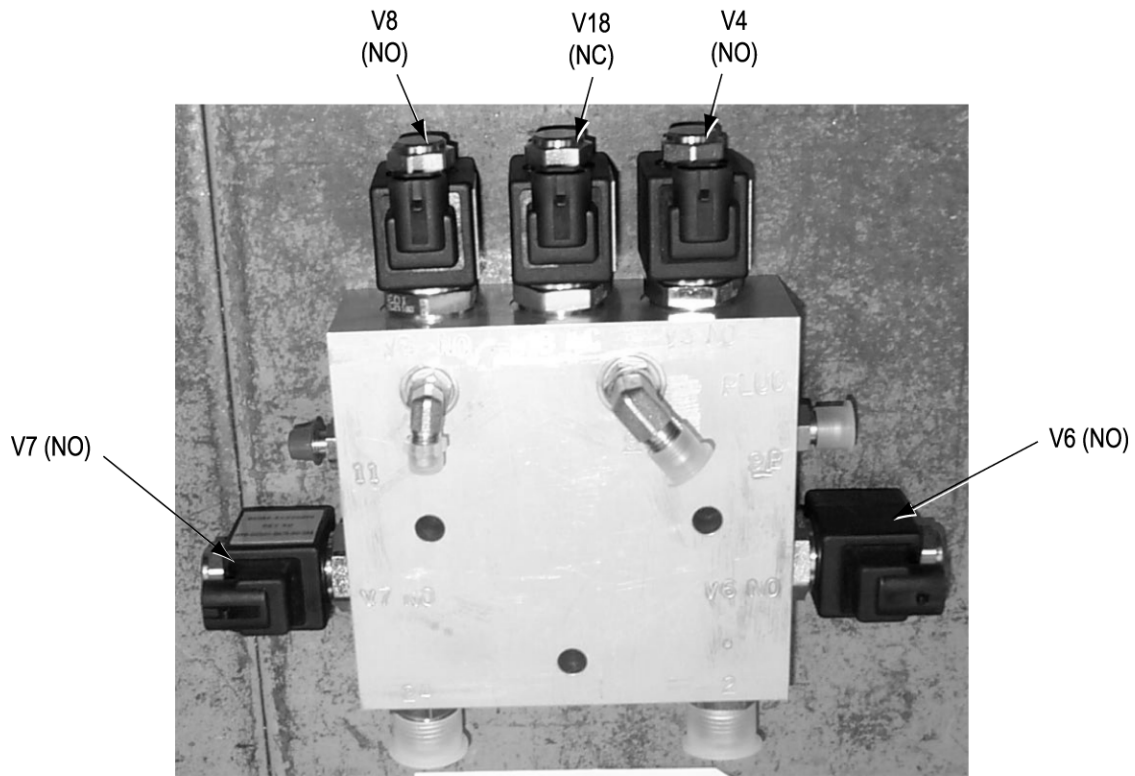

Figure 5-17. Electrical Connections on Aft Manifold Assembly

## SECTION VII MODIFICATION COMPLETION

### NOTE

After all HDC modifications have been made, a thorough check should be made throughout the vehicle to ensure that all vehicle components that were temporarily moved to facilitate the modification have been re-installed, and that the vehicle is ready for normal operation.

### NOTE

Steps a through e below apply to figures in M9 ACE TM 5-2350-262 series of technical manuals.

- a. Secure previously moved switch panel (Driver's Instrument Panel) in front area of driver's compartment per TM 5-2350-262-20-1.
- b. Reinstall driver's seat using four new self-locking screws, B1821BH038C100L. Refer to TM 5-2350-262-20-2.
- c. Reinstall parking brake lever using two new self-locking nuts, MS17829-5C. Refer to TM 5-2350-262-20-1.
- d. Tighten two mounting screws on umbilical cable disconnect bracket that were not tightened in Chapter 2, Section IV, step g.
- e. Connect vehicle battery power per TM 5-2350-262-20-1, Battery Cable Replacement, Negative Cables Connect.

## SECTION VII MODIFICATION COMPLETION - CONTINUED

### NOTE

Step f below applies to Figure 5-18.

- f. Reinstall access cover, 12332229, (1) (cover that was trimmed), in bowl area using three new self-locking bolts, MS51095-360L, (3), and three saved flat washers (2). Tighten self-locking bolts as specified. Refer to TM 5-2350-262-20-1, Hull Access Covers and Plug Replacement and Repair procedure.
- g. Reinstall left and right actuator access panels in frames using four saved machine bolts per TM 5-2350-262-20-1, Actuator Access Plates Replacement.
- h. If not previously accomplished, install four hull access covers on bottom of hull per TM 5-2350-262-20-1, Hull Access Covers and Plug Replacement and Repair.
- i. If previously removed, install ejector on vehicle per TM 5-2350-262-20-1, Ejector Replacement.
- j. Ensure that vehicle is completely reassembled and apparently ready to resume normal operation.
- k. Refer to TM 5-2350-262-10 and perform applicable operating procedures to ensure vehicle is fully mission capable.

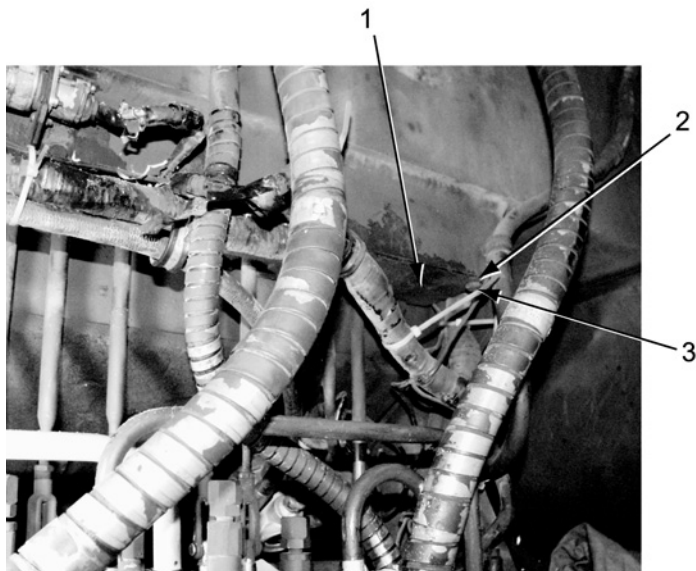

Figure 5-18. Access Cover Location



## SECTION VII MODIFICATION COMPLETION - CONTINUED

### NOTE

Step I below applies to Figure 5-19.

- I. Remove HDC control box from stowage fixture and obtain umbilical cable assembly W4 from shipping container.
- m. Perform M9 ACE MWO Check-Out Procedure in Appendix A to ensure HDC system operates properly and is transparent to normal vehicle operations and functions.
- n. If HDC system does not power up, recheck electrical installation.
- o. If electrical installation has been performed properly, and all wiring properly connected, and system still does not power up or portions of HDC electrical system do not appear to be operating properly, refer to HDC troubleshooting procedures in TM 5-2350-378-24&P.

#### FO 5-6. Umbilical Cable Assembly W4



Figure 5-19. HDC Control Box

## SECTION VII MODIFICATION COMPLETION - CONTINUED



Figure 5-20. Umbilical Cable Assembly W4 Connection to Umbilical Cable Disconnect Bracket

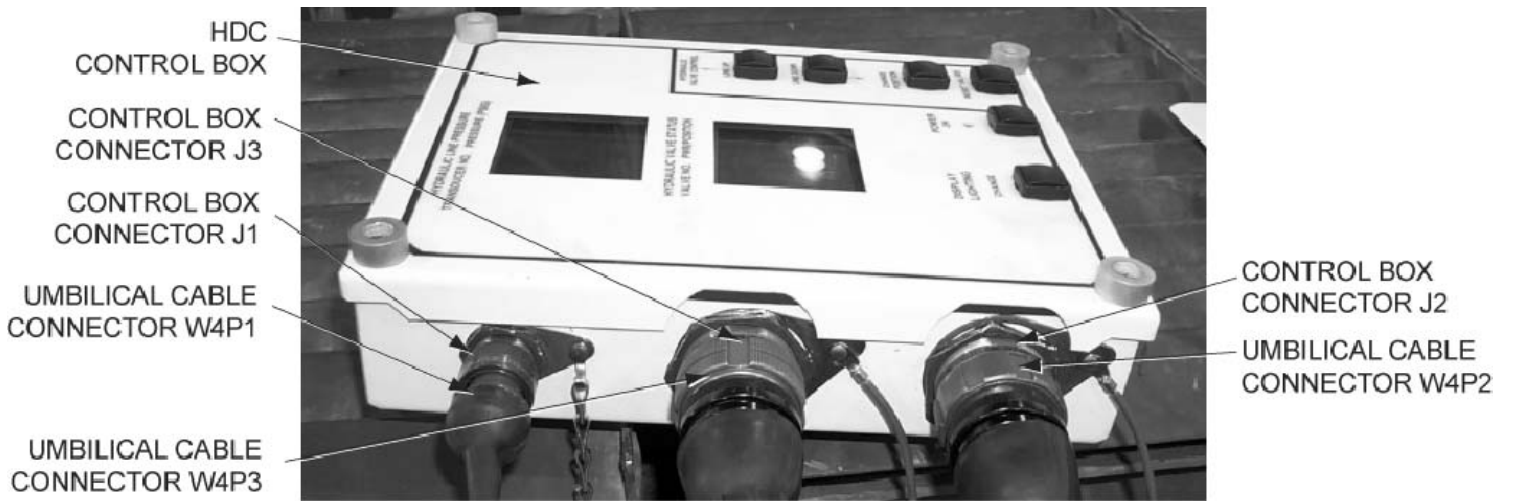

Figure 5-21. Umbilical Cable Assembly W4 Connections to HDC Control Box

## **APPENDIX A M9 ACE HDC MWO CHECK-OUT PROCEDURE**

### **PURPOSE:**

The purpose of the M9 ACE HDC MWO Check-out Procedure is to ensure that the installation of the HDC has been completed correctly, and that the vehicle and the HDC function properly.

### **ASSUMPTIONS:**

1. Vehicle relief valve settings have previously been adjusted in accordance with TM-5-2350-262-20-3, using a GS-5 pressure gage, with a tolerance of +/- 100 psi.
2. The accuracy of the HDC is +/- 100 psi.
3. During the Product Acceptance Testing, values within +/- 200 psi are considered within specification.
4. Other vehicle operational characteristics meet the specifications of TM-5-2350-262-20-3.

### **PROCEDURE:**

The tests shall be conducted in accordance with this procedure. The HDC system is considered fully operational when it has passed all of the tests.

### **WARNING**

Before performing any troubleshooting in bowl, move the ejector forward and disconnect the ejector cylinder from the hydraulic system by pulling the handle down on ball valve V23, located in the rear of the bowl area, just below the main control valve bank. Failure to comply may result in severe injury or death to personnel.

1. Exercise vehicle functions:
  - a) Confirm that the three HDC manual valves are in the OPEN position. (Handles must be vertical.)
  - b) Start engine.
  - c) Vehicle must rise up and level out normally when the engine is started.
  - d) Confirm that ejector extends and retracts.
  - e) Confirm that apron moves up and down.
  - f) Confirm that left suspension moves up and down.
  - g) Confirm that right suspension moves up and down.
  - h) Confirm that the left and right bump stops extend when the vehicle is placed in SPRUNG mode, and retract when the vehicle is placed in UNSPRUNG mode.
  - i) Confirm that winch pays out and pays in.

**APPENDIX A  
M9 ACE HDC  
MWO CHECK-OUT PROCEDURE - CONTINUED**

2. Valve V23 check:

- a) Stop engine.
- b) Place valve V23 in the closed position. (Handle horizontal.)
- c) Start engine.
- d) Confirm that the ejector does not extend or retract. (This indicates that V23 is working properly.)
- e) Stop engine and ensure that engine is off before connecting HDC control box.

3. Control box power-up:

**CAUTION**

Do not activate the vehicle's hydraulic control levers or depress any buttons on the HDC control box unless directed by this procedure. Failure to follow this caution may cause equipment damage.

**NOTE**

Steps a and b below apply to Figures 5-20 and 5-21.

- a) Connect umbilical cable assembly connector W4P4 to connector W1J1 on umbilical cable disconnect panel, connector W4P5 to connector W2J1 on umbilical cable disconnect panel, and connector W4P6 to connector W3J1 on umbilical cable disconnect panel as shown.
- b) Connect three connectors on other end of umbilical cable assembly W4 to HDC control box as shown in Figure 5-18. Connect umbilical cable assembly connector W4P1 to connector J1 on HDC control box, connector W4P2 to connector J2 on HDC control box, and connector W4P3 to connector J3 on control box.
- c) Power up the HDC control box by pressing the POWER button.
- d) Confirm that the control box displays the transducer number, pressure, valve number, valve status (PWR), and valve position status similar to Table A-1. (Note: a CIRCUIT FAULT message indicates a disconnected wire harness or defective component. Check all connections in the event of a CIRCUIT FAULT message).

**APPENDIX A  
M9 ACE HDC  
MWO CHECK-OUT PROCEDURE - CONTINUED**

**TABLE A-1**

VALVE NO.	PWR	/	POSITION
V1	OFF	/	OPEN
V2	OFF	/	OPEN
V3	OFF	/	OPEN
V4	OFF	/	OPEN
V5	OFF	/	OPEN
V6	OFF	/	OPEN
V7	OFF	/	OPEN
V8	OFF	/	OPEN
V9	OFF	/	OPEN
V10	OFF	/	OPEN
V11	OFF	/	OPEN
V12	OFF	/	OPEN
V13	OFF	/	OPEN
V14	OFF	/	OPEN
V15	OFF	/	OPEN
V16	OFF	/	OPEN
V17	OFF	/	OPEN
V18	OFF	/	CLOSED
V19	OFF	/	CLOSED
V20	OFF	/	CLOSED

4. Transducer T7, T8, T9, T10, T11, T12, and T13 check:

- a) Have the vehicle operator move the SPRUNG/UNSPRUNG lever to the UNSPRUNG position.
- b) With the vehicle running, confirm that T7, T8, T9, T10, T11, T12, and T13 read greater than 2500 psig. (This is the pressure provided by the compensating pump, and it indicates that transducers T7 through T13 are working properly.)

5. Transducer T5 check:

- a) Push the RESET VALVES button on the control box, and verify all the valves are set to the power OFF setting and are in the default position. Reference Table A-1.
- b) Verify that the SPRUNG/UNSPRUNG lever is in the UNSPRUNG position.
- c) Have the vehicle operator move the right SUSPENSION CONTROL lever to the RAISE position, and hold it there until the vehicle reaches the maximum height.
- d) Verify that the pressure reading for T5 is at least 2,800 psig. (T5 is now reading the pressure setting of the right suspension relief valve, and indicates that transducer T5 is working properly.)
- e) Have the vehicle operator release the right SUSPENSION CONTROL lever.

**APPENDIX A  
M9 ACE HDC  
MWO CHECK-OUT PROCEDURE - CONTINUED**

6. Transducer T6 check:

- a) Push the RESET VALVES button and verify all the valves are set to the power OFF setting and are in the default position. Reference Table A-1.
- b) Verify that the SPRUNG/UNSPRUNG lever is in the UNSPRUNG position.
- c) Have the vehicle operator move the left SUSPENSION CONTROL lever to the RAISE position, and hold it there until the vehicle reaches the maximum height.
- d) Verify that the pressure reading for T6 is greater than 2,800 psig. (T6 is now reading the pressure setting of the left suspension relief valve, and indicates that transducer T6 is working properly.)
- e) Have the vehicle operator release the left SUSPENSION CONTROL lever.

7. Valve V21 and transducer T3 check:

- a) Push the RESET VALVES button on the control box, and verify all the valves are set to the power OFF setting and are in the default position. Reference Table A-1.
- b) Slowly close ball valve V21 until the pressure reading on T3 display exceeds 3,000 psig. (This indicates that V21 and T3 are both working properly.)
- c) Open ball valve V21.

8. Valve V22 and transducer T4 check:

- a) Push the RESET VALVES button on the control box, and verify all the valves are set to the power OFF setting and are in the default position. Reference Table A-1.
- b) Slowly close ball valve V22 until the pressure reading on T4 display exceeds 3,000 psig. (This indicates that V22 and T4 are both working properly.)
- c) Open ball valve V22.

9. Reserved

10. Reserved

11. Valve V5 and transducer T1 check:

- a) Push the RESET VALVES button on the control box, and verify all the valves are set to the power OFF setting and are in the default position. Reference Table A-1.
- b) Have the vehicle operator place the vehicle in UNSPRUNG mode.
- c) Use the LINE UP and LINE DOWN buttons to select valve V5. Press CHANGE POSITION to close valve V5.

**APPENDIX A**  
**M9 ACE HDC**  
**MWO CHECK-OUT PROCEDURE - CONTINUED**

- d) Have the vehicle operator move the right SUSPENSION CONTROL lever to LOWER. Verify that the right suspension does NOT lower, and that Transducer T1 reads greater than 3500 psi. (This indicates that valve V5 has redirected flow from the suspension to transducer T1, which will now read the value of the system relief valves.)

12. Valve V9 and V10 check:

- a) Push the RESET VALVES button on the control box, and verify all the valves are set to the power OFF setting and are in the default position. Reference Table A-1.
- b) Have the vehicle operator place the vehicle in SPRUNG mode.
- c) Verify that the bump stops are extended.
- d) Use the LINE UP and LINE DOWN buttons to select valve V9. Press CHANGE POSITION to close valve V9.
- e) Use the LINE UP and LINE DOWN buttons to select valve V10. Press CHANGE POSITION to close valve V10.
- f) Have the vehicle operator place the vehicle in the UNSPRUNG mode.
- g) Verify that the bump stops are still extended. (This indicates that V9 and V10 are closed, preventing operation of the bump stops.)
- h) Push the RESET VALVES button on the control box, and verify all the valves are set to the power OFF setting and are in the default position. Reference Table A-1.
- i) Verify that the bump stops are now retracted. (This verifies that V9 and V10 have opened.)

13. Valve V11 check:

- a) Push the RESET VALVES button on the control box, and verify all the valves are set to the power OFF setting and are in the default position. Reference Table A-1.
- b) Have the vehicle operator place the vehicle in SPRUNG mode.
- c) Use the LINE UP and LINE DOWN buttons to select valve V11. Press CHANGE POSITION to close valve V11.
- d) Verify that transducer T1 reads less than 500 psig.
- e) Have the vehicle operator place the vehicle in UNSPRUNG mode.
- f) Have the vehicle operator move the left SUSPENSION CONTROL lever to LOWER.
- g) Verify that transducer T1 reads greater than 3000 psig. (This indicates that V11 has directed flow from the suspension to transducer T1, which now reads the system relief valve pressure setting.)

14. Reserved

**APPENDIX A  
M9 ACE HDC  
MWO CHECK-OUT PROCEDURE - CONTINUED**

15. Valve V14 check:

- a) Push the RESET VALVES button on the control box, and verify all the valves are set to the power OFF setting and are in the default position. Reference Table A-1.
- b) Use the LINE UP and LINE DOWN buttons to select valve V14. Press CHANGE POSITION to close valve V14.
- c) Have the vehicle operator move the winch control lever to PAY OUT until transducer T1 reads less than 500 psig.
- d) Have the vehicle operator move the winch control lever to PAY IN until transducer T1 reads greater than 1500 psig. (This indicates that V14 has directed flow from the winch circuit to transducer T1.)

16. Valve V15 check:

- a) Push the RESET VALVES button on the control box, and verify all the valves are set to the power OFF setting and are in the default position. Reference Table A-1.
- b) Use the LINE UP and LINE DOWN buttons to select valve V15. Press CHANGE POSITION to close valve V15.
- c) Have the vehicle operator move the right SUSPENSION CONTROL lever to LOWER until transducer T1 reads less than 500 psig.
- d) Have the vehicle operator move the right SUSPENSION CONTROL lever to RAISE until transducer T1 reads greater than 3000 psig. (This indicates that V15 has directed flow from the suspension circuit to transducer T1.)

17. Valve V16 check:

- a) Push the RESET VALVES button on the control box, and verify all the valves are set to the power OFF setting and are in the default position. Reference Table A-1.
- b) Use the LINE UP and LINE DOWN buttons to select valve V16. Press CHANGE POSITION to close valve V16.
- c) Have the vehicle operator move the left SUSPENSION CONTROL lever to LOWER until transducer T1 reads less than 500 psig.
- d) Have the vehicle operator move the left SUSPENSION CONTROL lever to RAISE until transducer T1 reads greater than 3000 psig. (This indicates that V16 has directed flow from the suspension circuit to transducer T1.)



**APPENDIX A**  
**M9 ACE HDC**  
**MWO CHECK-OUT PROCEDURE - CONTINUED**

## 18. Valve V17 check:

- a) Push the RESET VALVES button on the control box, and verify all the valves are set to the power OFF setting and are in the default position. Reference Table A-1.
- b) Use the LINE UP and LINE DOWN buttons to select valve V17. Press CHANGE POSITION to close valve V17.
- c) Have the vehicle operator move the apron control lever to LOWER until transducer T1 reads less than 500 psig.
- d) Have the vehicle operator move the apron control lever to RAISE until transducer T1 reads greater than 3000 psig. (This indicates that V17 has directed flow from the apron circuit to transducer T1.)

## 19. Valve V1 check:

- a) Turn off the control box by depressing the POWER button.
- b) Have the vehicle operator stop the engine.
- c) Open valve V23 by moving the handle to a vertical position.
- d) Have the vehicle operator start the engine.
- e) Power up the HDC control box by pressing the POWER button.
- f) Use the LINE UP and LINE DOWN buttons to select valve V1. Press CHANGE POSITION to close valve V1.
- g) Have vehicle operator move the EJECTOR CONTROL lever forward and backward. Ensure that the ejector does not move. (This indicates that valve V1 has closed.)
- h) Push the RESET VALVES button on the control box, and verify all the valves are set to the power OFF setting and are in the default position. Reference Table A-1.

20. When the MWO check-out procedure is complete, shut down the vehicle per TM 5-2350-262-10.

21. Disconnect the HDC control box and umbilical cable assembly W4 from the umbilical cable disconnect panel.

22. Stow umbilical cable assembly W4, 12496956, in a clean, dry area of vehicle, protected from environment.

23. Secure HDC control box in stowage fixture in driver's compartment.

**NOTE**

The information on the following pages provides preliminary operating instructions for the M9 ACE Hydraulic Diagnostic Center (HDC). Complete information for using the HDC is provided in TM 5-2350-378-24&P.

## APPENDIX A M9 ACE HDC MWO CHECK-OUT PROCEDURE - CONTINUED

### M9 ACE Hydraulic Diagnostic Center (HDC)

#### Preliminary Operating Instructions

(For Final Operating Instructions, see TM 5-2350-378-24&P)

#### NOTE

Connectors P1 through P6 are all keyed differently, and cannot be connected to the wrong mating connector.

1. Connect HDC umbilical harness connectors P4, P5, and P6 to the connectors on the disconnect bracket in forward left area of the driver's compartment.
2. Connect HDC umbilical harness connectors P1, P2, and P3 to the connectors on the HDC control box.
3. With the vehicle engine running and the transmission in neutral, turn the control box on by pressing the POWER button. (Depressing the POWER button again will turn the HDC control box off.) Note that:
  - a. Power to the HDC system is disconnected if the vehicle is taken out of neutral.
  - b. The valves will return to their normal vehicle operating positions when the control box is turned off (or power is disconnected).

The default valve display (all valves in the OFF position) looks as follows:

VALVE NO.	PWR	/	POSITION
V1	OFF	/	OPEN
V2	OFF	/	OPEN
V3	OFF	/	OPEN
V4	OFF	/	OPEN
V5	OFF	/	OPEN
V6	OFF	/	OPEN
V7	OFF	/	OPEN
V8	OFF	/	OPEN
V9	OFF	/	OPEN
V10	OFF	/	OPEN
V11	OFF	/	OPEN
V12	OFF	/	OPEN
V13	OFF	/	OPEN
V14	OFF	/	OPEN
V15	OFF	/	OPEN
V16	OFF	/	OPEN
V17	OFF	/	OPEN
V18	OFF	/	CLOSED
V19	OFF	/	CLOSED
V20	OFF	/	CLOSED

**APPENDIX A**  
**M9 ACE HDC**  
**MWO CHECK-OUT PROCEDURE - CONTINUED**

4. Valves V1 through V20 can be opened and closed by using the LINE UP and LINE DOWN buttons to select a valve, and then pressing the CHANGE POSITION button to open or close the valve. The control box software allows up to four of the solenoid valves (V1-V20) may be powered ON at one time. Pressing the RESET VALVES button returns all valves to their normal vehicle operating position (power OFF).
5. Valves V21 and V22 are manually operated, and are located in the bowl area, near the high pressure filters. They can be operated from outside the bowl, while standing on top of the vehicle.
6. Valve V23 is manually operated, and is located in the bowl area, on the front of the directional control valve bank. It is operated while standing in the bowl. This valve is used to interrupt flow to the ejector. **It is recommended that the engine be shut down when operating valve V23, for safety purposes.**
7. The troubleshooting instructions listed in TM 5-2350-378-24&P show how to use the HDC system to troubleshoot the M9 ACE vehicle hydraulic system in those M9 ACE vehicles equipped with the HDC system.

**WARNING**

Do not perform MWO check out procedure of the V23 valve manually unless the engine is shut off. If the engine is running and not shut off, failure may result in serious injury or death to personnel in the bowl.



## APPENDIX B HULL/EJECTOR INTERFERENCE MODIFICATION

**PURPOSE:**

The purpose of the Hull/Ejector Interference Modification is to eliminate contact between the new pressure relief valves, located below the main hydraulic filters, and the ejector when it is fully retracted. This is accomplished by adding a spacer block behind the ejector cylinder mount. To accommodate the extra travel distance of the ejector rollers when the ejector is fully extended, wheel support wedges are welded to the hull in bowl area.

**Table B-1. Hull/Ejector Interference Modification Parts List**

Part No.	CAGE	NSN	Description	Qty
<b>NEW PARTS</b>				
MS51095-446	96906	5306-01-206-8396	Bolt, Machine	4
<b>REMOVE AND DISCARD</b>				
B1821BH063C175L	80204	5306011972532	Bolt, Machine	4

This appendix also includes instructions for making items authorized to be manufactured at unit maintenance level.

**MANUFACTURED ITEMS LIST:**

<u>ITEM</u>	<u>PART NUMBER</u>	<u>REFERENCE</u>
Wheel Support Wedge 1	2488668	Figure B-1
Spacer Plate Ejector Cylinder Mount	12488667	Figure B-2

**MANUFACTURED ITEMS**

**NOTES:**

1. APPLICABLE STANDARDS/SPECIFICATIONS:
  - A. ASME Y14.100-2000
  - B. ASME Y14.5M-1994
2. MATERIAL: ALUMINUM, ALLOY, 5083 SPEC MIL-DTL-46027, 3.0" THICK.
3. ALL EDGES AND CORNERS SHALL BE FREE FROM BURRS.

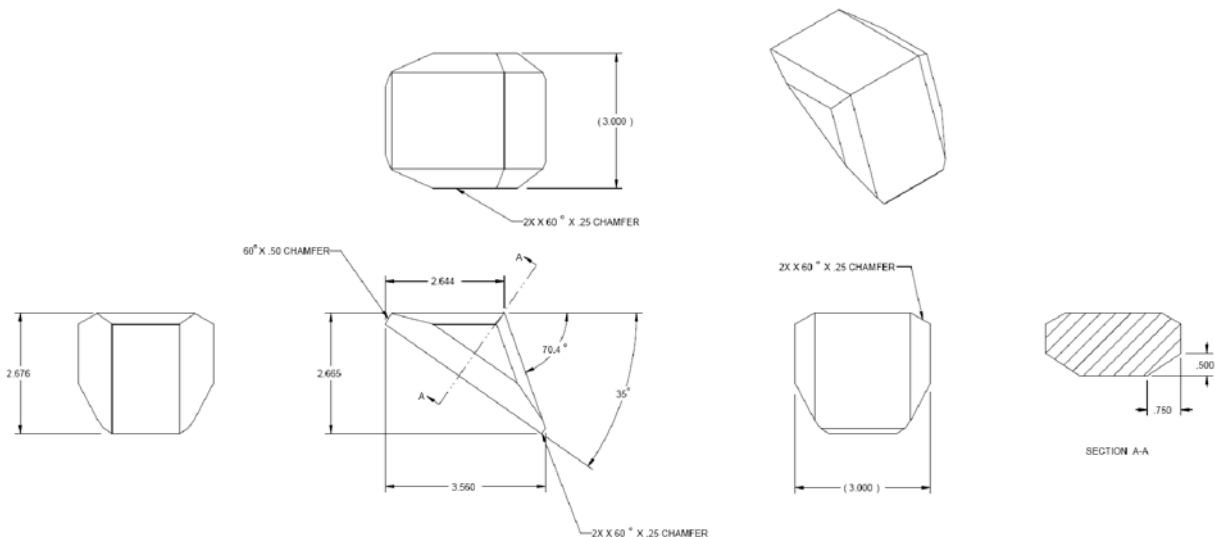

**Figure B-1. Dimensional drawing for fabricating Wheel Support Wedge**

## APPENDIX B HULL/EJECTOR INTERFERENCE MODIFICATION - CONTINUED

### MANUFACTURED ITEMS - CONTINUED

#### NOTES:

1. APPLICABLE STANDARDS/SPECIFICATIONS:
  - A. ASME Y14.100-2000
  - B. ASME Y14.5M-1994
2. MATERIAL: ALUMINUM, ALLOY, 5083 SPEC MIL-DTL-46027, 2.0" THICK.
3. ALL EDGES AND CORNERS SHALL BE FREE FROM BURRS.

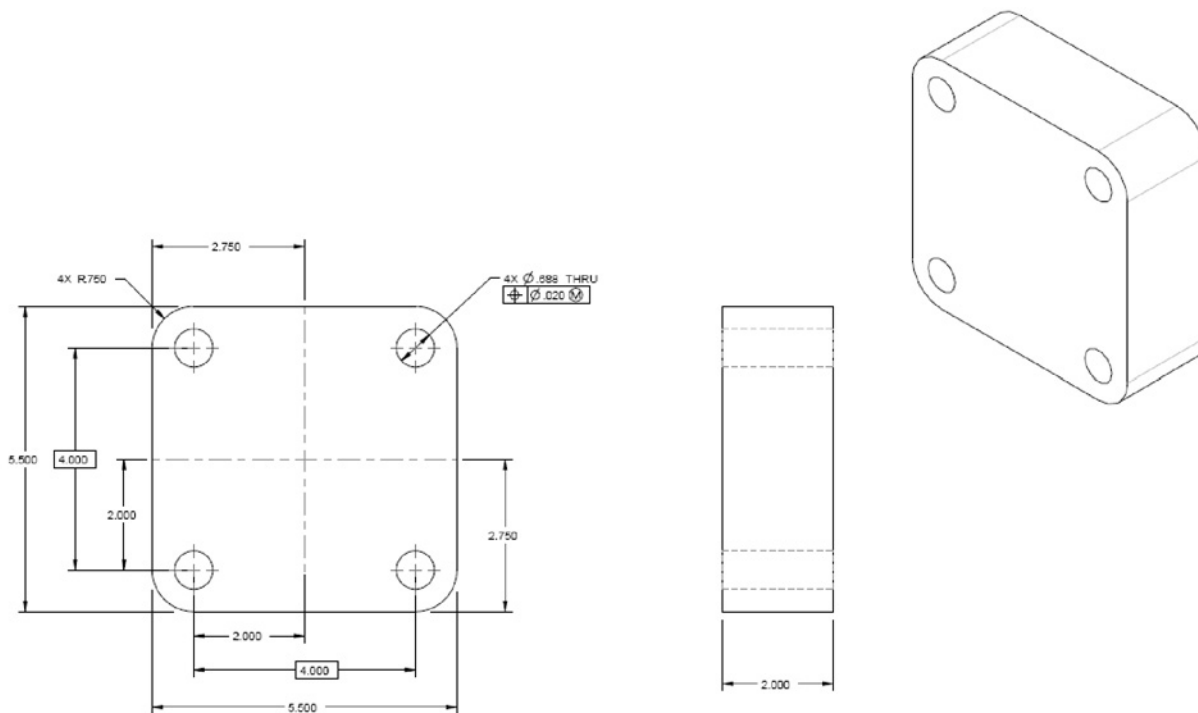

Figure B-2. Dimensional drawing for fabricating Ejector cylinder Mount Spacer Plate

## APPENDIX B

### HULL/EJECTOR INTERFERENCE MODIFICATION - CONTINUED

#### WHEEL SUPPORT WEDGE PROCEDURE

#### WARNING

Do not operate ejector when personnel are in bowl. Do not stand or work in bowl unless ejector lock is engaged. Do not stand in bowl to observe roller guide travels. Failure to comply may result in serious injury or death to personnel.

- Preface surface on both sides of bowl area where wheel support wedges, 12488668, (1) will be welded.
- Position wedge (1) against side of bowl. Grind as necessary to ensure snug fit against side of bowl.
- Using a straight edge, align top of wedge (1) with surface of bowl as shown below.
- Weld wheel support wedge in place in accordance with standard welding guidelines.

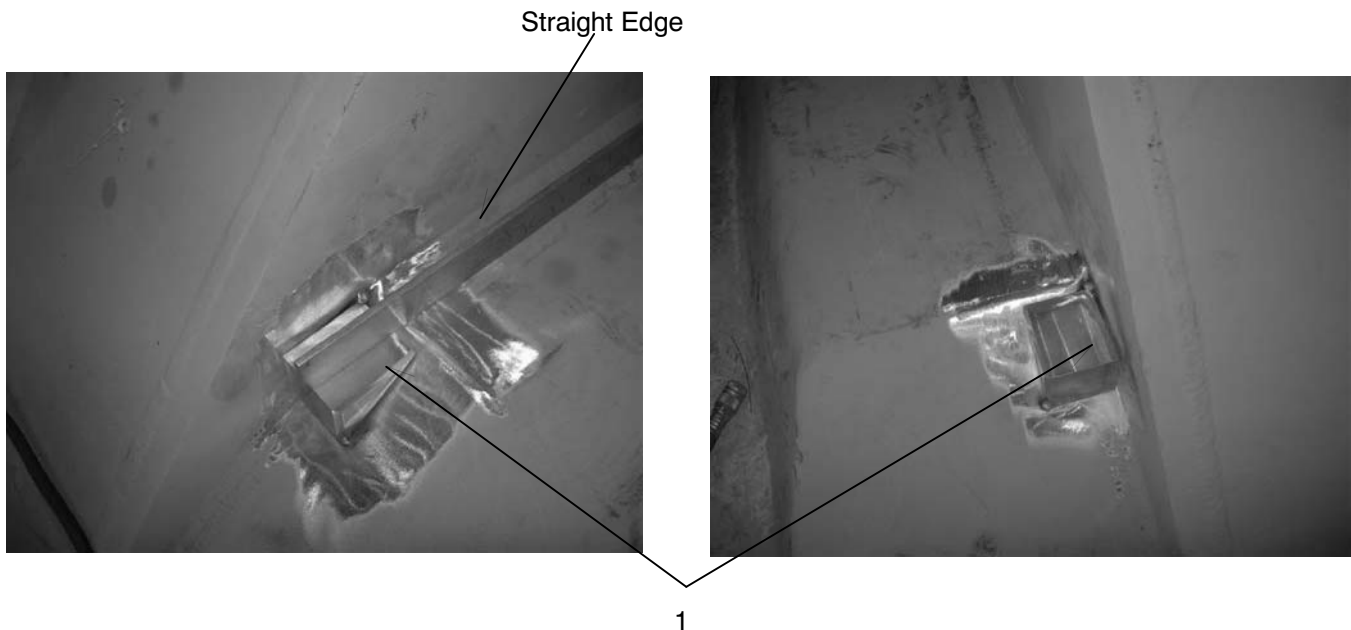

**Figure B-3. Right and Left side Wheel Support Wedge Locations**



**Figure B-4. Wheel Support Wedge Welded in Position**

## APPENDIX B HULL/EJECTOR INTERFERENCE MODIFICATION - CONTINUED

- a. Remove rear floor plates per TM-5-2350-20-1.

### WARNING

Ejector cylinder weighs 325 lb (148 kg). Support ejector cylinder with blocks or straps while it is being moved. Do not put hands or feet under ejector cylinder while it is being moved.

- b. Remove ejector cylinder bracket (1) per TM-5-2350-20-1.

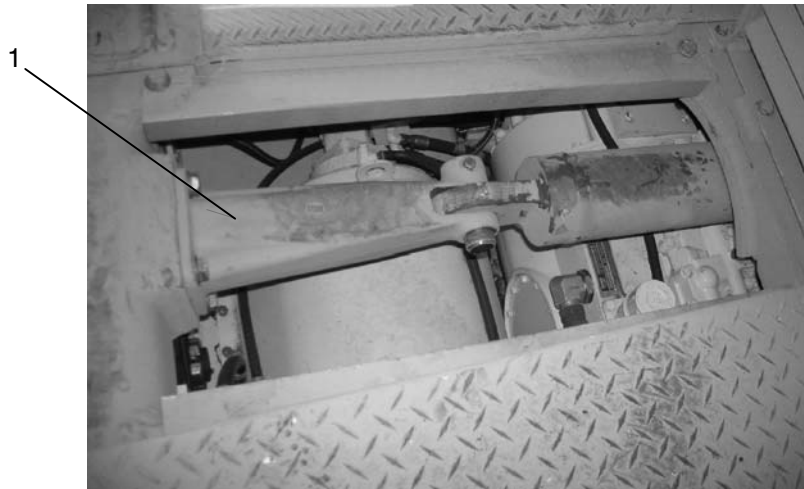

**Figure B-5. Ejector Cylinder Bracket Removal**

- c. Install spacer block, 12488667, (2) and bracket (3) on hull with four flat washers, MS9320-16, (4) and new hex head cap screws, B1821BH063C375L, (5). Tighten screws to 123-135 lb-ft (167-183 N•m).



**Figure B-6. Spacer Block Installed**

- d. Install bracket (3) to rear ejector cylinder end per TM-5-2350-20-1.  
e. Install rear floor plates per TM-5-2350-20-1.



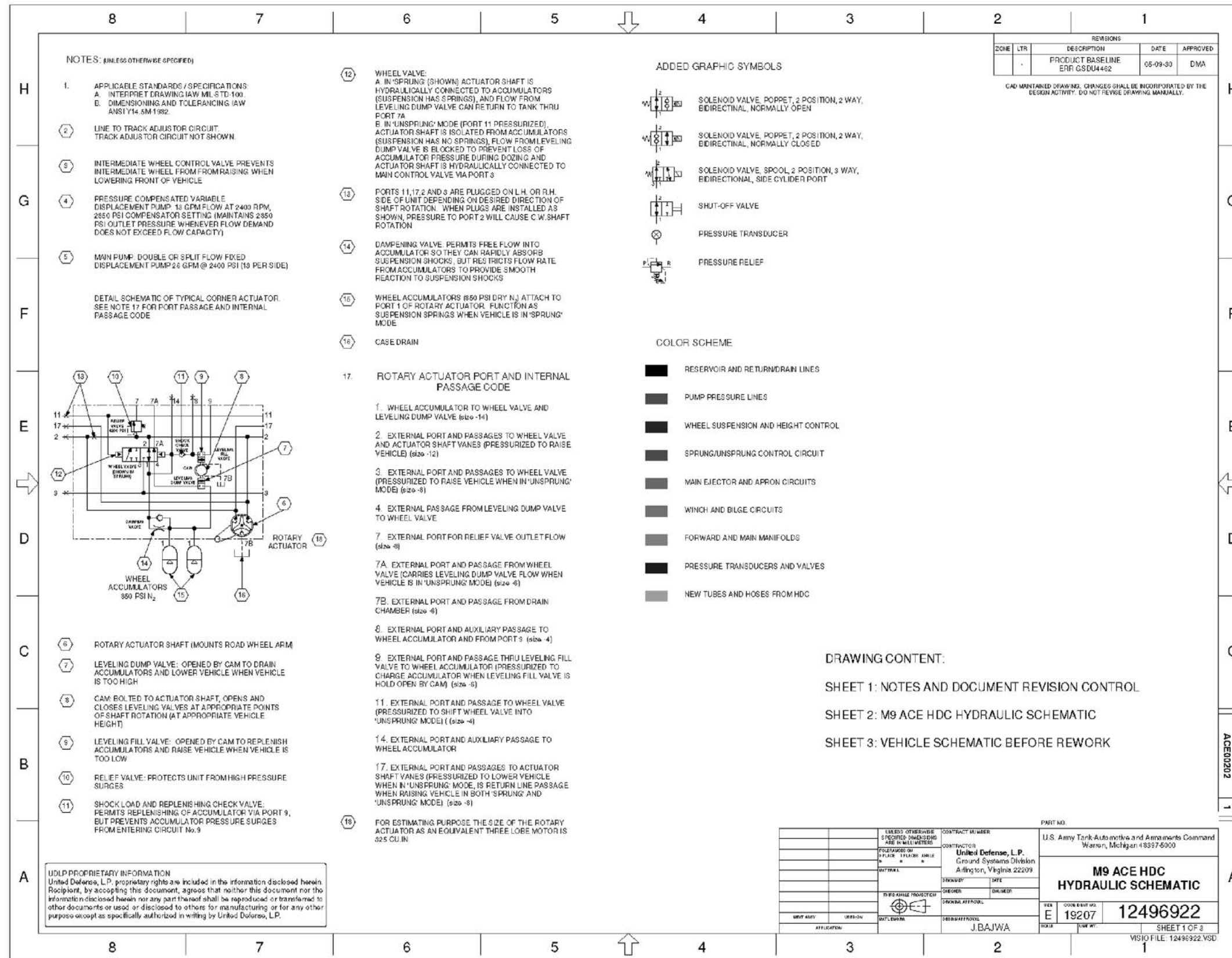



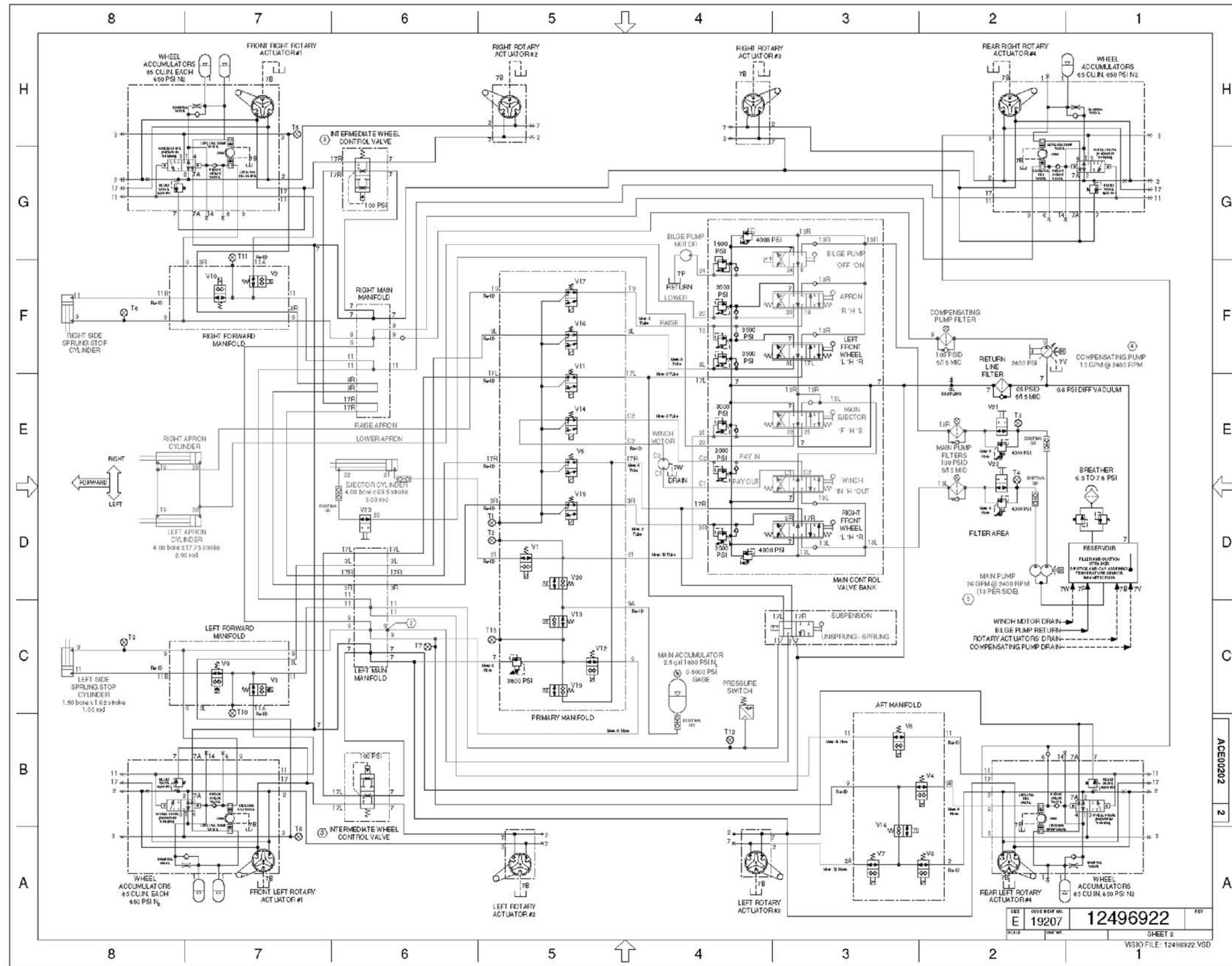

FO 3-1. 2 of 3 M9 ACE HDC  
HYDRAULIC SCHEMATIC  
FP-3/(FP-4 blank)



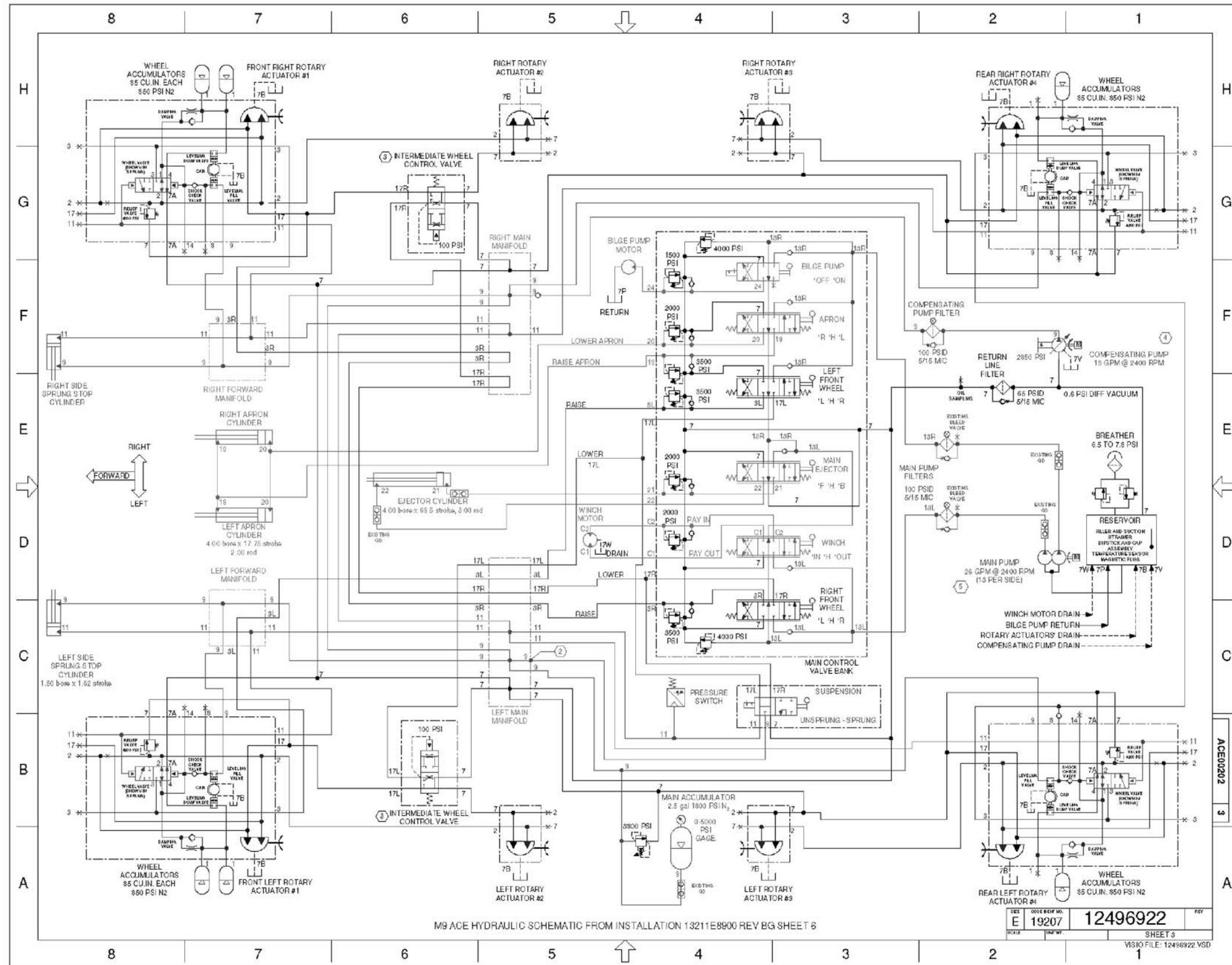

M9 ACE HYDRAULIC SCHEMATIC FROM INSTALLATION 13211E8900 REV BG SHEET 6

SEE E 19207	12496922	REV
SHEET 3		
VSD FILE: 12496922.VSD		



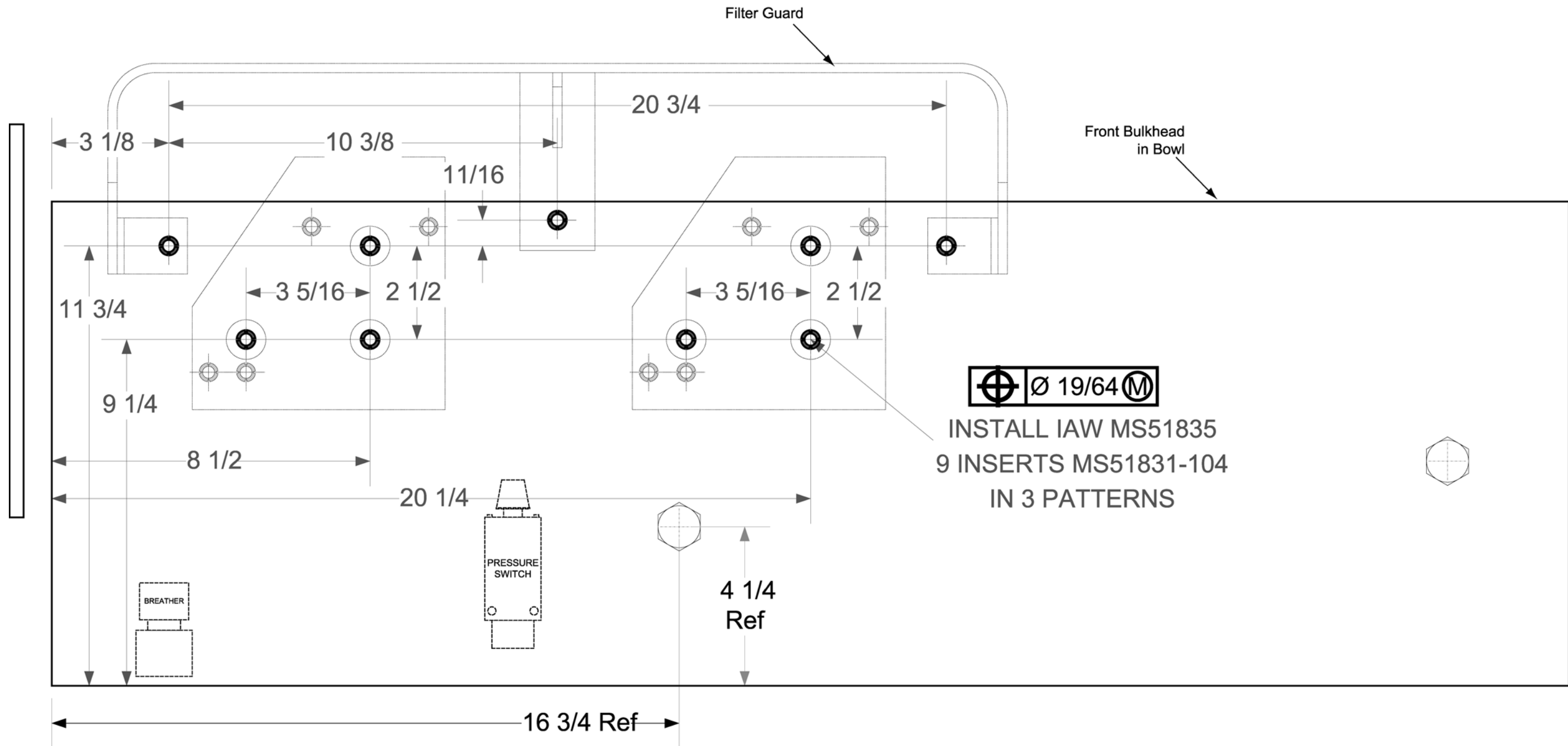





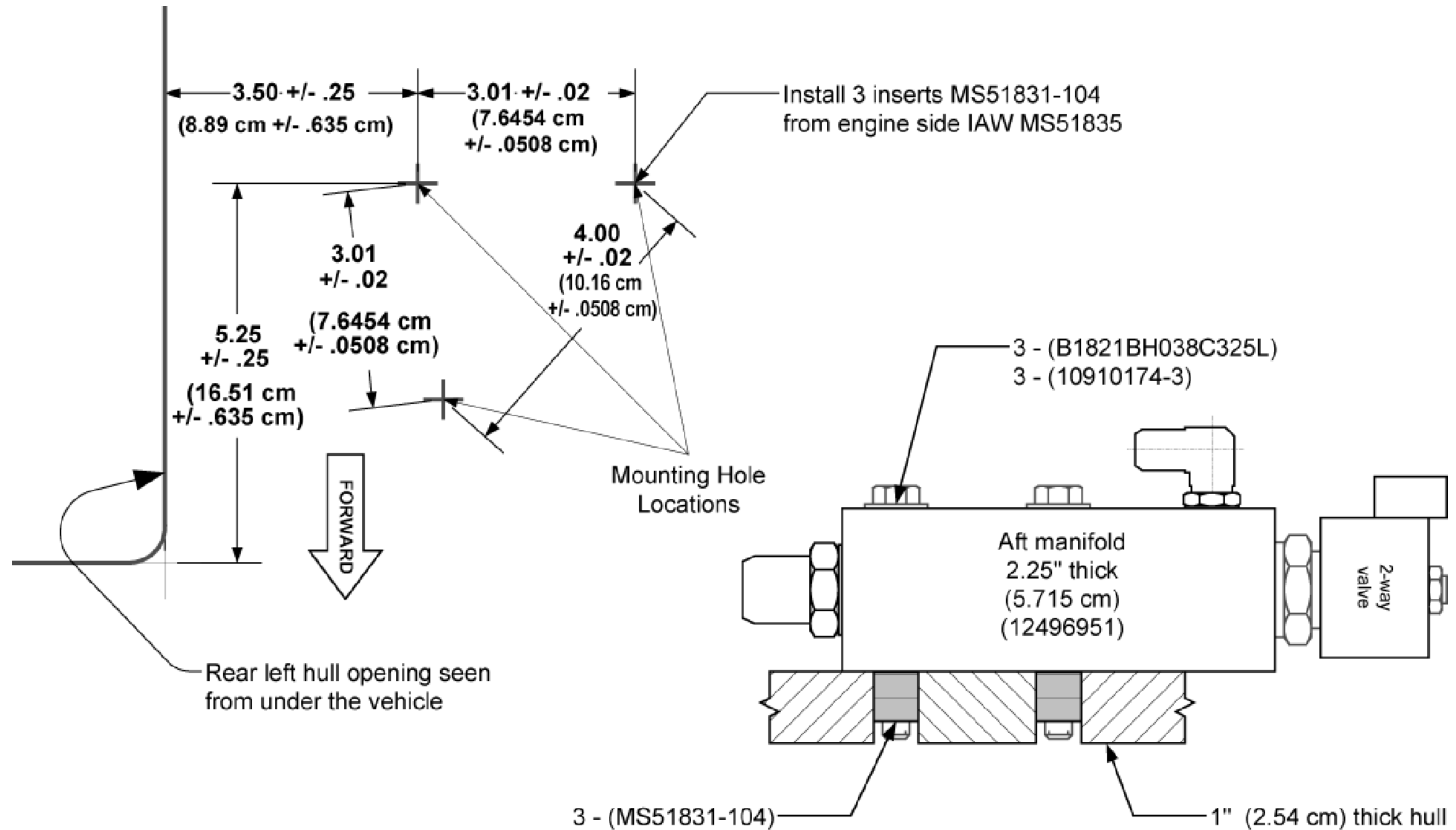

## Mounting the Aft Manifold to a 1" (2.54 cm) thick hull



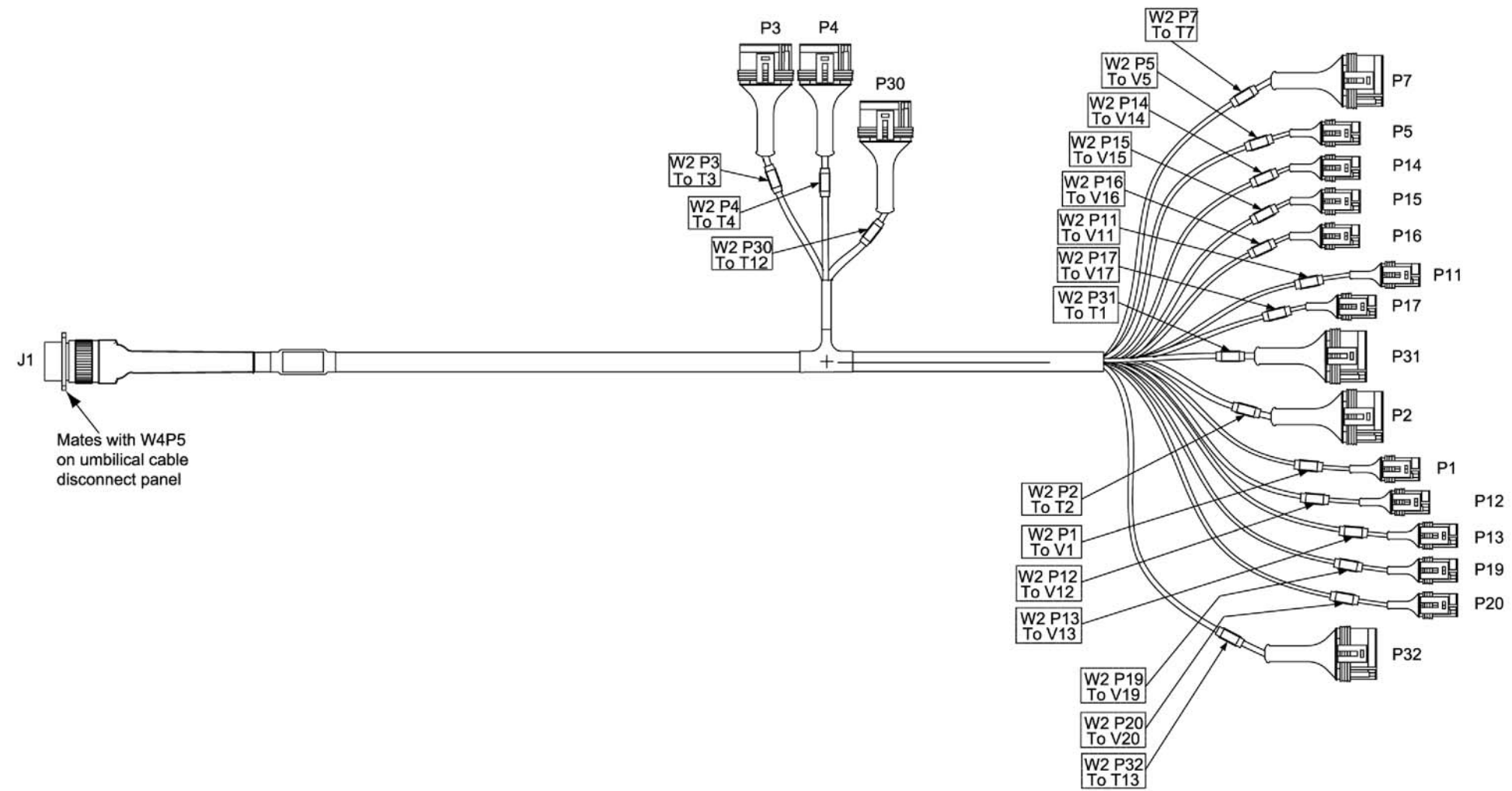



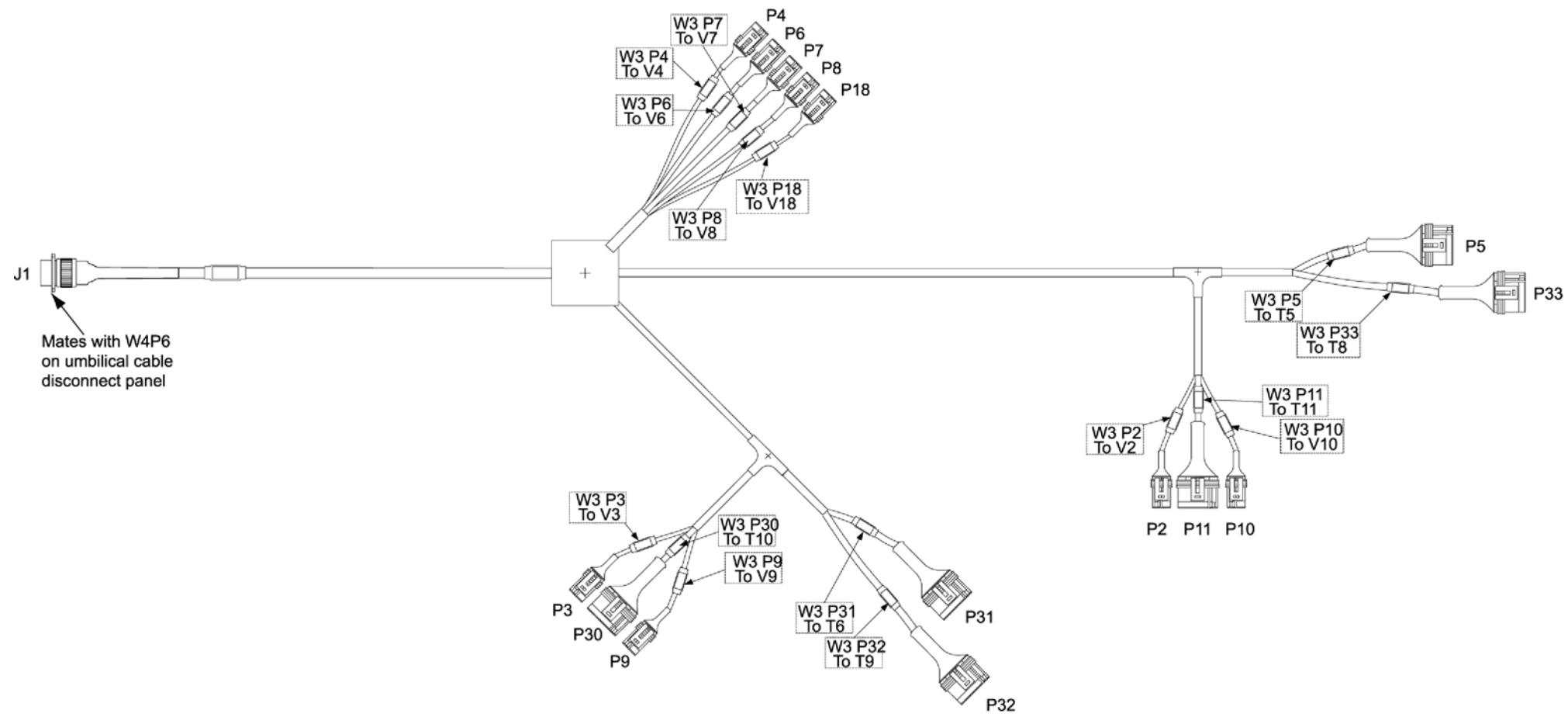



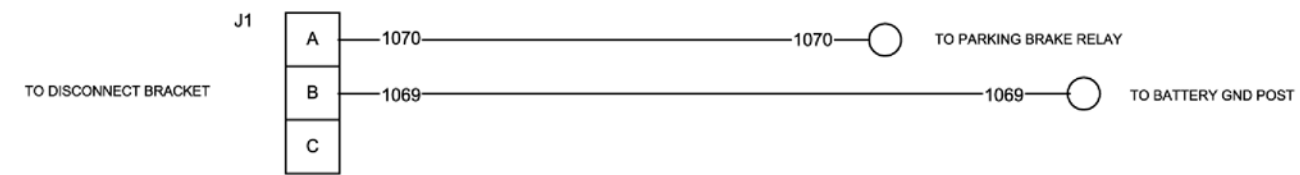
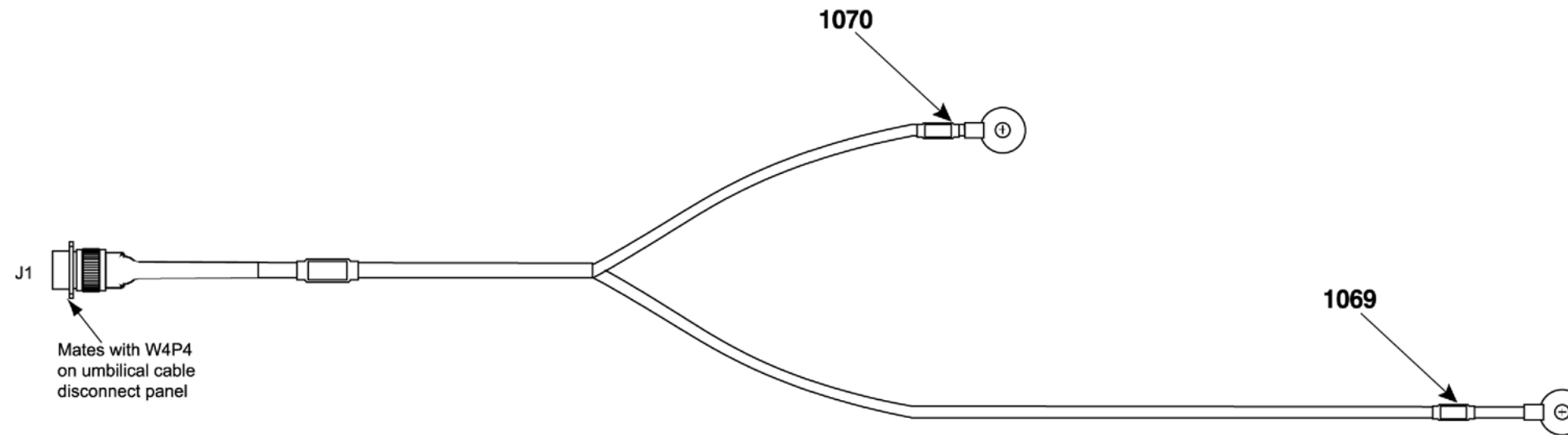





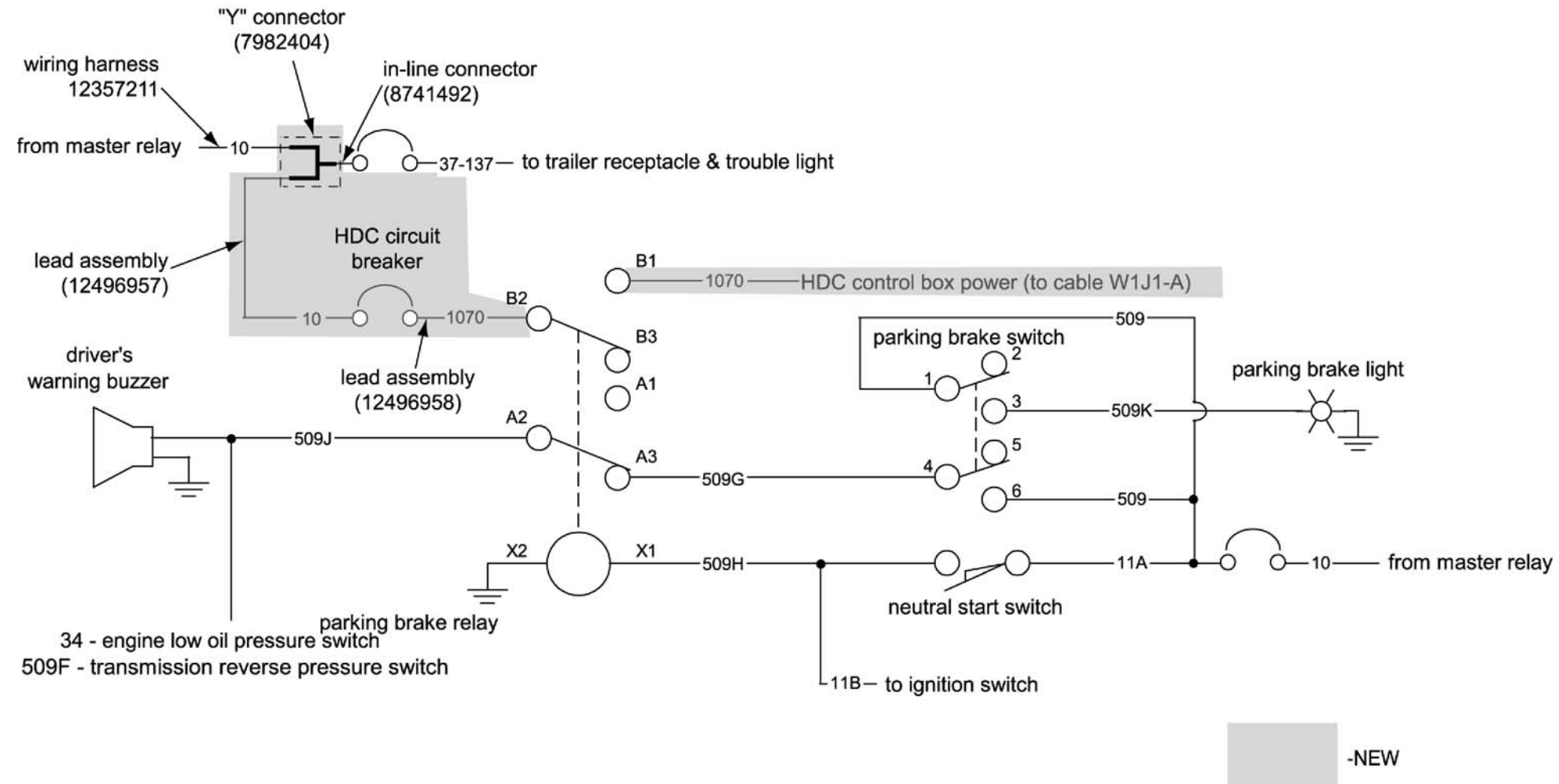

FO 5-4. SIMPLIFIED ELECTRICAL SCHEMATIC  
 DIAGRAM OF HDC SYSTEM POWER  
 DISTRIBUTION  
 FP-17/(FP-18 blank)



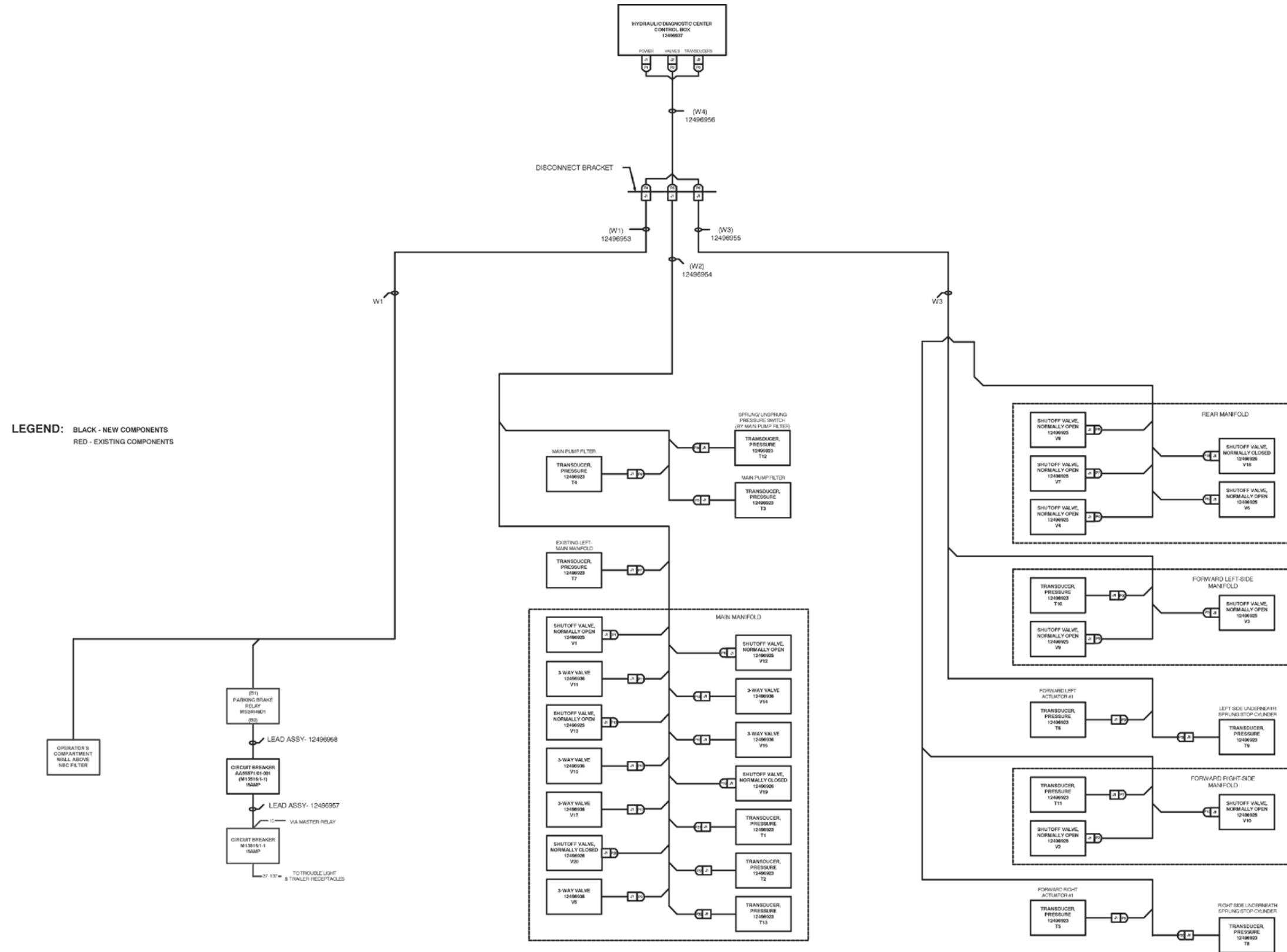

FO 5-5. HDC SYSTEM ELECTRICAL INTERCONNECTION DIAGRAM FP-19/(FP-20 blank)



By Order of the Secretary of the Army:

GEORGE W. CASEY, JR.  
*General, United States Army*  
*Chief of Staff*

Official:  
  
JOYCE E. MORROW  
*Administrative Assistant to the*  
*Secretary of the Army*  
0827409

Distribution:

To be distributed in accordance with the initial distribution number (IDN) 381210,  
requirements for MWO 5-2350-262-35-4.



<b>RECOMMENDED CHANGES TO PUBLICATIONS AND BLANK FORMS</b> <small>For use of this form, see AF 25-32; the proponent agency is DAASA</small>						Use Part II (reverse) for Repair Parts and Special Tool Lists (RPSTL) and Supply Catalogs/Supply Manuals (SC/SM).	DATE
TO: <i>(Forward to proponent of publication or form) (Include ZIP Code)</i>						FROM: <i>(Activity and location) (Include ZIP Code)</i>	
<b>PART I - ALL PUBLICATIONS (EXCEPT RPSTL AND SC/SM) AND BLANK FORMS</b>							
PUBLICATION/FORM NUMBER						DATE	TITLE
ITEM	PAGE	PARA-GRAPH	LINE	FIGURE NO.	TABLE	RECOMMENDED CHANGES AND REASON	
<small>* Reference to line numbers within the paragraph or subparagraph.</small>							
TYPED NAME, GRADE OR TITLE						TELEPHONE EXCHANGE/AUTOVON, PLUS EXTENSION	SIGNATURE

TO: <i>(Forward direct to addressee listed in publication)</i>			FROM: <i>(Activity and location) (Include ZIP Code)</i>				DATE	
<b>PART II - REPAIR PARTS AND SPECIAL TOOL LISTS AND SUPPLY CATALOGS/SUPPLY MANUALS</b>								
PUBLICATION NUMBER				DATE		TITLE		
PAGE NO.	COLM NO.	LINE NO.	NATIONAL STOCK NUMBER	REFERENCE NO.	FIGURE NO.	ITEM NO.	TOTAL NO. OF MAJOR ITEMS SUPPORTED	RECOMMENDED ACTION
<b>PART III - REMARKS</b> <i>(Any general remarks or recommendations, or suggestions for improvement of publications and blank forms. Additional blank sheets may be used if more space is needed.)</i>								
TYPED NAME, GRADE OR TITLE				TELEPHONE EXCHANGE/AUTOVON. PLUS EXTENSION			SIGNATURE	



<b>RECOMMENDED CHANGES TO PUBLICATIONS AND BLANK FORMS</b> <small>For use of this form, see AF 25-32; the proponent agency is DAASA</small>						Use Part II (reverse) for Repair Parts and Special Tool Lists (RPSTL) and Supply Catalogs/Supply Manuals (SC/SM).	DATE
TO: <i>(Forward to proponent of publication or form) (Include ZIP Code)</i>						FROM: <i>(Activity and location) (Include ZIP Code)</i>	
<b>PART I - ALL PUBLICATIONS (EXCEPT RPSTL AND SC/SM) AND BLANK FORMS</b>							
PUBLICATION/FORM NUMBER						DATE	TITLE
ITEM	PAGE	PARA-GRAPH	LINE	FIGURE NO.	TABLE	RECOMMENDED CHANGES AND REASON	
<small>* Reference to line numbers within the paragraph or subparagraph.</small>							
TYPED NAME, GRADE OR TITLE						TELEPHONE EXCHANGE/AUTOVON, PLUS EXTENSION	SIGNATURE

TO: <i>(Forward direct to addressee listed in publication)</i>			FROM: <i>(Activity and location) (Include ZIP Code)</i>				DATE	
<b>PART II - REPAIR PARTS AND SPECIAL TOOL LISTS AND SUPPLY CATALOGS/SUPPLY MANUALS</b>								
PUBLICATION NUMBER				DATE			TITLE	
PAGE NO.	COLM NO.	LINE NO.	NATIONAL STOCK NUMBER	REFERENCE NO.	FIGURE NO.	ITEM NO.	TOTAL NO. OF MAJOR ITEMS SUPPORTED	RECOMMENDED ACTION
<b>PART III - REMARKS</b> <i>(Any general remarks or recommendations, or suggestions for improvement of publications and blank forms. Additional blank sheets may be used if more space is needed.)</i>								
TYPED NAME, GRADE OR TITLE				TELEPHONE EXCHANGE/AUTOVON, PLUS EXTENSION			SIGNATURE	

<b>RECOMMENDED CHANGES TO PUBLICATIONS AND BLANK FORMS</b> <small>For use of this form, see AF 25-32; the proponent agency is DAASA</small>						Use Part II (reverse) for Repair Parts and Special Tool Lists (RPSTL) and Supply Catalogs/Supply Manuals (SC/SM).	DATE
TO: <i>(Forward to proponent of publication or form) (Include ZIP Code)</i>						FROM: <i>(Activity and location) (Include ZIP Code)</i>	
<b>PART I - ALL PUBLICATIONS (EXCEPT RPSTL AND SC/SM) AND BLANK FORMS</b>							
PUBLICATION/FORM NUMBER						DATE	TITLE
ITEM	PAGE	PARA-GRAPH	LINE	FIGURE NO.	TABLE	RECOMMENDED CHANGES AND REASON	
<small>* Reference to line numbers within the paragraph or subparagraph.</small>							
TYPED NAME, GRADE OR TITLE						TELEPHONE EXCHANGE/AUTOVON, PLUS EXTENSION	SIGNATURE

TO: <i>(Forward direct to addressee listed in publication)</i>			FROM: <i>(Activity and location) (Include ZIP Code)</i>				DATE	
<b>PART II - REPAIR PARTS AND SPECIAL TOOL LISTS AND SUPPLY CATALOGS/SUPPLY MANUALS</b>								
PUBLICATION NUMBER				DATE			TITLE	
PAGE NO.	COLM NO.	LINE NO.	NATIONAL STOCK NUMBER	REFERENCE NO.	FIGURE NO.	ITEM NO.	TOTAL NO. OF MAJOR ITEMS SUPPORTED	RECOMMENDED ACTION
<b>PART III - REMARKS</b> <i>(Any general remarks or recommendations, or suggestions for improvement of publications and blank forms. Additional blank sheets may be used if more space is needed.)</i>								
TYPED NAME, GRADE OR TITLE				TELEPHONE EXCHANGE/AUTOVON, PLUS EXTENSION			SIGNATURE	

USAPA V3.01

PIN: 084318-000